

MAIN SWITCHES, CONTROL SWITCHES, COMMAND AND SIGNALLING DEVICES

COMMAND AND SIGNALLING DEVICES SERIES MM – GENERAL INFORMATION



SERIES MM

Actuating and signalling elements

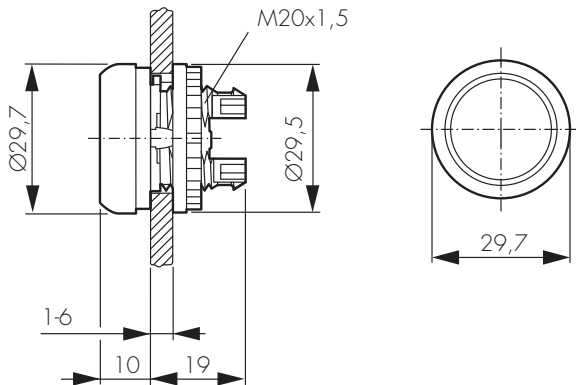

SCHRACK INFO

- Full LED technology
- 100,000 h service life
- 3 LEDs for 5 colours
- Spring terminals for contact and LED elements
- Degree of protection
IP 67/69 K for pushbuttons, illuminated pushbuttons and signal lamps; emergency stop buttons, mushroom pushbuttons
IP 66 for double pushbuttons, selector and key switches
- Abrasion-proof laser labelling
- Database (1000 symbols)
- Custom symbols will be scaled to size
- Individual text possible
- 3 mm font height, 3 lines possible
 1. 8 characters
 2. 10 characters
 3. 8 characters
- 5 mm font height, one line with 5 characters
- Programmable stay-put and spring-return function
- 22.5 mm diameter

MAIN SWITCHES, CONTROL SWITCHES, COMMAND AND SIGNALLING DEVICES

SYSTEM OVERVIEW SERIES MM

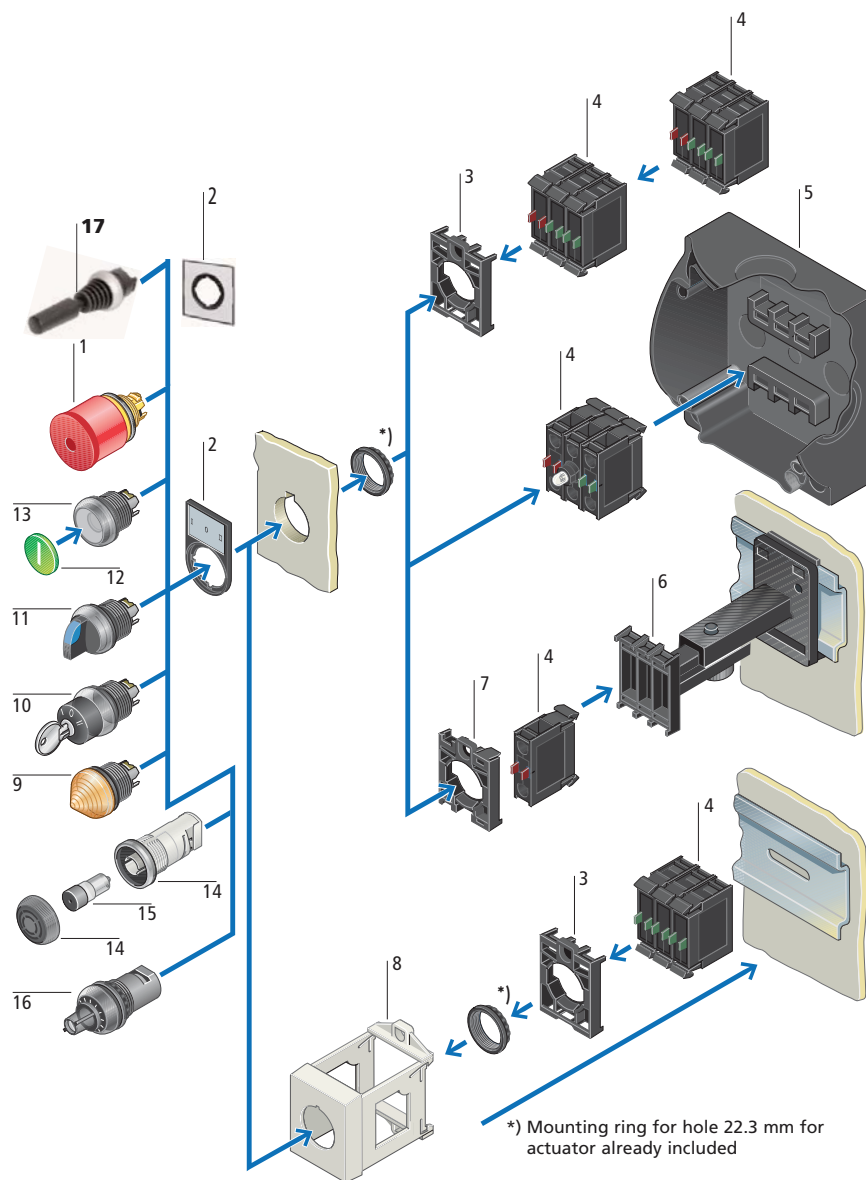

- | | | | |
|---|------------------------|----|--------------------------------|
| 1 | Emergency stop buttons | 9 | Indicator light |
| 2 | Label holder | 10 | Key buttons |
| 3 | Mounting adapter | 11 | Selector switch |
| 4 | Contact elements | 12 | Button plates / buttons lenses |
| 5 | Encapsulation | 13 | Pushbuttons |
| 6 | Telescopic clip | 14 | Acoustic indicator |
| 7 | Centring adapter | 15 | Buzzers |
| 8 | DIN rail adapter | 16 | Potentiometers |
| | | 17 | Joystick |

MAIN SWITCHES, CONTROL SWITCHES, COMMAND AND SIGNALLING DEVICES

SERIES MM – SETS



MM900002

SCHRACK INFO

- Pre-configured sets consisting of:
 - Command or signalling device
 - Mounting adapter
 - Light sources
 - Auxiliary contacts

DESCRIPTION	EAN CODE	AVAILABLE	ORDER NO.
ILLUMINATED PUSHBUTTON, GREEN, 230 V consisting of: Illuminated pushbutton, flat, spring-return, green, mounting adapter, front, LED 85-264 V AC, green, front, NO contact front	9004840614442		MM900001
ILLUMINATED PUSHBUTTON, RED, 230V consisting of: Illuminated pushbutton, flat, spring-return, red, mounting adapter front, LED 85-264 V AC red, front, NC contact front	9004840614459		MM900002
ILLUMINATED PUSHBUTTON, GREEN, 24V consisting of: Illuminated pushbutton, flat, spring-return, green, mounting adapter front, LED 12-30 V AC/DC, green, front, NO contact front	9004840614466		MM900003
ILLUMINATED PUSHBUTTON, RED, 24V consisting of: Illuminated pushbutton, flat, spring-return, red, mounting adapter front, LED 12-30 V AC/DC red, front, NC contact front	9004840614473		MM900004
INDICATOR LIGHT, FLAT, GREEN, 230 V consisting of: Signal lamp flat, green, mounting adapter front, LED 85-264 V AC, green, front	9004840614480		MM900005
INDICATOR LIGHT, FLAT, RED, 230 V consisting of: Signal lamp, flat, red, mounting adapter front, LED 85-264 V AC red, front	9004840614497		MM900006
INDICATOR LIGHT, FLAT, GREEN, 24V consisting of: Signal lamp flat, green, mounting adapter front, LED 12-30 V AC/DC, green, front	9004840614503		MM900007
INDICATOR LIGHT, FLAT, RED, 24V consisting of: Signal lamp, flat, red, mounting adapter front, LED 12-30 V AC/DC red, front	9004840614510		MM900008
PUSHBUTTON, GREEN, consisting of: Pushbutton, flat, spring-return, green, mounting adapter front, NO contact front	9004840614527		MM900009
PUSHBUTTON, RED, consisting of: Pushbutton, flat, spring-return, red, mounting adapter front, NO contact front	9004840614534		MM900010
EMERGENCY STOP consisting of: Emergency stop button, mounting adapter front, NC contact front	9004840614541		MM900011
SELECTOR SWITCH, 2 POSITIONS STAY-PUT, dia. 60 consisting of: T-handle switch, 2 positions r, dia. 60, mounting adapter front, NO contact front, NC contact front	9004840614558		MM900012
SELECTOR SWITCH, 3 POSITIONS STAY-PUT, dia. 60 consisting of: T-handle switch, 3 positions r, dia. 60, mounting adapter front, NO contact front, NC contact front	9004840614565		MM900013
DOUBLE PUSHBUTTON, GREEN/RED, 230 V consisting of: Double pushbutton, illuminated, spring-return, green/red, "I-O", mounting adapter front, LED 85-264 V AC ws front, NO contact front, NC contact front	9004840614572		MM900014
DOUBLE PUSHBUTTON, GREEN/RED, 24 V consisting of: Double pushbutton, illuminated, spring-return, green/red, "I-O", mounting adapter front, LED 12-30 V AC/DC ws front, NO contact front, NC contact front	9004840614589		MM900015
KEY OPERATED BUTTON, 2 POSITIONS STAY-PUT, dia. 40 consisting of: Key switch, 2 positions r, dia. 40, mounting adapter front, NO contact front, NC contact front	9004840614596		MM900016



MAIN SWITCHES, CONTROL SWITCHES, COMMAND AND SIGNALLING DEVICES

■ SERIES MM – PUSHBUTTONS, FLAT



MM216605

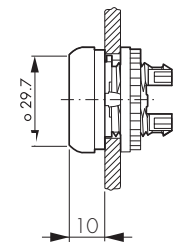

DIMENSIONS

■ SCHRACK INFO

- IP 67, 69K
- 22.5 mm diameter

■ TIPS & TRICKS

To obtain a pushbutton with custom label, use the pushbutton without button plate and insert a button plate with your desired text.

DESCRIPTION	WxHxD (mm)	EAN CODE	AVAILABLE	ORDER NO.
SPRING-RETURN				
Flat, spring-return, black	dia. 29.7x10	9004840175332		MM216590
Flat, spring-return, white	dia. 29.7x10	9004840175349		MM216592
Flat, spring-return, red	dia. 29.7x10	9004840175356		MM216594
Flat, spring-return, green	dia. 29.7x10	9004840175363		MM216596
Flat, spring-return, yellow	dia. 29.7x10	9004840175370		MM216598
Flat, spring-return, blue	dia. 29.7x10	9004840175387		MM216600
Flat, spring-return, red "0"	dia. 29.7x10	9004840175400		MM216605
Flat, spring-return, black "0"	dia. 29.7x10	9004840175424		MM216609
Flat, spring-return, green "1"	dia. 29.7x10	9004840175417		MM216607
Flat, spring-return, white "1"	dia. 29.7x10	9004840175431		MM216611
Flat, spring-return, without button plate	dia. 29.7x10	9004840175394		MM216602
STAY-PUT				
Flat, stay-put, black	dia. 29.7x10	9004840175448		MM216613
Flat, stay-put, red	dia. 29.7x10	9004840175462		MM216617
Flat, stay-put, green	dia. 29.7x10	9004840175479		MM216619
Flat, stay-put, white	dia. 29.7x10	9004840175455		MM216615
Flat, stay-put, blue	dia. 29.7x10	9004840175493		MM216623
Flat, stay-put, without button plate	dia. 29.7x10	9004840175509		MM216625
BUTTON PLATES, FLAT WITH INSCRIPTION				
Button plate, flat, black "Arrow"	dia. 22.5	9004840223873		MM218173
Button plate, flat, green "1"	dia. 22.5	9004840215359		MM218165
Button plate, flat, red "Stop"	dia. 22.5	9004840251616		MM218194
Button plate, flat, red "0"	dia. 22.5	9004840215335		MM218153
Button plate, flat, black "Up"	dia. 22.5	9004840224573		MM218185
Button plate, flat, black "Down"	dia. 22.5	9004840224580		MM218186
Button plate, flat, black "0"	dia. 22.5	9004840215342		MM218154
Button plate, flat, black "+"	dia. 22.5	9004840223859		MM218170
Button plate, flat, black "-"	dia. 22.5	9004840223866		MM218171



MAIN SWITCHES, CONTROL SWITCHES, COMMAND AND SIGNALLING DEVICES

■ SERIES MM – PUSHBUTTONS, HIGH



MM216641

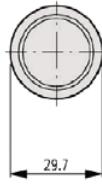

DIMENSIONS

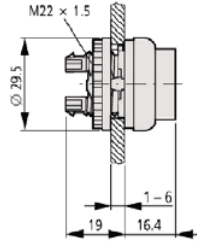

■ SCHRACK INFO

- IP 67, 69K
- 22.5 mm diameter

DESCRIPTION	WxHxD (mm)	EAN CODE	AVAILABLE	ORDER NO.
High, spring-return, black	dia. 29.7x16.4	9004840207200		MM216636
High, spring-return, red	dia. 29.7x16.4	9004840207224		MM216641
High, spring-return, green	dia. 29.7x16.4	9004840207231		MM216643
High, spring-return, blue	dia. 29.7x16.4	9004840207255		MM216649
High, spring-return, red, "0"	dia. 29.7x16.4	9004840177381		MM216655

■ SERIES MM – DOUBLE PUSHBUTTONS

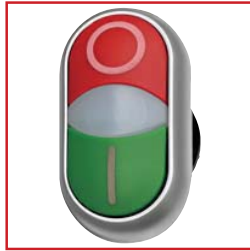

MM216700

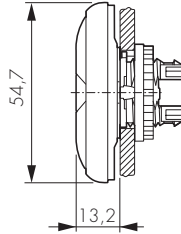

DIMENSIONS

■ SCHRACK INFO

- With signal lamp centre indicator lens, white
- LED can be retrofitted
- IP 66
- 22.5 mm diameter

DESCRIPTION	WxHxD (mm)	EAN CODE	AVAILABLE	ORDER NO.
Spring-return, illuminated, green/red	dia. 29.7x54.7x13.2	9004840175554		MM216698
Spring-return, illuminated, green/red, "1/0"	dia. 29.7x54.7x13.2	9004840175561		MM216700
Spring-return, illuminated, green/red, "Start/Stop"	dia. 29.7x54.7x13.2	9004840175578		MM216702
Spring-return, illuminated, white/black	dia. 29.7x54.7x13.2	9004840175585		MM216704
Spring-return, illuminated, white/black, "1/0"	dia. 29.7x54.7x13.2	9004840175592		MM216706
Spring-return, illuminated, white/black, "Start/Stop"	dia. 29.7x54.7x13.2	9004840175608		MM216708
Spring-return, illuminated, black/black, arrows	dia. 29.7x54.7x13.2	9004840175615		MM216710
Spring-return, illuminated, black/black, "+/-"	dia. 29.7x54.7x13.2	9004840175622		MM218145

MAIN SWITCHES, CONTROL SWITCHES, COMMAND AND SIGNALLING DEVICES

■ SERIES MM – MUSHROOM BUTTONS



MM216714

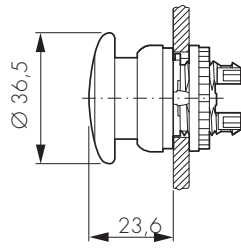

DIMENSIONS

■ SCHRACK INFO

- IP 67, 69K
- 22.5 mm diameter

DESCRIPTION	WxHxD (mm)	EAN CODE	AVAILABLE	ORDER NO.
SPRING-RETURN				
Spring-return, black	dia. 36.5x23.6	9004840175639		MM216712
Spring-return, red	dia. 36.5x23.6	9004840175646		MM216714
Spring-return, green	dia. 36.5x23.6	9004840175653		MM216716
Spring-return, yellow	dia. 36.5x23.6	9004840175660		MM216718
Spring-return, red, "0"	dia. 36.5x23.6	9004840175677		MM216720
STAY-PUT				
Stay-put, black	dia. 36.5x23.6	9004840207408		MM216743
Stay-put, red	dia. 36.5x23.6	9004840207415		MM216745

■ SERIES MM – BUTTON PLATES FOR MUSHROOM BUTTONS



MM216440

■ SCHRACK INFO

MM216440: To order a mushroom button with a custom label, use the button plate "MM216440-* - *" with order code and substitute the colour for the first asterisk and your desired text for the second asterisk.

Colour: -R...red, -G...green, -B...blue, W...white, -Y...yellow, -S...black

Text is possible in: 3 mm font height: 1st and 3rd line max. 8 characters, 2nd line 10 characters; 5 mm text height: 1 line max. 5 characters

■ ORDER SAMPLE

MM216440-G-POWER

(green button plate with 5 mm font, one line)

MM216440-Y-OIL PRESSURE WARNING

(yellow button plate with 3 mm font, two lines)

DESCRIPTION	WxHxD (mm)	EAN CODE	AVAILABLE	ORDER NO.
Button plate, mushroom buttons, red	dia. 22.5	9004840176827		MM216437
Button plate, mushroom buttons for custom labels	dia. 22.5	9004840176858		MM216440

■ SERIES MM – EMERGENCY STOP BUTTONS



MM216878

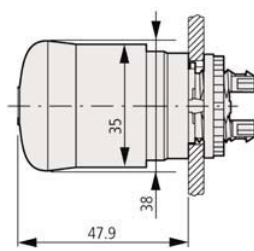

DIMENSIONS

■ SCHRACK INFO

- IP 67, IP 69K
- Overload protection in accordance with EN 418
- Return by pulling
- 22.5 mm diameter

DESCRIPTION	WxHxD (mm)	EAN CODE	AVAILABLE	ORDER NO.
Emergency stop button, non-illuminated	dia. 35x47.9	9004840175790		MM216876
Emergency stop button, illuminated	dia. 35x47.9	9004840175806		MM216878
Emergency stop button, non-illuminated, released by rotating	dia. 35x47.9	9004840622874		MM263467
Emergency stop key switch	dia. 35x47.9	9004840175813		MM216879



Order no. blue: on stock, usually ready for delivery on the day of order!

Скачано с сайта интернет магазина <https://axiomplus.com.ua>

MAIN SWITCHES, CONTROL SWITCHES, COMMAND AND SIGNALLING DEVICES

■ SERIES MM – KEY OPERATED BUTTONS



MM216900

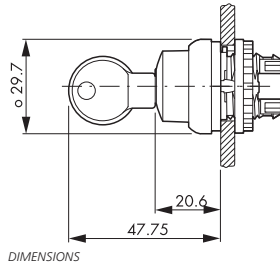

DIMENSIONS

■ SCHRACK INFO

- IP 66
- Locking system, 4 levels
- The following can be modified for MM 216406: spring-return/stay-put, key removable/not removable
- 22.5 mm diameter

DESCRIPTION	WxHxD (mm)	EAN CODE	AVAILABLE	ORDER NO.
2 positions, spring-return, 40°	dia. 29.7x20.6	9004840175820		MM216881
2 positions, stay-put, 60°	dia. 29.7x20.6	9004840175837		MM216887
3 positions, spring-return, 40°	dia. 29.7x20.6	9004840175844		MM216894
3 positions, stay-put, 60°	dia. 29.7x20.6	9004840175851		MM216900
Key MS1 Standard	dia. 29.7x20.6	9004840204117		MM216416

■ SERIES MM – ROTARY KNOB



MM216853

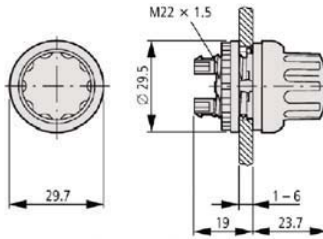

DIMENSIONS

■ SCHRACK INFO

- IP 67
- 22.5 mm diameter

DESCRIPTION	WxHxD (mm)	EAN CODE	AVAILABLE	ORDER NO.
2 positions, spring-return, "I/O"	dia. 29.7x23.7	9004840207835		MM216853
3 positions, spring-return "I/O/O"	dia. 29.7x23.7	9004840207866		MM216861

■ SERIES MM – JOYSTICK



MM289196

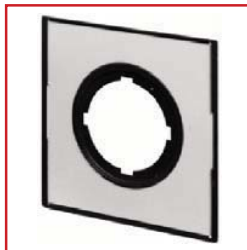

MM279436

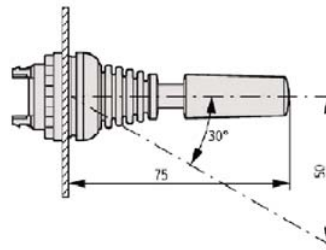

DIMENSIONS

DESCRIPTION	WxHxD (mm)	EAN CODE	AVAILABLE	ORDER NO.
2 positions, spring-return	dia. 30x75	9004840665079		MM289196
2 positions, stay-put	dia. 30x75	9004840665093		MM289240
4 positions, spring-return	dia. 30x75	9004840626582		MM279417

ACCESSORIES

Label holder + label for custom text	50x50	9004840665086		MM279436
--------------------------------------	-------	---------------	--	----------



MAIN SWITCHES, CONTROL SWITCHES, COMMAND AND SIGNALLING DEVICES

■ SERIES MM – INDICATOR LIGHT, FLAT



MM216771

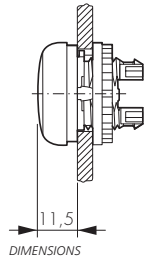

DIMENSIONS

■ SCHRACK INFO

- IP 67, 69K
- 22.5 mm diameter
- LED technology

DESCRIPTION	WxHxD (mm)	EAN CODE	AVAILABLE	ORDER NO.
Flat, white	dia. 29.7x11.5	9004840177398		MM216771
Flat, red	dia. 29.7x11.5	9004840177404		MM216772
Flat, green	dia. 29.7x11.5	9004840177411		MM216773
Flat, yellow	dia. 29.7x11.5	9004840177428		MM216774
Flat, blue	dia. 29.7x11.5	9004840177435		MM216775
Flat, empty	dia. 29.7x11.5	9004840177442		MM216776

■ SERIES MM – INDICATOR LIGHT, CONICAL



MM216779

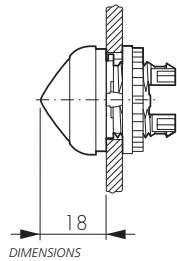

DIMENSIONS

■ SCHRACK INFO

- IP 67, 69K
- 22.5 mm diameter
- LED technology

DESCRIPTION	WxHxD (mm)	EAN CODE	AVAILABLE	ORDER NO.
High, white	dia. 29.7x18	9004840175868		MM216778
High, red	dia. 29.7x18	9004840175875		MM216779
High, green	dia. 29.7x18	9004840175882		MM216780
High, yellow	dia. 29.7x18	9004840175899		MM216781

■ SERIES MM – ACOUSTIC INDICATOR



MM229015



MM229015 WITH BUZZER

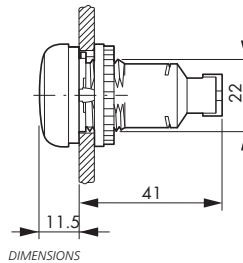

DIMENSIONS

■ SCHRACK INFO

- Volume: 83 dB
- IP 40
- 22.5 mm diameter

DESCRIPTION	WxHxD (mm)	EAN CODE	AVAILABLE	ORDER NO.
Acoustic indicator, empty	dia. 29.7x11.5	9004840207903		MM229015
Buzzer, continuous tone, 18-30 V AC/DC	dia. 29.7x11.5	9004840207781		MM229025
Buzzer, pulse tone 24 V DC	dia. 29.7x11.5	9004840207798		MM229028



Order no. blue: on stock, usually ready for delivery on the day of order!

Скачано с сайта интернет магазина <https://axiomplus.com.ua>



MAIN SWITCHES, CONTROL SWITCHES, COMMAND AND SIGNALLING DEVICES

■ SERIES MM – ILLUMINATED PUSHBUTTONS, FLAT



MM216938

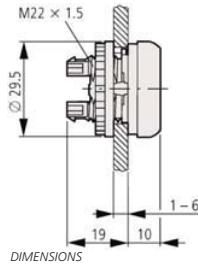

■ SCHRACK INFO

- IP 67, 69K
- 22.5 mm diameter
- Custom label is also possible on the button lens

DESCRIPTION	WxHxD (mm)	EAN CODE	AVAILABLE	ORDER NO.
SPRING-RETURN				
Flat, spring-return, white	dia. 29.7x10	9004840175929		MM216922
Flat, spring-return, red	dia. 29.7x10	9004840175936		MM216925
Flat, spring-return, green	dia. 29.7x10	9004840175943		MM216927
Flat, spring-return, yellow	dia. 29.7x10	9004840175950		MM216929
Flat, spring-return, blue	dia. 29.7x10	9004840175967		MM216931
Flat, spring-return, red "0"	dia. 29.7x10	9004840175981		MM216936
Flat, spring-return, green "1"	dia. 29.7x10	9004840175998		MM216938
Flat, spring-return, white "0"	dia. 29.7x10	9004840176001		MM216940
Flat, spring-return, white "1"	dia. 29.7x10	9004840176018		MM216942
Flat, spring-return, without button plate	dia. 29.7x10	9004840175974		MM216933
STAY-PUT				
Flat, stay-put, white	dia. 29.7x10	9004840176025		MM216944
Flat, stay-put, red	dia. 29.7x10	9004840176032		MM216946
Flat, stay-put, green	dia. 29.7x10	9004840176049		MM216948
Flat, stay-put, yellow	dia. 29.7x10	9004840176056		MM216950
Flat, stay-put, blue	dia. 29.7x10	9004840176063		MM216952
Flat, stay-put, red "0"	dia. 29.7x10	9004840176087		MM216957
Flat, stay-put, green "1"	dia. 29.7x10	9004840176094		MM216959
Flat, stay-put, without button plate	dia. 29.7x10	9004840176070		MM216954



MAIN SWITCHES, CONTROL SWITCHES, COMMAND AND SIGNALLING DEVICES

■ SERIES MM – ILLUMINATED PUSHBUTTON, HIGH



MM216975

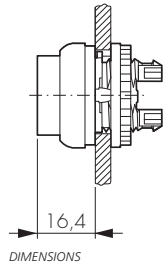

DIMENSIONS

■ SCHRACK INFO

- IP 67, 69K
- 22.5 mm diameter

DESCRIPTION	WxHxD (mm)	EAN CODE	AVAILABLE	ORDER NO.
SPRING-RETURN				
High, spring-return, white	dia. 29.7x16.4	9004840207521		MM216965
High, spring-return, red	dia. 29.7x16.4	9004840207538		MM216967
High, spring-return, green	dia. 29.7x16.4	9004840207545		MM216969
High, spring-return, yellow	dia. 29.7x16.4	9004840207552		MM216971
High, spring-return, blue	dia. 29.7x16.4	9004840207569		MM216973
High, spring-return, red "0"	dia. 29.7x16.4	9004840177459		MM216975

LENSES FOR ILLUMINATED PUSHBUTTONS

Button lens, illuminated buttons for red	dia. 22.5	9004840176872		MM216442
Button lens, illuminated buttons for green	dia. 22.5	9004840176889		MM216443
Button lens, illuminated buttons for yellow	dia. 22.5	9004840176896		MM216444
Button lens, illuminated buttons for blue	dia. 22.5	9004840176902		MM216445
Button lens, illuminated buttons for individual	dia. 22.5	9004840176919		MM216446

■ SERIES MM – SELECTOR SWITCHES



MM216865

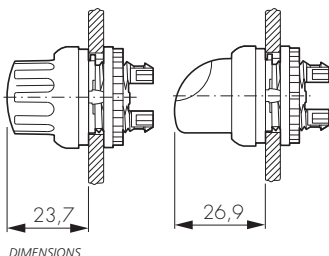

DIMENSIONS

■ SCHRACK INFO

- IP 66
- 22.5 mm diameter
- Stay-put: 60°
- Spring-return: 40°

■ TIPS & TRICKS

The coding parts MM 216407 can be used for conversion from stay-put to spring-return function!

DESCRIPTION	WxHxD (mm)	EAN CODE	AVAILABLE	ORDER NO.
2 POSITIONS				
2 positions, spring-return, 40°, thumb grip	dia. 29.7x26.9	9004840175752		MM216865
2 positions, stay-put, 60°, thumb grip	dia. 29.7x26.9	9004840175769		MM216867
2 positions, V-position, stay-put, thumb grip	dia. 29.7x26.9	9004840207897		MM216874
2 positions, stay-put, black, I-0, thumb grip	dia. 29.7x23.7	9004840196535		MM216855
3 POSITIONS				
3 positions, spring-return, 40°, thumb grip	dia. 29.7x26.9	9004840175776		MM216870
3 positions, stay-put, 60°, thumb grip	dia. 29.7x26.9	9004840175783		MM216872
3 positions, stay-put, black, I-0-II, rotary switch	dia. 29.7x23.7	9004840207873		MM216863



Order no. blue: on stock, usually ready for delivery on the day of order!

Скачано с сайта интернет магазина <https://axiomplus.com.ua>



MAIN SWITCHES, CONTROL SWITCHES, COMMAND AND SIGNALLING DEVICES

■ SERIES MM – ILLUMINATED SELECTOR SWITCHES, 2 POSITIONS



MM216845

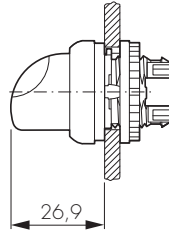

DIMENSIONS

■ SCHRACK INFO

- IP 66
- 22.5 mm diameter

DESCRIPTION	WxHxD (mm)	EAN CODE	AVAILABLE	ORDER NO.
SPRING-RETURN				
2 positions, spring-return, white	dia. 29.7x26.9	9004840176124		MM216812
2 positions, spring-return, red	dia. 29.7x26.9	9004840176131		MM216814
2 positions, spring-return, green	dia. 29.7x26.9	9004840176148		MM216816
2 positions, spring-return, yellow	dia. 29.7x26.9	9004840191486		MM216818
STAY-PUT				
2 positions, stay-put, white	dia. 29.7x26.9	9004840176155		MM216823
2 positions, stay-put, red	dia. 29.7x26.9	9004840176162		MM216825
2 positions, stay-put, green	dia. 29.7x26.9	9004840176179		MM216827
2 positions, stay-put, yellow	dia. 29.7x26.9	9004840191509		MM216829
2 positions, stay-put, blue	dia. 29.7x26.9	9004840191516		MM216831

■ SERIES MM – ILLUMINATED SELECTOR SWITCHES, 3 POSITIONS



MM216833

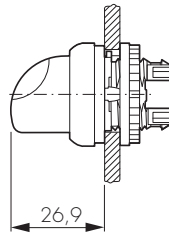

DIMENSIONS

■ SCHRACK INFO

- IP 66
- 22.5 mm diameter

DESCRIPTION	WxHxD (mm)	EAN CODE	AVAILABLE	ORDER NO.
SPRING-RETURN				
3 positions, spring-return, white	dia. 29.7x26.9	9004840176186		MM216833
3 positions, spring-return, red	dia. 29.7x26.9	9004840176193		MM216835
3 positions, spring-return, green	dia. 29.7x26.9	9004840176209		MM216837
STAY-PUT				
3 positions, stay-put, white	dia. 29.7x26.9	9004840176216		MM216843
3 positions, stay-put, red	dia. 29.7x26.9	9004840176223		MM216845
3 positions, stay-put, green	dia. 29.7x26.9	9004840176230		MM216847
3 positions, stay-put, yellow	dia. 29.7x26.9	9004840191547		MM216849
3 positions, stay-put, blue	dia. 29.7x26.9	9004840191554		MM216851

MAIN SWITCHES, CONTROL SWITCHES, COMMAND AND SIGNALLING DEVICES

SERIES MM – ADAPTERS



MM216374

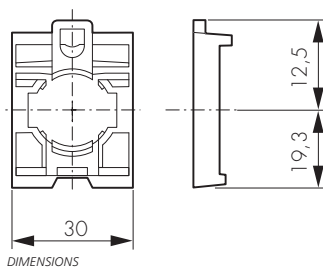

DIMENSIONS

SCHRACK INFO

- For front mounting of switch and LED elements

TIPS & TRICKS

The mounting adapter is required for any command and signal device that consists of individual components. Up to 6 contacts or one LED plus up to 4 contacts can be mounted.

DESCRIPTION	WxH (mm)	EAN CODE	AVAILABLE	ORDER NO.
Mounting adapter (front)	30x31.8	9004840176247		MM216374
Mounting adapter (front), 4 mounting locations	44x45	9004840467741		MM279437

SERIES MM – SWITCHING ELEMENTS



MM216378

SCHRACK INFO

- Spring-tension (CC=spring terminals) or screw terminals
- Breaking capacity: AC15, 230 V 6 A
DC13, 24 V 3 A

DESCRIPTION	EAN CODE	AVAILABLE	ORDER NO.
SWITCHING ELEMENT FOR FRONT MOUNTING			
NO contact front	9004840176254		MM216376
NC contact front	9004840176261		MM216378
NO contact CC front	9004840176292		MM216384
NC contact CC front	9004840176308		MM216385
SWITCHING ELEMENT FOR FLOOR MOUNTING			
NO contact, floor	9004840176278		MM216380
NC contact, floor	9004840176285		MM216382
NO contact CC, floor	9004840176315		MM216386
NC contact CC, floor	9004840176322		MM216387
SWITCHING ELEMENT WITH DOUBLE CONTACTS			
NC double contact CC front	9004840547054		MM107899
NO double contact CC front	9004840625783		MM107940



MAIN SWITCHES, CONTROL SWITCHES, COMMAND AND SIGNALLING DEVICES

■ SERIES MM – LIGHT EMITTING DIODES



MM216557

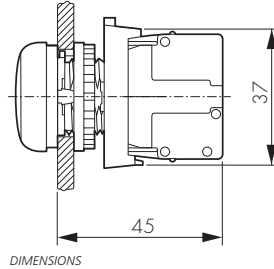

DIMENSIONS

■ SCHRACK INFO

2 supply voltages:	12-30 V AC/DC 85-264 V AC
Rated current:	12-30 V AC/DC: 8-15 mA 85-264 V AC: 5-15 mA (Pmax = 0.33 W)
Diameter:	22.5 mm

■ TIPS & TRICKS

Use for enclosures and telescopic clip floor. Spring terminals (CC).

DESCRIPTION	EAN CODE	AVAILABLE	ORDER NO.
LED FOR FRONT MOUNTING			
LED 12-30 V AC/DC white front	9004840176339		MM216557
LED 12-30 V AC/DC red front	9004840176346		MM216558
LED 12-30 V AC/DC green front	9004840176353		MM216559
LED 12-30 V AC/DC, blue front	9004840184549		MM218057
LED 12-30 V AC/DC white CC front	9004840176452		MM216569
LED 12-30 V AC/DC red CC front	9004840176469		MM216570
LED 12-30 V AC/DC green CC front	9004840176476		MM216571
LED 12-30 V AC/DC, blue CC front	9004840184525		MM218061
LED 85-264 V AC white front	9004840176391		MM216563
LED 85-264 V AC red front	9004840176407		MM216564
LED 85-264 V AC green front	9004840176414		MM216565
LED 85-264 V AC, blue front	9004840184556		MM218059
LED 85-264 V AC white CC front	9004840176513		MM216575
LED 85-264 V AC red CC front	9004840176520		MM216576
LED 85-264 V AC green CC front	9004840176537		MM216577
LED 85-264 V AC, blue CC front	9004840184501		MM218063
LED FOR FLOOR MOUNTING			
LED 12-30 V AC/DC white, floor	9004840176360		MM216560
LED 12-30 V AC/DC red, floor	9004840176377		MM216561
LED 12-30 V AC/DC green, floor	9004840176384		MM216562
LED 12-30 V AC/DC, blue, floor	9004840184563		MM218058
LED 12-30 V AC/DC white, floor CC	9004840176483		MM216572
LED 12-30 V AC/DC green, floor CC	9004840176506		MM216574
LED 12-30 V AC/DC red, floor CC	9004840176490		MM216573
LED 85-264 V AC white, floor	9004840176421		MM216566
LED 85-264 V AC red, floor	9004840176438		MM216567
LED 85-264 V AC green, floor	9004840176445		MM216568
LED 85-264 V AC blue, floor	9004840184570		MM218060
LED 85-264 V AC red, floor CC	9004840176551		MM216579
LED 85-264 V AC white, floor CC	9004840176544		MM216578
LED ACCESSORIES			
LED test module 12-30 V AC/DC	9004840246865		MM231079
LED test module 85-264 V AC/DC	9004840242317		MM231080



MAIN SWITCHES, CONTROL SWITCHES, COMMAND AND SIGNALLING DEVICES

SERIES MM – COMPLETE UNITS



MM216529



MM216525

SCHRACK INFO

- 22.5 mm diameter
- Surface mounting: Insulated enclosure IP 67
- Surface and panel mounting units delivered pre-assembled.

DESCRIPTION	EAN CODE	AVAILABLE	ORDER NO.
All-in-one surface buttons, 2x "0", "1"	9004840177251		MM216529
All-in-one surface buttons, 3x "1", "0", "2"	9004840177268		MM216532
All-in-one surface buttons, key switch, 1NO 1NC, Spring-return/stay-put function	9004840177244		MM216526
All-in-one surface buttons, emergency stop mushroom button 1NO 1NC	9004840177237		MM216525
All-in-one surface buttons, emergency stop mushroom button 2NC	9004840177220		MM216524
All-in-one surface buttons, emergency stop mushroom button 1NO 1NC	9004840177213		MM216523
All-in-one surface buttons, green "1"	9004840177206		MM216522
All-in-one surface buttons, red "0"	9004840177190		MM216521
All-in-one emergency stop button 1 NC for panel mounting	9004840195781		MM216515
All-in-one emergency stop button 1NO 1NC	9004840215311		MM216516
All-in-one emergency stop button 1NO 1NC, spring-return/stay-put function	9004840372144		MM216514

SERIES MM – POTENTIOMETERS



MM229491

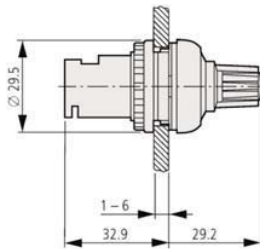

DIMENSIONS

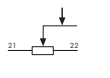

CIRCUIT DIAGRAM

SCHRACK INFO

- Complete with potentiometer
- From 1 k Ω to 470 k Ω
- 3 terminals lead out separately
- Degree of protection IP 65
- Fully insulated
- Pmax = 0.5 W

DESCRIPTION	WxHxD (mm)	EAN CODE	AVAILABLE	ORDER NO.
Potentiometer 1 k Ω	dia. 29.5x29.2	9004840207699		MM229489
Potentiometer 4.7 k Ω	dia. 29.5x29.2	9004840207705		MM229490
Potentiometer 10 k Ω	dia. 29.5x29.2	9004840207712		MM229491
Potentiometer 100 k Ω	dia. 29.5x29.2	9004840207736		MM229493
Potentiometer 470 k Ω	dia. 29.5x29.2	9004840207743		MM229494



I KNOW WHERE TO FIND IT!

WITH THE SCHRACK TECHNIK LIVE-PHONE APP

- Access technical product information at any time and from everywhere
- See availability and price immediately
- Order desired products easily



Order no. blue: on stock, usually ready for delivery on the day of order!

Скачано с сайта интернет магазина <https://axiomplus.com.ua>



MAIN SWITCHES, CONTROL SWITCHES, COMMAND AND SIGNALLING DEVICES

SERIES MM – SURFACE ENCLOSURE



MM216536



MM216538



MM222688

SCHRACK INFO

- 22.5 mm diameter

DIMENSIONS

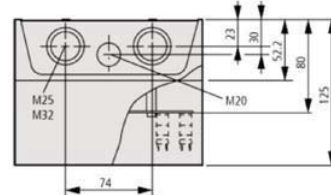
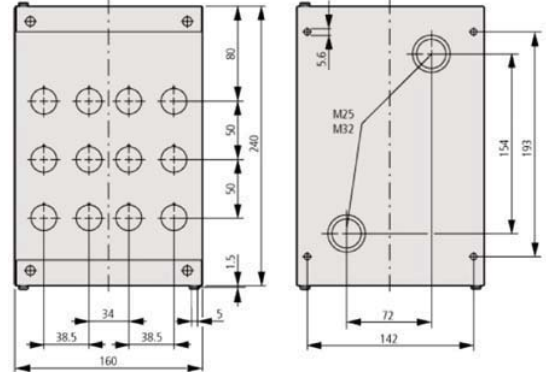
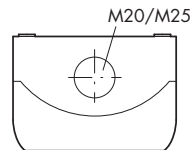
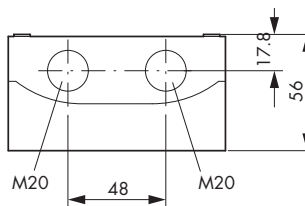
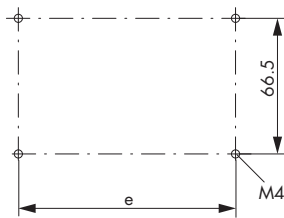
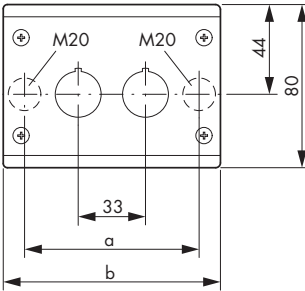

Installation positions	a	b	e	Line entries
1	172	42.6	58.5	2 x M16 3 x M20 2 x M25
2	120	85.6	106.5	2 x M20 3 x M20 2 x M25
3	153	118.6	139.5	2 x M20 2 x M25 4 x M20
4	186	151.6	172.5	2 x M20 2 x M25 4 x M40
6	252	217.6	238.5	2 x M20 2 x M25 4 x M20
12	72	160.0	193.0	2 x M20 2 x M32 4 x M32

DESCRIPTION	EAN CODE	AVAILABLE	ORDER NO.
Surface enclosure 1 black/light grey	9004840176575		MM216535
Surface enclosure 1 black/yellow	9004840176582		MM216536
Surface enclosure 2 black/light grey	9004840176599		MM216537
Surface enclosure 3 black/light grey	9004840176605		MM216538
Surface enclosure 4 black/light grey	9004840176612		MM216539
Surface enclosure 6 black/light grey	9004840176629		MM216540
Surface enclosure 12 black/light grey	9004840196528		MM222688



MAIN SWITCHES, CONTROL SWITCHES, COMMAND AND SIGNALLING DEVICES

LABELS FOR SERIES MM



MM216494



MM216465

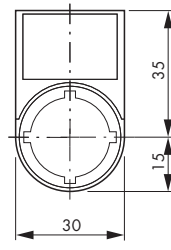

DIMENSIONS

DESCRIPTION	EAN CODE	AVAILABLE	ORDER NO.
Emergency stop label, dia.=60, 4 languages	9004840226768		MM216483
Emergency stop label 50x50	9004840215328		MM216484
Label holder, empty 30x50mm	9004840176643		MM216392
Label holder for double pushbutton, empty 30x75	9004840176650		MM216394
Emergency stop label, dia.=90, empty	9004840176940		MM216464
Emergency stop label, dia.=90, 4 languages	9004840176957		MM216465
Label, 18x27 mm, alu, plain	9004840176971		MM216480
Label, 18x27 mm, custom	9004840176988		MM216482
Label+holder 30x50 0 I	9004840177008		MM216485
Label+holder 30x50 1 0 II	9004840177022		MM216486
Label+holder 30x50 On	9004840177046		MM216487
Label+holder 30x50 Operation	9004840177053		MM216488
Label+holder 30x50 Alarm	9004840177060		MM216489
Label+holder 30x50 Off On	9004840177077		MM216490
Label+holder, Manual Auto	9004840177084		MM216492
Label+holder, Manual 0 Auto	9004840177091		MM216493
Label+holder 30x50 Stop	9004840177107		MM216494
Label+holder 30x50 Start	9004840177114		MM216495
Label+holder 30x50 ON	9004840177138		MM216496
Label+holder 30x50 OFF ON	9004840177169		MM216499
Label+holder, MAN. 0 AUTO	9004840177183		MM216501
Label+holder 30x50 Off	9004840177039		MM218299
Label+holder 30x50 OFF	9004840177121		MM218300
Emergency stop label 33x50	9004840190168		MM216472
Emergency stop label 33x50	9004840195767		MM216471



I KNOW WHERE TO FIND IT!

THE SCHRACK TECHNIK WEB SHOP WITH NAVIGATOR
WWW.SCHRACK.COM

- Finding product information made easy
- Buying products around the clock
- Quick access customer service



MAIN SWITCHES, CONTROL SWITCHES, COMMAND AND SIGNALLING DEVICES

OTHER ACCESSORIES FOR SERIES MM



MM216398



MM216400



MM231273

DIMENSIONS

Pushbuttons, illuminated pushbuttons, signal lamps with telescopic clip

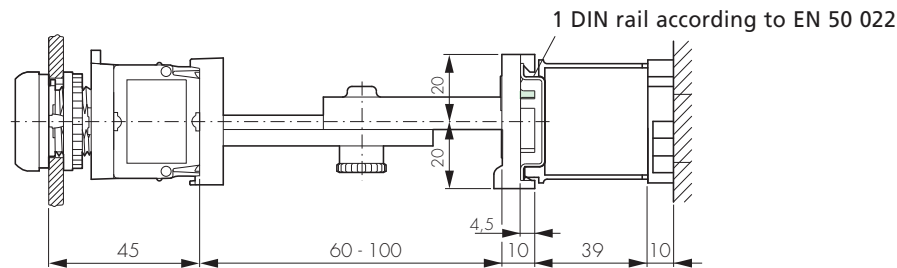

DIN rail adapter

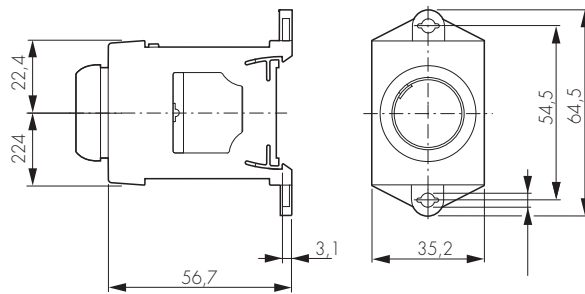

Protective collars for emergency stop

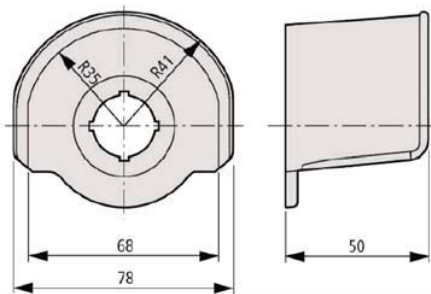

DESCRIPTION	EAN CODE	AVAILABLE	ORDER NO.
Telescopic clip	9004840177473		MM216398
DIN rail adapter	9004840176698		MM216400
Button protective membrane for pushbuttons	9004840176667		MM216395
Button protective membrane for double pushbuttons	9004840176674		MM216396
Sealing cover for emergency stop	9004840176681		MM216397
Protective collar for emergency stop, yellow	9004840276725		MM231273
Protective collar for emergency stop, grey	9004840456288		MM271610
Coding part pull-off	9004840176711		MM216406
Coding part stay-put/spring-return	9004840176728		MM216407
Bridge for centre contact	9004840207934		MM216405
Threaded ring M22x1.5 mm	9004840177466		MM216401
Mounting key	9004840176704		MM216402
Reducer kit from 30 to 22.3 mm drill hole	9004840190151		MM216408
Blind cap, black, round	9004840176636		MM216390
Blind cap, grey	9004840207910		MM216388



MAIN SWITCHES, CONTROL SWITCHES, COMMAND AND SIGNALLING DEVICES

■ SERIES MM – PALM SWITCHES

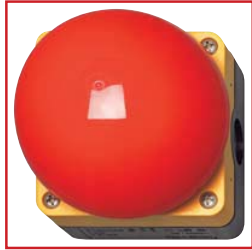

MM229747/IMM229748



MM229749



MM229746

■ SCHRACK INFO

- IP 67/ IP 69K
- NC with safety function through positive opening operation meeting IEC 947-5-1
- Large robust impact surface
- Emergency stop provides overload-proof operation in accordance with ISO 13 850/EN 418

■ TIPS & TRICKS

The auxiliary contacts are identical to those of the titanium range

■ DIMENSIONS

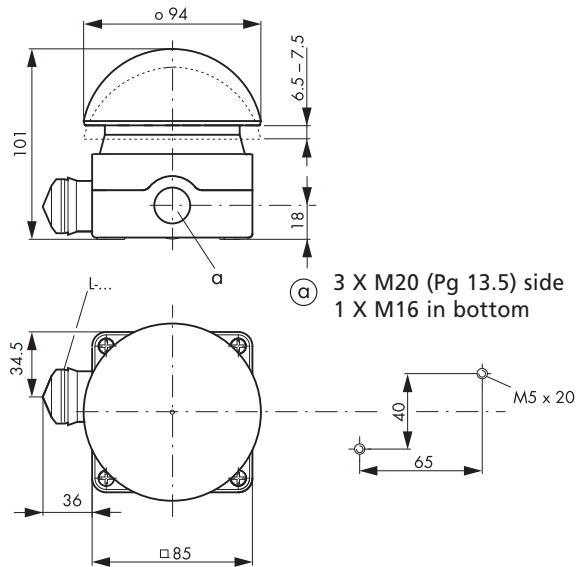

DESCRIPTION	EAN CODE	AVAILABLE	ORDER NO.
Palm switch, black, 1 NO/1 NC, momentary	9004840226324		MM229749
Palm switch, red, 1 NO/1 NC, momentary	9004840226355		MM229746
Emergency stop switch, 1 NC, maintained	9004840226331		MM229747
Emergency stop switch, 1 NO/1 NC, maintained	9004840226348		MM229748



MAIN SWITCHES, CONTROL SWITCHES, COMMAND AND SIGNALLING DEVICES

■ SERIES MM – SIGNAL LAMPS – GENERAL INFORMATION



SIGNAL LAMPS RMQ TITANIUM

■ SCHRACK INFO

The signal lamps are ideal, for example, to indicate different operating states of machinery.

■ TIPS & TRICKS

The free programmability of each module allows you set up different alert levels – both visual and audible indicators. Programming simply by jumpers.

■ TECHNICAL DATA

- Degree of protection IP 54 (acoustic indicator IP 20)
- Modular design without wire
- Individual modules can be programmed separately
- Easy mounting through bayonet clock
- Up to 5 modules can be controlled
- For 110 - 130 V and 230 V AC or 24 V DC
- Continuous and blinking light, with 5 W incandescent lamp, BA 15d
- Flashing light, with 15 cd light intensity, Flashing frequency approx. 60/min
- Acoustic indicator with 90 dB
- Terminal capacity 6 x 1.5 mm²
- Five dome colours: red, yellow, green, blue, white
- Meets the standards and specifications: IEC/EN 60 947, VDE 0660
- Degree of protection: IP54
- Climatic proofing:
 - Damp heat, constant: IEC 60 068-2-3
 - cyclic: IEC 60 068-2-30
- Ambient temperature closed, min./max.: -25/+50 °C
- Installation in any position
- Shock resistance (shock duration 11 ms) in accordance with IEC 60 068-2-27: 15 g
- Terminal capacity
 - solid: 2x1.5; 1x2.5 mm²
 - stranded: 2x0.5; 1x1.5 mm²
- Current paths
 - Rated surge voltage protection Uimp: 4000 V
 - Rated insulation voltage Ui: 250 V
 - Overvoltage category/pollution degree: III/3

■ SERIES MM – SIGNAL LAMPS – SYSTEM OVERVIEW

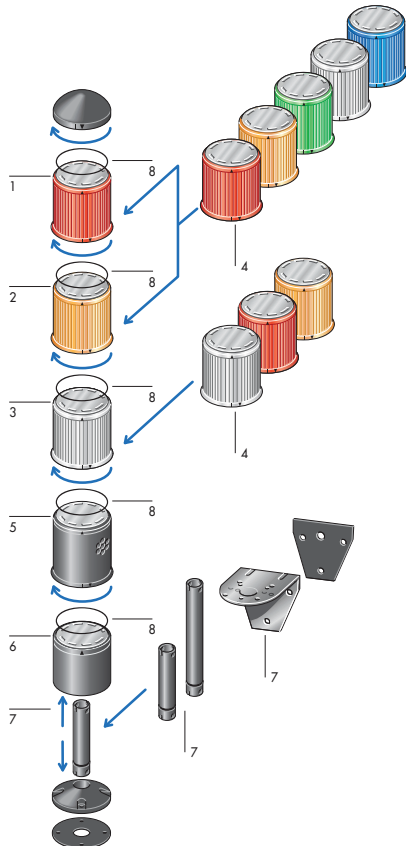

- 1 Permanent light
- 2 Flashing light
- 3 Strobe like
- 4 Domes
- 5 Audible alarms
- 6 Base module
- 7 Optional equipment (mounting)
- 8 Gaskets

MAIN SWITCHES, CONTROL SWITCHES, COMMAND AND SIGNALLING DEVICES

■ SERIES MM – SIGNAL LAMPS – DIMENSIONS

Complete units

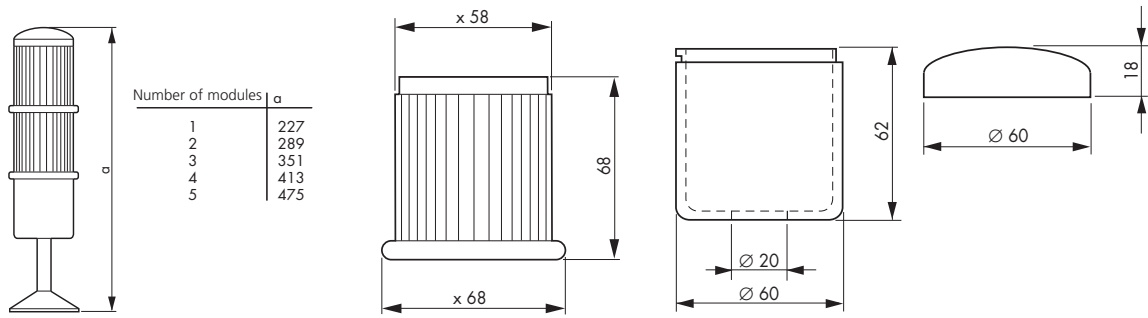

Mounting bracket MM205347

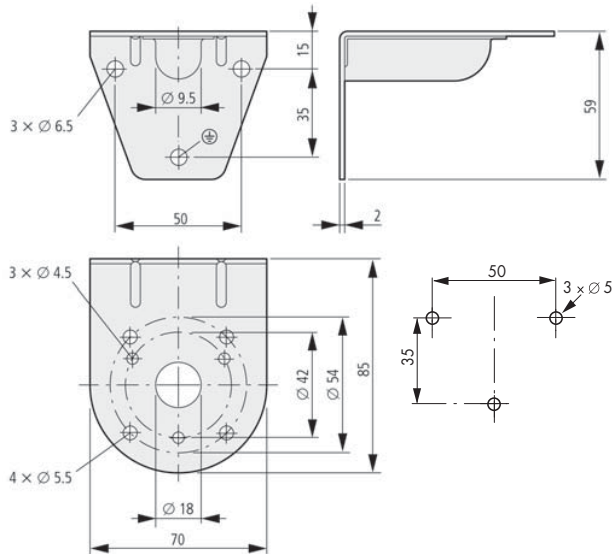

Foot MM205345 / MM215275
with tube

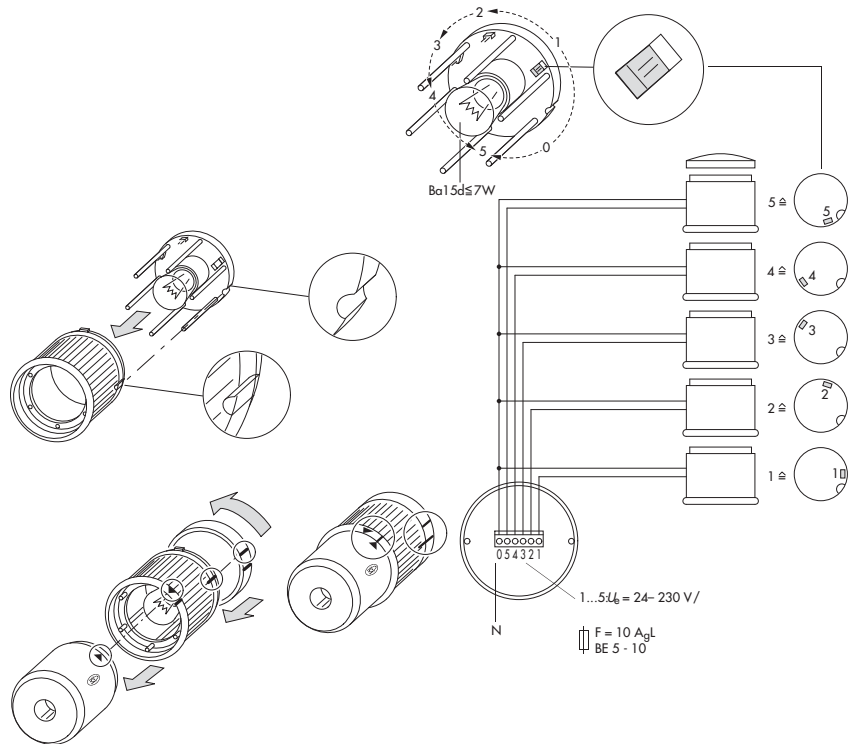
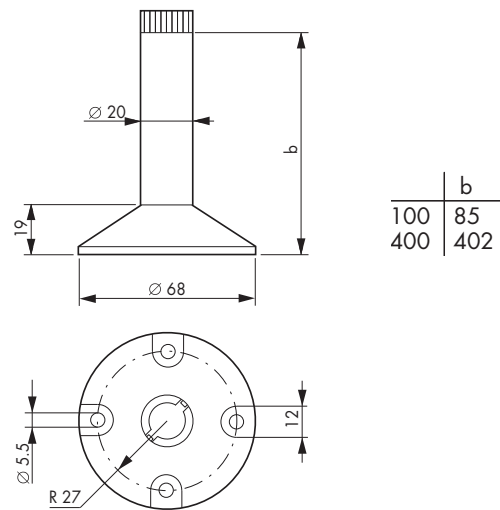

MAIN SWITCHES, CONTROL SWITCHES, COMMAND AND SIGNALLING DEVICES

■ SERIES MM – SIGNAL LAMPS – BASIC MODULE



MM205311

■ SCHRACK INFO

Terminal base plus end cover
The foot must be ordered separately!

DESCRIPTION	EAN CODE	AVAILABLE	ORDER NO.
Signal lamps, basic module with screw terminals	9004840204032		MM205311

■ SERIES MM – SIGNAL LAMPS – INDIVIDUAL MODULES



MM205313



MM205314





MM205315

DESCRIPTION	EAN CODE	AVAILABLE	ORDER NO.
Signal lamp, continuous light, white	9004840204049		MM205312
Signal lamp, continuous light, red	9004840204056		MM205313
Signal lamp, continuous light, green	9004840204148		MM205314
Signal lamp, continuous light, yellow	9004840204155		MM205315
Signal lamp, continuous light, blue	9004840204162		MM205316
Signal lamp, blinking light, red, 24 V DC	9004840204186		MM205318
Signal lamp, blinking light, red, 230 V AC	9004840204285		MM205328
Signal lamp, blinking light, green, 24 V DC	9004840204193		MM205319
Signal lamp, blinking light, green, 230 V AC	9004840204292		MM205329
Signal lamp, blinking light, yellow, 24 V DC	9004840204209		MM205320
Signal lamp, blinking light, yellow, 230 V AC	9004840204308		MM205330
Signal lamp, blinking light, blue, 230 V AC	9004840204315		MM205331
Signal lamp, flashing light, white, 24 V DC	9004840204322		MM205332
Signal lamp, flashing light, white, 230 V AC	9004840204384		MM205338
Signal lamp, flashing light, red, 24 V DC	9004840204339		MM205333
Signal lamp, flashing light, red, 230 V AC	9004840204391		MM205339
Signal lamp, flashing light, yellow, 24 V DC	9004840204346		MM205334
Signal lamp, flashing light, yellow, 230 V AC	9004840204407		MM205340
Acoustic module with continuous tone, 12-36 V AC/DC	9004840204414		MM205341
Acoustic module with continuous tone, 110-230 V AC/DC	9004840204421		MM205342
Acoustic module with pulse tone, 12-36 V AC/DC	9004840204438		MM205343
Acoustic module with pulse-tone, 110-230 V AC/DC	9004840204445		MM205344







MAIN SWITCHES, CONTROL SWITCHES, COMMAND AND SIGNALLING DEVICES

MAIN SWITCHES, CONTROL SWITCHES, COMMAND AND SIGNALLING DEVICES

■ SERIES MM – SIGNAL LAMPS – MOUNTING MATERIAL

DESCRIPTION	EAN CODE	AVAILABLE	ORDER NO.
Standfoot with tube 100 mm, plastic	9004840204452		MM205345
Standfoot with tube 400 mm, metal	9004840204674		MM215275
Mounting bracket	9004840204476		MM205347
Sealing kit to IP 65	9004840204698		MM215277

■ SERIES MM – SIGNAL LAMPS – ACCESSORIES

DESCRIPTION	EAN CODE	AVAILABLE	ORDER NO.
LED white 18-30 V AC/DC	9004840204704		MM215278
LED red 18-30 V AC/DC	9004840204711		MM215279
LED green 18-30 V AC/DC	9004840204728		MM215280
LED yellow 18-30 V AC/DC	9004840204735		MM215281
LED blue 18-30 V AC/DC	9004840204742		MM215282
Incandescent lamp 24 V	9004840204483		MM205348
Incandescent lamp 110-130 V	9004840204490		MM205349
Incandescent lamp 220-260 V	9004840204506		MM205350

