

ABB solar inverters

Product Manual

UNO-2.0/3.0/3.6/4.2-TL-OUTD

(from 2.0 to 4.2 kW)



Power and productivity
for a better world™





IMPORTANT SAFETY INSTRUCTIONS

This manual contains important safety instructions that must be followed during the installation and maintenance of the equipment.



Operators are required to read this manual and scrupulously follow the instructions given in it, since ABB cannot be held responsible for damage caused to people and/or things, or the equipment, if the conditions described below are not observed.

Product Manual

UNO-2.0/3.0/3.6/4.2-TL-OUTD string inverters

1 - Introduction and general information



2 - Characteristics



3 - Safety and accident prevention



4 - Lifting and transport



5 - Installation



6 - Instruments



7 - Operation



8 - Maintenance



Warranty and supply conditions

The warranty conditions are considered to be valid if the Customer adheres to the indications in this manual; any conditions deviating from those described herein must be expressly agreed in the purchase order.

ABB declares that the equipment complies with the provisions of law currently in force in the country of installation and has issued the corresponding declaration of conformity.

Not included in the supply

ABB accepts no liability for failure to comply with the instructions for correct installation and will not be held responsible for systems upstream or downstream of the equipment it has supplied.



It is absolutely forbidden to modify the equipment. Any modification, manipulation, or alteration not expressly agreed with the manufacturer, concerning either hardware or software, shall result in the immediate cancellation of the warranty.

The Customer is fully liable for any modifications made to the system.

Given the countless array of system configurations and installation environments possible, it is essential to check the following: adequate spaces, suitable for housing the equipment; airborne noise produced based on the environment; possible flammability conditions.

ABB will NOT be held liable for defects or malfunctions arising from: improper use of the equipment; deterioration resulting from transportation or particular environmental conditions; performing maintenance incorrectly or not at all; tampering or unsafe repairs; use or installation by unqualified persons.

ABB CANNOT be held responsible for disposal of: displays, cables, batteries, accumulators etc. The Customer shall therefore arrange for the disposal of substances potentially harmful to the environment in accordance with the legislation in force in the country of installation.

Table of Contents

Introduction and general information	4
Warranty and supply conditions	4
Not included in the supply.....	4
Table of Contents	5
Reference number index	8
Graphical representation of references	8
The document and intended audience	10
Purpose and structure of the document	10
List of annexes	10
Staff characteristics.....	10
Symbols and signs	11
Field of use, general conditions	13
Intended or allowed use.....	13
Limits in field of use.....	13
Improper or prohibited use	13
Characteristics	14
General conditions	14
Models and range of equipment	15
Identification of the equipment and manufacturer	16
Characteristics and technical data	18
Tightening torques	22
Overall dimensions	22
Bracket dimensions.....	23
Efficiency curves	24
Power limitation (Power Derating)	26
Power reduction due to environmental conditions.....	26
Power reduction due to the input voltage	27
Characteristics of a photovoltaic generator	28
Strings and Arrays.....	28
Description of the equipment	29
Operating diagram	29
Mutual connection of multiple inverters	30
Notes on the system sizing.....	30
Functionality and components of the equipment	31
Topographic diagram of the equipment UNO-2.0/3.0-TL-OUTD	33
Topographic diagram of the equipment UNO-3.6/4.2-TL-OUTD	35
Safety devices	37
Anti-Islanding	37
Ground fault of the photovoltaic panels	37
Other safety devices	37
Safety and accident prevention	38
Safety instructions and general information	38
Hazardous areas and operations	39
Environmental conditions and risks	39
Signs and labels.....	39
Thermal and electrical hazard	40
Clothing and protection of personnel.....	40



Residual risks	41
Table: residual risks.....	41
Lifting and transport.....	42
General conditions	42
Transport and handling	42
Lifting.....	42
Unpacking and checking	42
List of components supplied	43
Weight of the modules of the equipment.....	44
Installation	45
General conditions	45
Environmental checks.....	46
Installations above 2000 metres	46
Installation position.....	47
Wall mounting.....	48
preliminary operations for connection of the PV generator.....	49
Checking the correct polarity of the strings	49
Checking of leakage to ground of the photovoltaic generator.....	49
Selection of differential protection downstream of the inverter	50
Input connection to PV generator (DC side)	51
Installation procedure for quick-fit connectors	52
Distribution grid output connection (AC side).....	56
Characteristics and sizing of the line cable	56
Load protection switch (AC disconnect switch)	57
Installation of the cable on the AC output connector	57
Connection for the AC output connector to the inverter	59
Installation of the external protective grounding cable	60
Connection of the RS485 communication signals	61
Preparation of the RS485 cable.....	61
RS485 cable installation:	62
Connection of the RS485 line to a monitoring system	63
Connection of the control signals	65
Remote control connection	66
Connection enabling Stand-alone output	66
Configurable Relay connection (ALARM).....	67
Connector for the installation of expansion boards (optional).....	68
Closing the front cover	69
Instruments.....	70
General conditions	70
Description of keyboard and LED Panel.....	71
Operation.....	72
General conditions	72
Monitoring and data transmission	73
User interface mode.....	73
Types of data available	73
Measurement tolerance	73
Commissioning.....	74
Firmware update	76



Display access and settings	77
LED behaviour	78
Specifications on operation of the LEDs.....	79
LED insulation fault	79
Description of the menus	80
General information	80
Menu structure	81
System Menu	82
Inverter Menu	85
Display Menu	98
WIFI Logger Menu	100
AUTOTEST procedure in accordance with standard CEI 0-21.....	102
Running the tests from the display menu	102
Maintenance.....	104
General conditions	104
Routine maintenance	105
Troubleshooting	105
Alarm Messages	105
Power limitation messages	115
Registration on “Registration” website and calculation of second-level password (Service Menu)	117
Resetting the remaining time for grid standard variation	120
Verification of ground leakage	121
Behaviour of a system without leakage	121
Behaviour of a system with leakage	122
Measuring the insulation resistance of the PV generator.	123
Storage and dismantling	124
Storage of the equipment or prolonged stoppage	124
Dismantling, decommissioning and disposal.....	124
Further information	125
Contact us	126



Reference number index

- | | | |
|-----------------------------|------------------------------------|--|
| 01, Bracket | 08, Keyboard | 15, RS485 termination line jumper |
| 02, Locking screws | 09, DC input connectors | 16, DC disconnect switch |
| 03, Heat sink | 10, AC output connector | 17, Fastening points for Stand Alone board |
| 04, Anti-condensation valve | 11, Expansion board connector (J6) | 18, Stand-alone board (optional) |
| 05, Front cover | 12, SD Card slot | 19, External earth connection |
| 06, LED panel | 13, Signals terminal block | 20, Service cable glands |
| 07, Display | 14, RS485 connector | |

Graphical representation of references

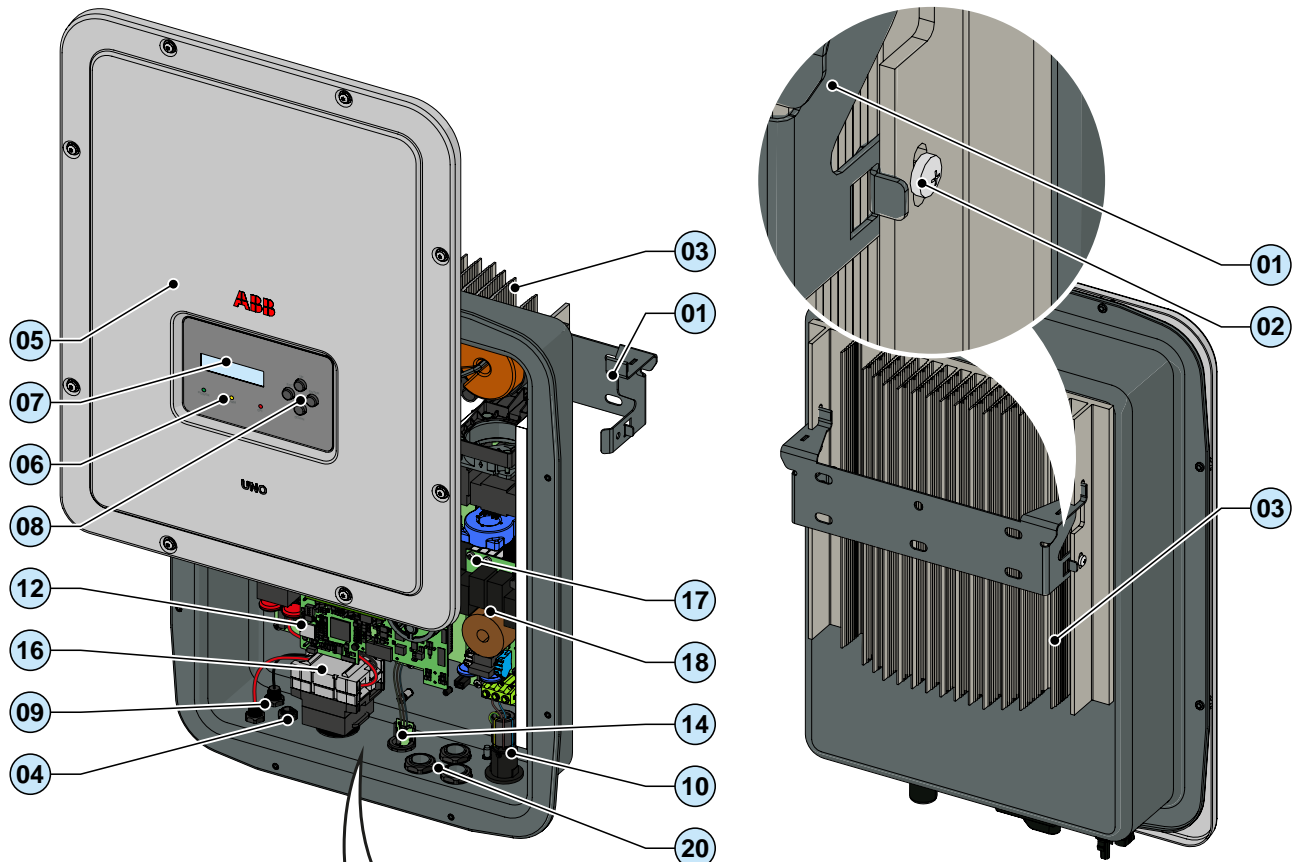

UNO-2.0/3.0/3.6/4.2-TL-OUTD

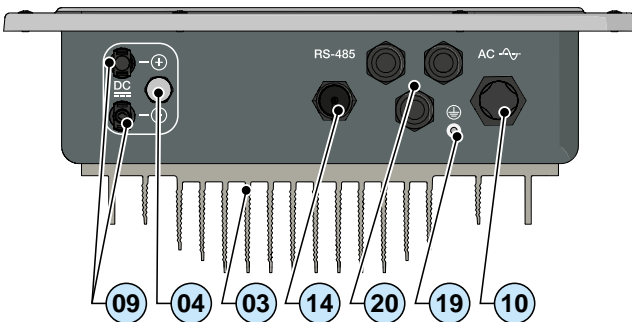

UNO-2.0/3.0/3.6/4.2-TL-OUTD-S

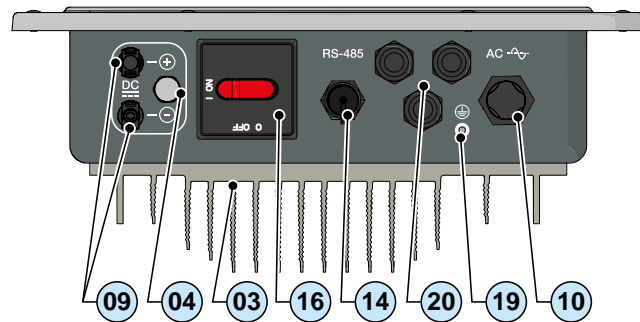



UNO-2.0/3.0-TL-OUTD-S

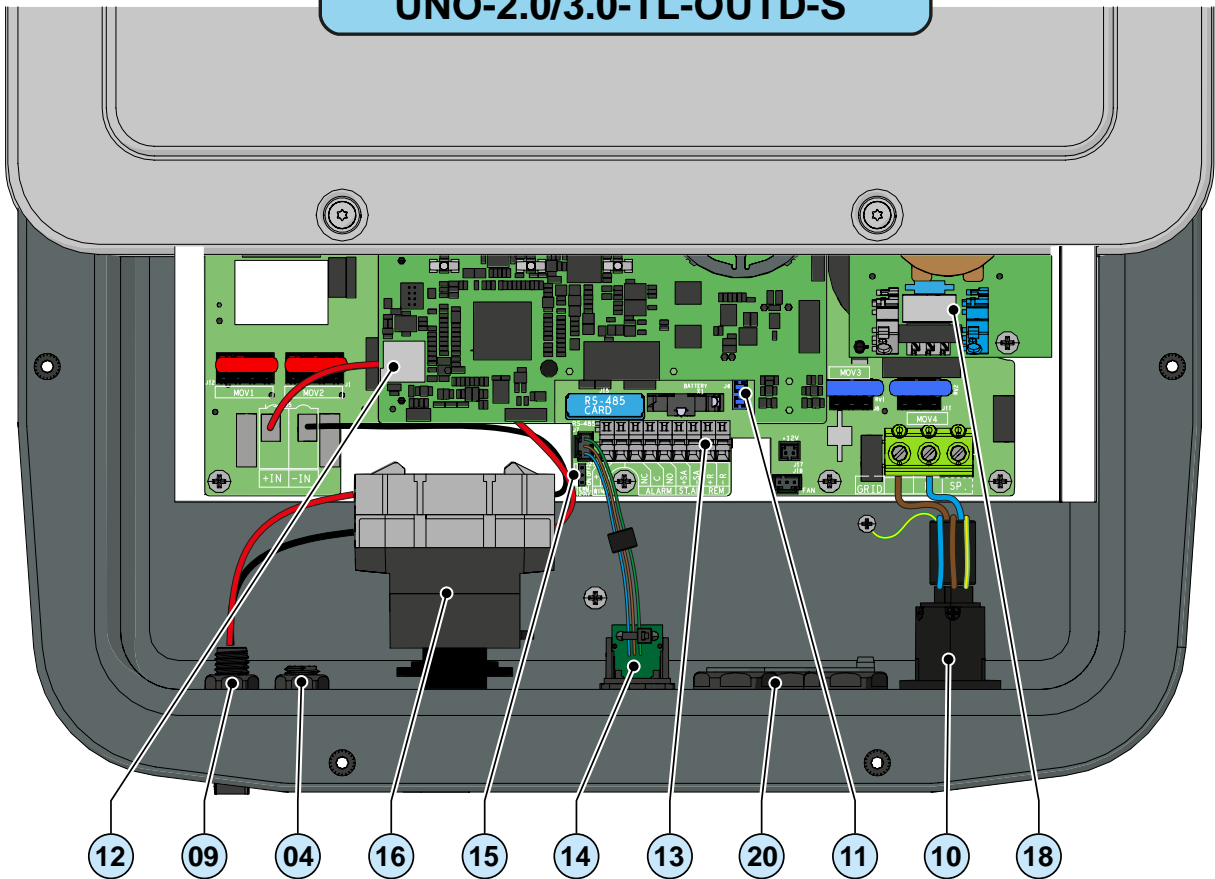

UNO-3.6/4.2-TL-OUTD-S

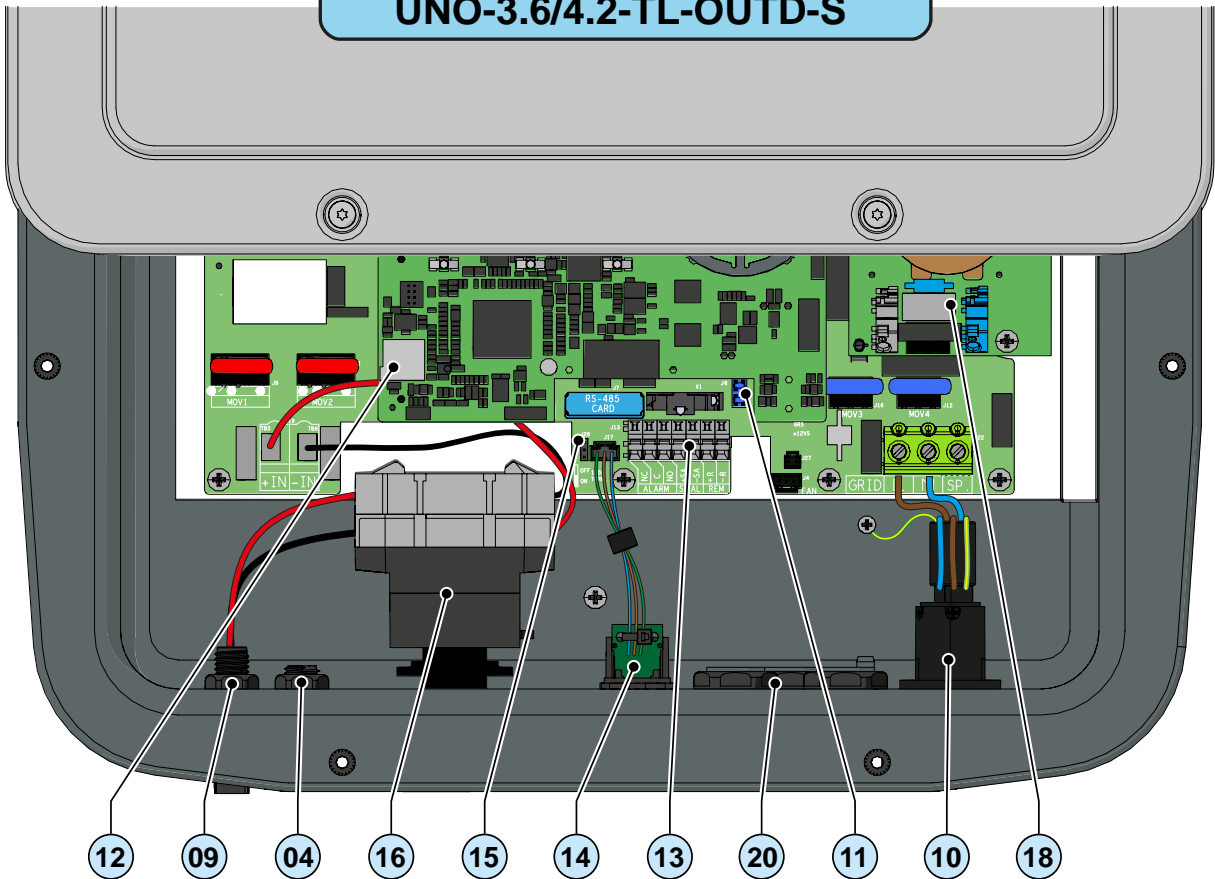

000467AG

The document and intended audience

Purpose and structure of the document

This operating and maintenance manual is a useful guide that will enable you to work safely and carry out the operations necessary for keeping the equipment in good working order.



If the equipment is used in a manner not specified in the installer manual, the protection provided by the equipment may be impaired.



The language in which the document was originally written is ITALIAN; therefore, in the event of inconsistencies or doubts please ask the manufacturer for the original document.

List of annexes

In addition to this operating and maintenance manual, (if applicable or on request) the following enclosed documentation is supplied:

- EC declaration of conformity
- quick installation guide



CAUTION: Part of the information given in this document is taken from the original documents provided by the suppliers. This document contains only the information considered necessary for the use and routine maintenance of the equipment.

Staff characteristics



The Customer must make sure that the operator has the necessary skills and training to do his/her job. The staff in charge of using and maintaining the equipment must be experienced, aware and responsible enough to perform the tasks described and must reliably demonstrate their ability to interpret what is described in the manual correctly.



For safety reasons, only a qualified electrician who has received training and/or demonstrated skills and knowledge on the structure and operation of the unit may install the inverter.



The installation must be performed by qualified installers and/or licensed electricians in accordance with the existing regulations in the country of installation.















The employment of a person who is NOT qualified, is drunk, or on narcotics, has a prosthetic mitral valve or a pacemaker is strictly forbidden.













The customer has civil liability for the qualification and mental or physical state of the professional figures who interact with the equipment. They must always use the personal protective equipment provided for by the laws of the country of destination and whatever else is provided by their employer.

Symbols and signs

In the manual and/or in some cases on the equipment, the danger or hazard zones are indicated with signs, labels, symbols or icons.

Symbol	Description
	Indicates that it is mandatory to consult the manual or original document, which must be available for future use and must not be damaged in any way.
	General warning - Important safety information. Indicates operations or situations in which staff must be very careful.
	Dangerous Voltage - Indicates operations or situations in which staff must be very careful with regard to dangerous voltage levels.
	Hot parts - Indicates a risk arising from the presence of hot zones or zones with parts at high temperatures (risk of burns).
	Risk of explosion
	Risk of injury due to the weight of the equipment. Take care during lifting and transport
	Indicates that the area in question must not be accessed or that the operation described must not be carried out.
	Keep out of the reach of children
	Indicates that smoking and the use of naked flames is prohibited.
	Indicates that it is mandatory to carry out the described operations using the clothing and/or personal protective equipment provided by the employer.
	WEEE logo. Indicates that the product is to be disposed of according to current legislation regarding the disposal of electronic components.
	Indicates the protection rating of the equipment according to IEC 70-1 (EN 60529 June 1997) standard.
	Point of connection for grounding protection.
	Indicates the permitted temperature range



Symbol	Description
	Indicates a risk of electric shock. Stored energy discharge time: 5 minutes
	Indicates a risk of electric shock. Stored energy discharge time: 10 minutes
	Direct Current
	Alternating current
	With insulation transformer
	Without insulation transformer
	Positive pole of the input voltage (DC)
	Negative pole of the input voltage (DC)
	Indicates the centre of gravity of the equipment.
	Indicates the requirement to wear acoustic protection devices in order to prevent damage to hearing



Field of use, general conditions

ABB accepts no liability for damage of any kind that may arise from incorrect or careless operations.



*You may not use the equipment for a use that does not conform to that provided for in the field of use. The equipment **MUST NOT** be used by inexperienced staff, or even experienced staff if carrying out operations on the equipment that fail to comply with the indications in this manual and enclosed documentation.*



Intended or allowed use

This equipment is a string inverter designed to:
 transform a direct current (DC)
 supplied by a photovoltaic generator (PV)
 in an alternating electrical current (AC)
 suitable for feeding into the public distribution network.

Limits in field of use

The inverter can be used only with photovoltaic modules which have ground isolated input poles, unless they are accessories installed that enable grounding of the inputs. In this case you must install an insulating transformer on the AC side of the system.

Only a photovoltaic generator can be connected in the input of the inverter (do not connect batteries or other sources of power supply).

The inverter can be connected to the electricity grid only in countries for which it has been certified/approved.

The inverter cannot be connected to the DC side in parallel to other inverters to convert energy from a photovoltaic generator with a power greater than the nominal power of the single inverter.

The inverter may only be used in compliance with all its technical characteristics.

Improper or prohibited use



IT IS STRICTLY FORBIDDEN TO:

- *Install the equipment in environments with particular flammability conditions or in adverse or disallowed environmental conditions (temperature and humidity).*
- *Use the equipment with safety devices which are faulty or disabled.*
- *Use the equipment or parts of the equipment by linking it to other machines or equipment, unless expressly provided for.*
- *Modify operating parameters that are not accessible to the operator and/or parts of the equipment to vary its performance or change its insulation.*
- *Clean the equipment with corrosive products that may corrode parts or generate electrostatic charges.*
- *Use or install the appliance or parts of it without having read and understood the contents of the user and maintenance manual.*
- *Warm or dry rags and clothes on parts at temperature. In addition to being hazardous, doing so would compromise component ventilation and cooling.*



General conditions

The characteristics of the equipment are described so that its main components can be identified and the technical terminology used in the manual can be explained.

Technical terminology and the fast information retrieval system, are supported by:

- Table of contents
- Reference number index

The Characteristics chapter contains information about the models, details of the equipment, characteristics and technical data, overall dimensions and identification of the equipment itself.



The customer/Installer takes full responsibility if, when reading this manual, the chronological order of its presentation established by the manufacturer is not observed. All information is provided and occasional reference may be made to information in previous chapters.



In certain cases, there may be a need to separately document software functionality or attach supplementary documentation to this manual intended for more qualified professional figures.

Models and range of equipment

The models of single-phase inverters covered by this manual are divided into four groups according to their maximum output power:

2.0kW, 3.0 kW, 3.6 kW or 4.2 kW.

For inverters of equal output power the variant between the various models is the presence or lack thereof of the DC disconnect switch ¹⁶



The choice of the inverter model must be made by a qualified technician who knows about the installation conditions, the devices that will be installed outside the inverter and possible integration with an existing system.



• UNO-2.0/3.0/3.6/4.2-TL-OUTD MODELS

- Number of input channels: 1
- DC disconnect switch ¹⁶: No
- Input connectors: quick-fit connectors (1 pair)

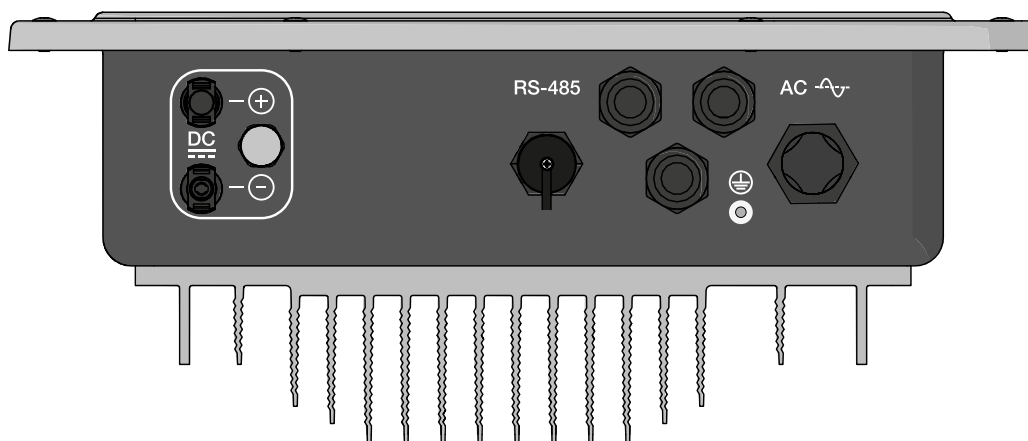

• UNO-2.0/3.0/3.6/4.2-TL-OUTD-S MODELS

- Number of input channels: 1
- DC disconnect switch ¹⁶: Yes
- Input connectors: quick-fit connectors (1 pair)

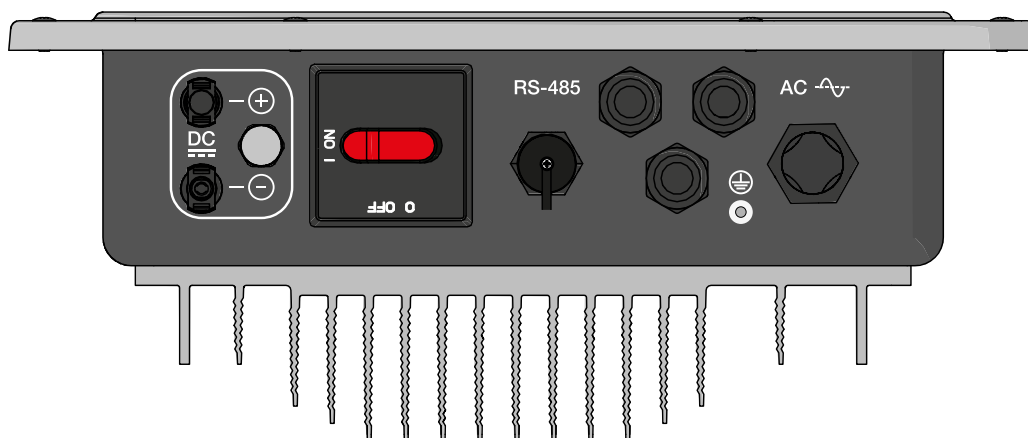

Identification of the equipment and manufacturer

The technical data provided in this manual does not substitute the data supplied on the labels affixed to the equipment.



The labels affixed to the equipment must NOT be removed, damaged, stained, hidden, etc., for any reason whatsoever.

The approval label contains the following information:

1. Manufacturer
2. Model
3. Rating data
4. Certification marks



The labels are NOT to be hidden by foreign objects and parts (rags, boxes, equipment, etc.); they must be regularly cleaned and always kept in sight.

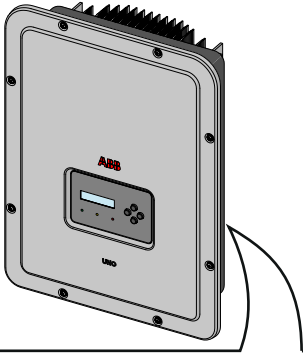

1	ABB	 <small>DIN V VDE V 0126-1-1</small> <small>PROTECTIVE CLASS:</small>	 <small>Made in Italy</small>																																				
3	www.abb.com/solar SOLAR INVERTER	2	MODEL: UNO-2.0-TL-OUTD																																				
<table border="1"> <tr> <td>V_{dc} max</td> <td>600 V</td> <td>V_{acr}</td> <td>230 V 1Ø</td> </tr> <tr> <td>V_{dc} MPP</td> <td>80 - 580 V</td> <td>f_r</td> <td>50 Hz</td> </tr> <tr> <td>V_{dc}, Full Power</td> <td>180 - 500 V</td> <td>S_{max}</td> <td>2000 VA</td> </tr> <tr> <td>I_{dc} max</td> <td>12.5 A</td> <td>P_{acr} (cosφ= 1)</td> <td>2000 W @ 45 °C amb.</td> </tr> <tr> <td>I_{sc} max</td> <td>16 A</td> <td>P_{acr} (cosφ= ± 0.9)</td> <td>1800 W @ 45 °C amb.</td> </tr> <tr> <td></td> <td></td> <td>I_{ac} max</td> <td>10 A</td> </tr> </table>		V_{dc} max	600 V	V_{acr}	230 V 1Ø	V_{dc} MPP	80 - 580 V	f_r	50 Hz	V_{dc}, Full Power	180 - 500 V	S_{max}	2000 VA	I_{dc} max	12.5 A	P_{acr} (cosφ= 1)	2000 W @ 45 °C amb.	I_{sc} max	16 A	P_{acr} (cosφ= ± 0.9)	1800 W @ 45 °C amb.			I_{ac} max	10 A	<table border="1"> <tr> <td>V_{acr}</td> <td>230 V 1Ø</td> </tr> <tr> <td>f_r</td> <td>50 Hz</td> </tr> <tr> <td>S_{max}</td> <td>2000 VA</td> </tr> <tr> <td>P_{acr} (cosφ= 1)</td> <td>2000 W @ 45 °C amb.</td> </tr> <tr> <td>P_{acr} (cosφ= ± 0.9)</td> <td>1800 W @ 45 °C amb.</td> </tr> <tr> <td>I_{ac} max</td> <td>10 A</td> </tr> </table>		V_{acr}	230 V 1Ø	f_r	50 Hz	S_{max}	2000 VA	P_{acr} (cosφ= 1)	2000 W @ 45 °C amb.	P_{acr} (cosφ= ± 0.9)	1800 W @ 45 °C amb.	I_{ac} max	10 A
V_{dc} max	600 V	V_{acr}	230 V 1Ø																																				
V_{dc} MPP	80 - 580 V	f_r	50 Hz																																				
V_{dc}, Full Power	180 - 500 V	S_{max}	2000 VA																																				
I_{dc} max	12.5 A	P_{acr} (cosφ= 1)	2000 W @ 45 °C amb.																																				
I_{sc} max	16 A	P_{acr} (cosφ= ± 0.9)	1800 W @ 45 °C amb.																																				
		I_{ac} max	10 A																																				
V_{acr}	230 V 1Ø																																						
f_r	50 Hz																																						
S_{max}	2000 VA																																						
P_{acr} (cosφ= 1)	2000 W @ 45 °C amb.																																						
P_{acr} (cosφ= ± 0.9)	1800 W @ 45 °C amb.																																						
I_{ac} max	10 A																																						
 -25 to + 60 °C -13 to +140 °F																																							





1	ABB	 <small>DIN V VDE V 0126-1-1</small> <small>PROTECTIVE CLASS:</small>	 <small>Made in Italy</small>																																				
3	www.abb.com/solar SOLAR INVERTER	2	MODEL: UNO-3.0-TL-OUTD																																				
<table border="1"> <tr> <td>V_{dc} max</td> <td>600 V</td> <td>V_{acr}</td> <td>230 V 1Ø</td> </tr> <tr> <td>V_{dc} MPP</td> <td>80 - 580 V</td> <td>f_r</td> <td>50 Hz</td> </tr> <tr> <td>V_{dc}, Full Power</td> <td>200 - 500 V</td> <td>S_{max}</td> <td>3000 VA</td> </tr> <tr> <td>I_{dc} max</td> <td>16 A</td> <td>P_{acr} (cosφ= 1)</td> <td>3000 W @ 45 °C amb.</td> </tr> <tr> <td>I_{sc} max</td> <td>20 A</td> <td>P_{acr} (cosφ= ± 0.9)</td> <td>2700 W @ 45 °C amb.</td> </tr> <tr> <td></td> <td></td> <td>I_{ac} max</td> <td>15 A</td> </tr> </table>		V_{dc} max	600 V	V_{acr}	230 V 1Ø	V_{dc} MPP	80 - 580 V	f_r	50 Hz	V_{dc}, Full Power	200 - 500 V	S_{max}	3000 VA	I_{dc} max	16 A	P_{acr} (cosφ= 1)	3000 W @ 45 °C amb.	I_{sc} max	20 A	P_{acr} (cosφ= ± 0.9)	2700 W @ 45 °C amb.			I_{ac} max	15 A	<table border="1"> <tr> <td>V_{acr}</td> <td>230 V 1Ø</td> </tr> <tr> <td>f_r</td> <td>50 Hz</td> </tr> <tr> <td>S_{max}</td> <td>3000 VA</td> </tr> <tr> <td>P_{acr} (cosφ= 1)</td> <td>3000 W @ 45 °C amb.</td> </tr> <tr> <td>P_{acr} (cosφ= ± 0.9)</td> <td>2700 W @ 45 °C amb.</td> </tr> <tr> <td>I_{ac} max</td> <td>15 A</td> </tr> </table>		V_{acr}	230 V 1Ø	f_r	50 Hz	S_{max}	3000 VA	P_{acr} (cosφ= 1)	3000 W @ 45 °C amb.	P_{acr} (cosφ= ± 0.9)	2700 W @ 45 °C amb.	I_{ac} max	15 A
V_{dc} max	600 V	V_{acr}	230 V 1Ø																																				
V_{dc} MPP	80 - 580 V	f_r	50 Hz																																				
V_{dc}, Full Power	200 - 500 V	S_{max}	3000 VA																																				
I_{dc} max	16 A	P_{acr} (cosφ= 1)	3000 W @ 45 °C amb.																																				
I_{sc} max	20 A	P_{acr} (cosφ= ± 0.9)	2700 W @ 45 °C amb.																																				
		I_{ac} max	15 A																																				
V_{acr}	230 V 1Ø																																						
f_r	50 Hz																																						
S_{max}	3000 VA																																						
P_{acr} (cosφ= 1)	3000 W @ 45 °C amb.																																						
P_{acr} (cosφ= ± 0.9)	2700 W @ 45 °C amb.																																						
I_{ac} max	15 A																																						
 -25 to + 60 °C -13 to +140 °F																																							

1	ABB	 <small>DIN V VDE V 0126-1-1</small> <small>PROTECTIVE CLASS:</small>	 <small>Made in Italy</small>																																				
3	www.abb.com/solar SOLAR INVERTER	2	MODEL: UNO-3.6-TL-OUTD																																				
<table border="1"> <tr> <td>V_{dc} max</td> <td>850 V</td> <td>V_{acr}</td> <td>230 V 1Ø</td> </tr> <tr> <td>V_{dc} MPP</td> <td>350 - 820 V</td> <td>f_r</td> <td>50 Hz</td> </tr> <tr> <td>V_{dc}, Full Power</td> <td>380 - 700 V</td> <td>S_{max}</td> <td>3600 VA</td> </tr> <tr> <td>I_{dc} max</td> <td>11 A</td> <td>P_{acr} (cosφ= 1)</td> <td>3600 W @ 45 °C amb.</td> </tr> <tr> <td>I_{sc} max</td> <td>15 A</td> <td>P_{acr} (cosφ= ± 0.9)</td> <td>3240 W @ 45 °C amb.</td> </tr> <tr> <td></td> <td></td> <td>I_{ac} max</td> <td>16 A</td> </tr> </table>		V_{dc} max	850 V	V_{acr}	230 V 1Ø	V_{dc} MPP	350 - 820 V	f_r	50 Hz	V_{dc}, Full Power	380 - 700 V	S_{max}	3600 VA	I_{dc} max	11 A	P_{acr} (cosφ= 1)	3600 W @ 45 °C amb.	I_{sc} max	15 A	P_{acr} (cosφ= ± 0.9)	3240 W @ 45 °C amb.			I_{ac} max	16 A	<table border="1"> <tr> <td>V_{acr}</td> <td>230 V 1Ø</td> </tr> <tr> <td>f_r</td> <td>50 Hz</td> </tr> <tr> <td>S_{max}</td> <td>3600 VA</td> </tr> <tr> <td>P_{acr} (cosφ= 1)</td> <td>3600 W @ 45 °C amb.</td> </tr> <tr> <td>P_{acr} (cosφ= ± 0.9)</td> <td>3240 W @ 45 °C amb.</td> </tr> <tr> <td>I_{ac} max</td> <td>16 A</td> </tr> </table>		V_{acr}	230 V 1Ø	f_r	50 Hz	S_{max}	3600 VA	P_{acr} (cosφ= 1)	3600 W @ 45 °C amb.	P_{acr} (cosφ= ± 0.9)	3240 W @ 45 °C amb.	I_{ac} max	16 A
V_{dc} max	850 V	V_{acr}	230 V 1Ø																																				
V_{dc} MPP	350 - 820 V	f_r	50 Hz																																				
V_{dc}, Full Power	380 - 700 V	S_{max}	3600 VA																																				
I_{dc} max	11 A	P_{acr} (cosφ= 1)	3600 W @ 45 °C amb.																																				
I_{sc} max	15 A	P_{acr} (cosφ= ± 0.9)	3240 W @ 45 °C amb.																																				
		I_{ac} max	16 A																																				
V_{acr}	230 V 1Ø																																						
f_r	50 Hz																																						
S_{max}	3600 VA																																						
P_{acr} (cosφ= 1)	3600 W @ 45 °C amb.																																						
P_{acr} (cosφ= ± 0.9)	3240 W @ 45 °C amb.																																						
I_{ac} max	16 A																																						
 -25 to + 60 °C -13 to +140 °F																																							

1	ABB	 <small>DIN V VDE V 0126-1-1</small> <small>PROTECTIVE CLASS:</small>	 <small>Made in Italy</small>																																				
3	www.abb.com/solar SOLAR INVERTER	2	MODEL: UNO-4.2-TL-OUTD																																				
<table border="1"> <tr> <td>V_{dc} max</td> <td>850 V</td> <td>V_{acr}</td> <td>230 V 1Ø</td> </tr> <tr> <td>V_{dc} MPP</td> <td>350 - 820 V</td> <td>f_r</td> <td>50 Hz</td> </tr> <tr> <td>V_{dc}, Full Power</td> <td>380 - 700 V</td> <td>S_{max}</td> <td>4200 VA</td> </tr> <tr> <td>I_{dc} max</td> <td>12.5 A</td> <td>P_{acr} (cosφ= 1)</td> <td>4200 W @ 45 °C amb.</td> </tr> <tr> <td>I_{sc} max</td> <td>15 A</td> <td>P_{acr} (cosφ= ± 0.9)</td> <td>3780 W @ 45 °C amb.</td> </tr> <tr> <td></td> <td></td> <td>I_{ac} max</td> <td>20 A</td> </tr> </table>		V_{dc} max	850 V	V_{acr}	230 V 1Ø	V_{dc} MPP	350 - 820 V	f_r	50 Hz	V_{dc}, Full Power	380 - 700 V	S_{max}	4200 VA	I_{dc} max	12.5 A	P_{acr} (cosφ= 1)	4200 W @ 45 °C amb.	I_{sc} max	15 A	P_{acr} (cosφ= ± 0.9)	3780 W @ 45 °C amb.			I_{ac} max	20 A	<table border="1"> <tr> <td>V_{acr}</td> <td>230 V 1Ø</td> </tr> <tr> <td>f_r</td> <td>50 Hz</td> </tr> <tr> <td>S_{max}</td> <td>4200 VA</td> </tr> <tr> <td>P_{acr} (cosφ= 1)</td> <td>4200 W @ 45 °C amb.</td> </tr> <tr> <td>P_{acr} (cosφ= ± 0.9)</td> <td>3780 W @ 45 °C amb.</td> </tr> <tr> <td>I_{ac} max</td> <td>20 A</td> </tr> </table>		V_{acr}	230 V 1Ø	f_r	50 Hz	S_{max}	4200 VA	P_{acr} (cosφ= 1)	4200 W @ 45 °C amb.	P_{acr} (cosφ= ± 0.9)	3780 W @ 45 °C amb.	I_{ac} max	20 A
V_{dc} max	850 V	V_{acr}	230 V 1Ø																																				
V_{dc} MPP	350 - 820 V	f_r	50 Hz																																				
V_{dc}, Full Power	380 - 700 V	S_{max}	4200 VA																																				
I_{dc} max	12.5 A	P_{acr} (cosφ= 1)	4200 W @ 45 °C amb.																																				
I_{sc} max	15 A	P_{acr} (cosφ= ± 0.9)	3780 W @ 45 °C amb.																																				
		I_{ac} max	20 A																																				
V_{acr}	230 V 1Ø																																						
f_r	50 Hz																																						
S_{max}	4200 VA																																						
P_{acr} (cosφ= 1)	4200 W @ 45 °C amb.																																						
P_{acr} (cosφ= ± 0.9)	3780 W @ 45 °C amb.																																						
I_{ac} max	20 A																																						
 -25 to + 60 °C -13 to +140 °F																																							

Besides the label with the specifications, an additional inverter identification label is also provided.

The label displays the following information:

ABB UNO-X.X-TL-OUTD-Y   P/N: P P P P P P P P P P  SN: YYWWSSSSSS WK: WWYY  WO: XXXXXXXX  SO: SXXXXXXXXX Q1	<ul style="list-style-type: none"> • Inverter model <ul style="list-style-type: none"> - X.X = Inverter power rating: - Y = Integrated disconnect switch • Inverter Part Number • Inverter Serial Number consisting of: <ul style="list-style-type: none"> - YY = Year of manufacture - WW = Week of manufacture - SSSSSS = sequential number • Week/Year of manufacture
---	---



The officially required information is located on the approval label. The identification label is an accessory label which shows the information necessary for the identification and characterisation of the inverter by ABB.



Note: The labels are NOT to be hidden by foreign objects and parts (rags, boxes, equipment, etc.); they must be regularly cleaned and always kept in sight.

Characteristics and technical data

	UNO-2.0-TL-OUTD	UNO-3.0-TL-OUTD
Input		
Absolute Maximum Input Voltage ($V_{max,abs}$)	600 V	
Input start-up voltage (V_{start})	100...300 V (default 150 V)	
Input operating interval ($V_{dcrmin}...V_{dcrmax}$)	0.7x V_{start} ...580 V (min 80V)	
Rated Input Voltage (V_{dcr})	400 V	
Input Nominal Power (P_{dcr})	2200 W	3200 W
Number of Independent MPPT	1	
Maximum input power (PMPPTmax)	2200 W	3200 W
DC Voltage MPPT Interval ($V_{MPPTmin} ... V_{MPPTmax}$) to P_{acr}	180...500 V	200...500 V
Maximum DC Input Current (I_{dcrmax})	12.5 A	16.0 A
Maximum Return current (AC side vs DC side)	< 5 mA ⁽³⁾	
Maximum short circuit current (I_{scmax})	15.0 A	20.0 A
Number of DC Connection Pairs in Input	1	
Type of Input DC Connectors	Quick-fit PV connector ⁽⁴⁾	
Type of photovoltaic panels that can be connected at input according to IEC 61730	Class A	
Input protection		
Reverse Polarity Protection	Yes, from current limited source	
Input overvoltage protection - Varistors	Yes	
Insulation Check	Complying with the local standard	
Characteristics of DC disconnect switch (Version -S)	Max. 25 A / 600 V	
Output		
AC Connection to the grid	Single phase	
Nominal Output Power ($P_{acr} @\cos\phi=1$)	2000 W	3000 W
Maximum Output Power ($P_{acmax} @\cos\phi=1$)	2000 W	3000 W
Maximum apparent Output power (S_{max})	2000 VA	3000 VA
Rated AC Output Voltage (V_{acr})	230 V	
Output voltage range ($V_{acmin}...V_{acmin}$)	180...264 V ⁽¹⁾	
Maximum output current (I_{acmax})	10.0 A	15.0 A
Maximum fault current	18.3 A rms (200ms)	
Contribution to short-circuit current	12.0 A	17.0 A
Inrush current	Negligible	
Rated Output Frequency (fr)	50 / 60 Hz	
Output Frequency Range ($f_{min}...f_{max}$)	47...53 Hz / 57...63 Hz ⁽²⁾	
Nominal power factor and setting interval	> 0.995 adj. \pm 0.8 at maximum S_{max}	
Total Current Harmonic Distortion	<3%	
AC Connections Type	Female connector from panel	
Output protection		
Anti-islanding Protection	Complying with the local standard	
Maximum AC overcurrent protection	16.0 A	20.0 A
Output overvoltage protection - Varistors	2 (L - N / L - PE)	
Operating performance		
Maximum Efficiency (η_{max})	97.3%	
Weighted Efficiency (EURO/CEC)	96.0% / -	
Power Supply Threshold	8.0 W	
Night-time consumption	< 0.1W	

	UNO-2.0-TL-OUTD	UNO-3.0-TL-OUTD
Communication		
Remote Monitoring	VSN300 Wifi Logger Card (opt.), VSN700 Data Logger (opt.)	
Wireless local monitoring	VSN300 Wifi Logger Card (opt.)	
User Interface	LCD Display with 16 characters x 2 lines	
Wired local monitoring	PVI-USB-RS232_485 (opt.)	
Available ports	RS485, Remote ON/OFF, Alarm Relay	
Expansion slot	1	
Environmental		
Ambient temperature	-25...+ 60 °C/-13...140 °F with derating above 45°C / 113°F	
Relative Humidity	0...100% w/o condensation	
Typical noise emission pressure	50 dB(A) @ 1 m	
Maximum operating altitude without derating	2000 m / 6560 ft	
Environmental pollution degree classification for external environments	3	
Environmental category	Outdoor	
Physical		
Environmental Protection Rating	IP 65	
Cooling System	Natural	
Dimensions (H x W x D)	553mm x 418mm x 175mm / 21.8" x 16.5" x 6.9"	
Weight	12 kg / 26.5 lb	
Assembly System	Wall bracket	
Overvoltage rating as per IEC 62109-1	II (DC input) III (AC output)	
Safety		
Safety class	I	
Insulation Level	Without transformer (TL)	
CE Marking	(50 Hz Only)	
Safety and EMC Standards	IEC/EN 62109-1, IEC/EN 62109-2, EN 61000-6-2, EN 61000-6-3, EN 61000-3-2, EN 61000-3-3	
Other features		
Function for managing loads	GoGo Relay	



1. The output voltage range may vary according to the grid standard of the country of installation
2. The output frequency range may vary according to the grid standard of the country of installation
3. In the event of a fault, limited by the external protection envisaged on the AC circuit
4. Please refer to the document "String inverters – Product manual appendix" available at www.abb.com/solarinverters for information on the quick-fit connector brand and model used in the inverter.

Note. Features not specifically mentioned in this data sheet are not included in the product

	UNO-3.6-TL-OUTD	UNO-4.2-TL-OUTD
Input		
Absolute Maximum Input Voltage (V _{max,abs})	850 V	
Input start-up voltage (V _{start})	300...600 V (default 380 V)	
Input operating interval (V _{dcmi} ...V _{dcmx})	350...820V	
Rated Input Voltage (V _{dcr})	500 V	600 V
Input Nominal Power(P _{dcr})	3900 W	4500 W
Number of Independent MPPT	1	
Maximum input power (P _{MPPTmax})	3900 W	4500 W
DC Voltage MPPT Interval (V _{MPPTmin} ... V _{MPPTmax}) to P _{acr}	380...700 V	
Maximum DC Input Current (I _{dcmx})	11.0 A	12.5 A
Maximum Return current (AC side vs DC side)	4.7 A ⁽³⁾	
Maximum short-circuit current	15.0 A	
Number of DC Connection Pairs in Input	1	
Type of Input DC Connectors	Quick-fit PV connector ⁽⁴⁾	
Type of photovoltaic panels that can be connected at input according to IEC 61730	Class A	
Input protection		
Reverse Polarity Protection	Yes, from current limited source	
Input overvoltage protection - Varistors	Yes	
Insulation Check	Complying with the local standard	
Characteristics of DC disconnect switch (Version -S)	Max. 16 A / 1000 V	
Output		
AC Connection to the grid	Single phase	
Nominal Output Power (P _{acr} @cosφ=1)	3600 W	4200 W
Maximum Output Power (P _{acmax} @cosφ=1)	3600 W	4200 W
Maximum apparent Output power (S _{max})	3600 VA	4200 VA
Rated AC output voltage (V _{acr})	230 V	
Output voltage range (V _{acmi} ...V _{acmx})	180...264 V ⁽¹⁾	
Maximum output current (I _{acmx})	16.0 A	20.0 A
Maximum fault current	22.9 A rms (20ms)	
Contribution to short-circuit current	18.0 A	22.0 A
Inrush current	Negligible	
Rated Output Frequency (fr)	50 / 60 Hz	
Output Frequency Range (f _{mi} ...f _{mx})	47...53 Hz / 57...63 Hz ⁽²⁾	
Nominal power factor and setting interval	> 0.995 adj. ± 0.8 at maximum S _{max}	
Total Current Harmonic Distortion	<3%	
AC Connections Type	Female connector from panel	
Output protection		
Anti-islanding Protection	Complying with the local standard	
Maximum AC overcurrent protection	20.0 A	25.0 A
Output Overvoltage Protection - Varistors	2 (L - N / L - PE)	
Operating performance		
Maximum Efficiency (η _{max})	98.4%	
Weighted Efficiency (EURO/CEC)	97.5% / -	
Power Supply Threshold	8.0 W	
Night-time consumption	< 0.1W	

	UNO-3.6-TL-OUTD	UNO-4.2-TL-OUTD
Communication		
Remote Monitoring	VSN300 Wifi Logger Card (opt.), VSN700 Data Logger (opt.)	
Wireless local monitoring	VSN300 Wifi Logger Card (opt.)	
User Interface	LCD Display with 16 characters x 2 lines	
Wired local monitoring	PVI-USB-RS232_485 (opt.)	
Available ports	RS485, Remote ON/OFF, Alarm Relay	
Expansion slot	1	
Environmental		
Ambient temperature	-20...+ 60 °C/-13...140 °F with derating above 45°C / 113°F	
Relative Humidity	0...100% w/o condensation	
Typical noise emission pressure	50 dB(A) @ 1 m	
Maximum operating altitude without derating	2000 m / 6560 ft	
Environmental pollution degree classification for external environments	3	
Environmental category	Outdoor	
Physical		
Environmental Protection Rating	IP 65	
Cooling System	Natural	
Dimensions (H x W x D)	553mm x 418mm x 175mm / 21.8" x 16.5" x 6.9"	
Weight	12 kg / 26.5 lb	
Assembly System	Wall bracket	
Overvoltage rating as per IEC 62109-1	II (DC input) III (AC output)	
Safety		
Safety class	I	
Insulation Level	Without transformer (TL)	
CE Marking	(50 Hz Only)	
Safety and EMC Standards	EN 50178, IEC/EN 62109-1, IEC/EN 62109-2, EN 61000-6-2, EN 61000-6-3, EN 61000-3-2, EN 61000-3-3	
Other features		
Function for managing loads	GoGo Relay	



1. The output voltage range may vary according to the grid standard of the country of installation
2. The output frequency range may vary according to the grid standard of the country of installation
3. In the event of a fault, limited by the external protection envisaged on the AC circuit
4. Please refer to the document "String inverters – Product manual appendix" available at www.abb.com/solarinverters for information on the quick-fit connector brand and model used in the inverter.

Note. Features not specifically mentioned in this data sheet are not included in the product

Tightening torques

To maintain the IP65 protection of the system and for optimal installation, the following tightening torques must be used:

AC output connector cable gland ⑩ (ring nut fastening)	4...5 Nm
Screws for securing AC output connector cables gland	0.8...1 Nm
Service cable glands ⑳ M20 (ring nut fastening)	2.5 Nm
Service cable glands ⑳ M20 (lock nut fastening)	7.0 Nm
Front cover fastening screws ①⑤	2.5 Nm
RS485 connector cable gland ⑭ (ring nut fastening)	0.8 Nm
Locking screws ①②	2.5 Nm
Screw for external ground connection ①⑨	2.5 Nm

Overall dimensions

The overall dimensions are expressed in millimetres and inches and include the wall installation bracket.

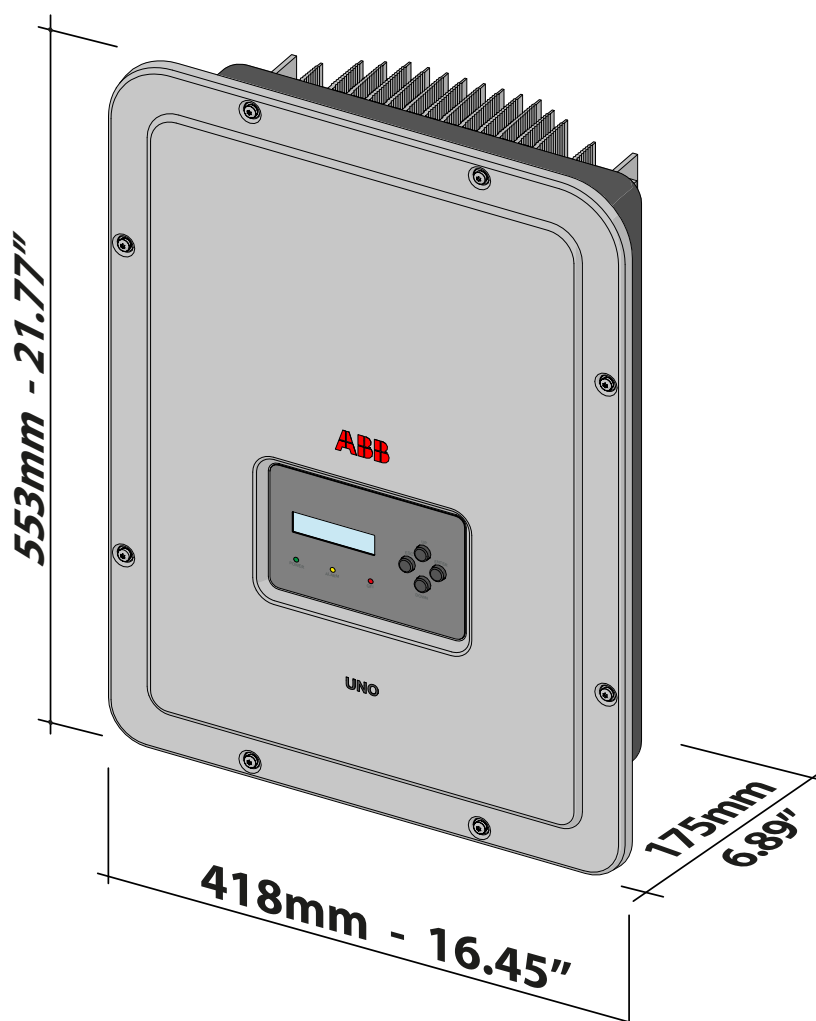

Bracket dimensions

The dimensions of the wall mounting bracket are expressed in mm and inches.

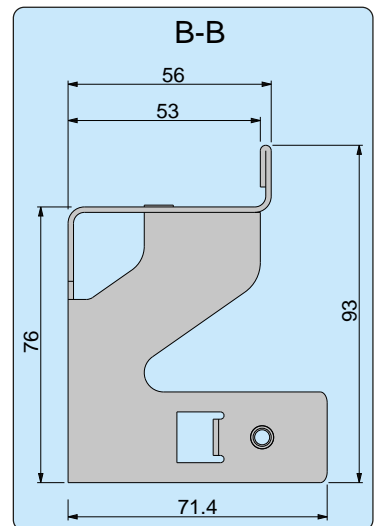
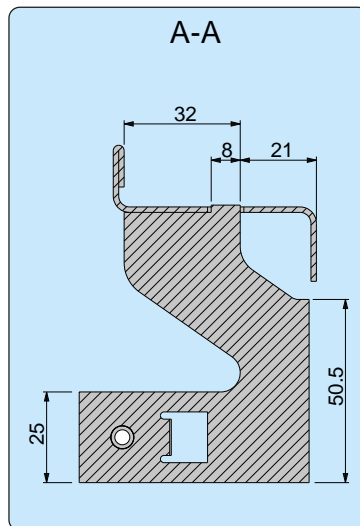
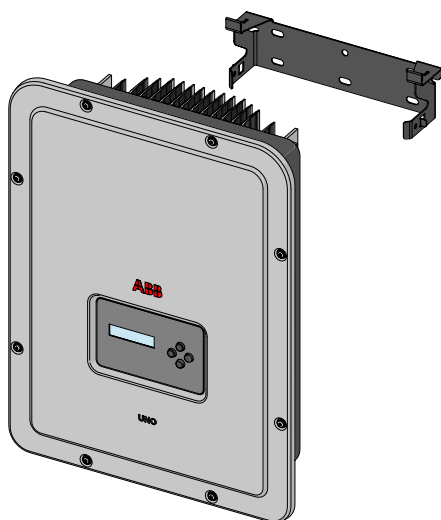
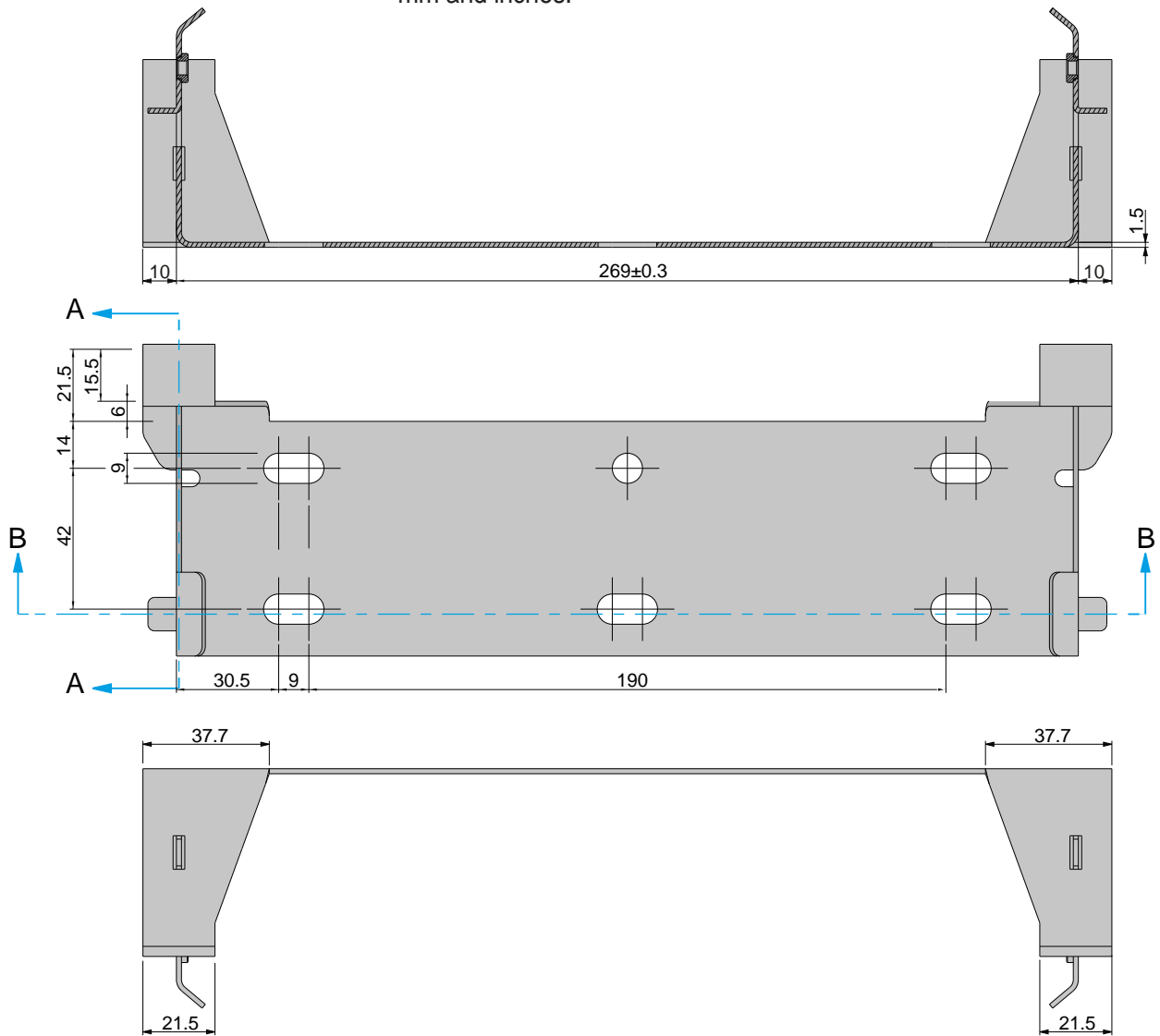

000469AG

Efficiency curves

The equipment was designed considering current energy conservation standards, to avoid waste and unnecessary leakage.

Graphs of the efficiency curves of all models of inverter described in this manual are shown below.

The efficiency curves are linked to technical parameters that are continually being developed and improved and should therefore be considered approximate.



UNO-2.0-TL-OUTD UNO-2.0-TL-OUTD-S

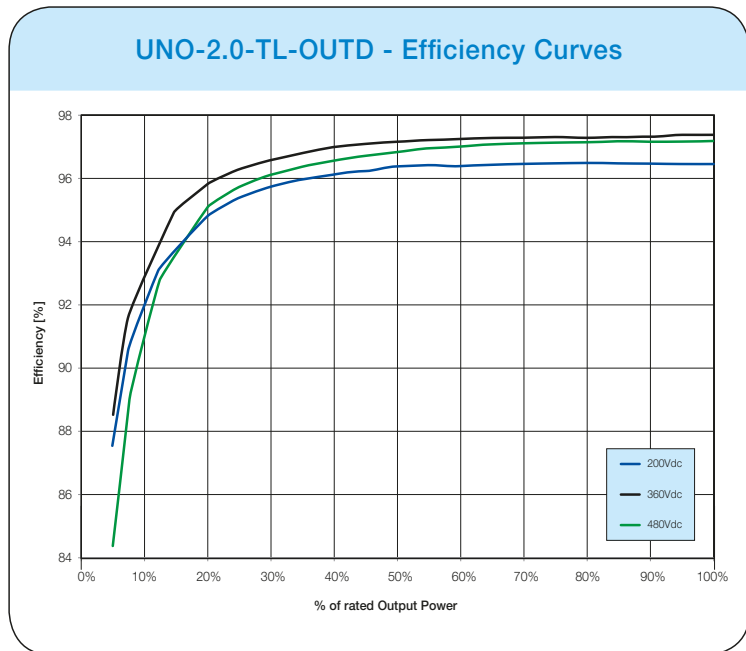

UNO-3.0-TL-OUTD UNO-3.0-TL-OUTD-S

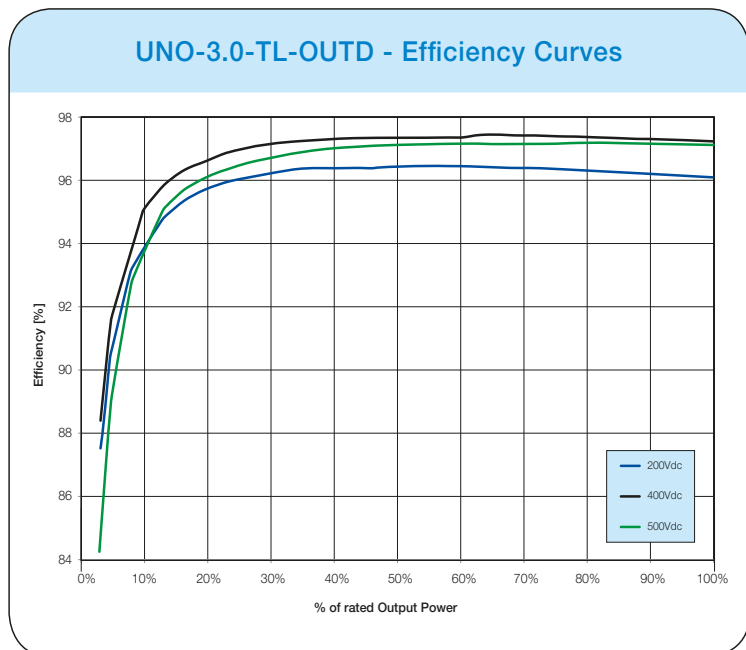

UNO-3.6-TL-OUTD
UNO-3.6-TL-OUTD-S

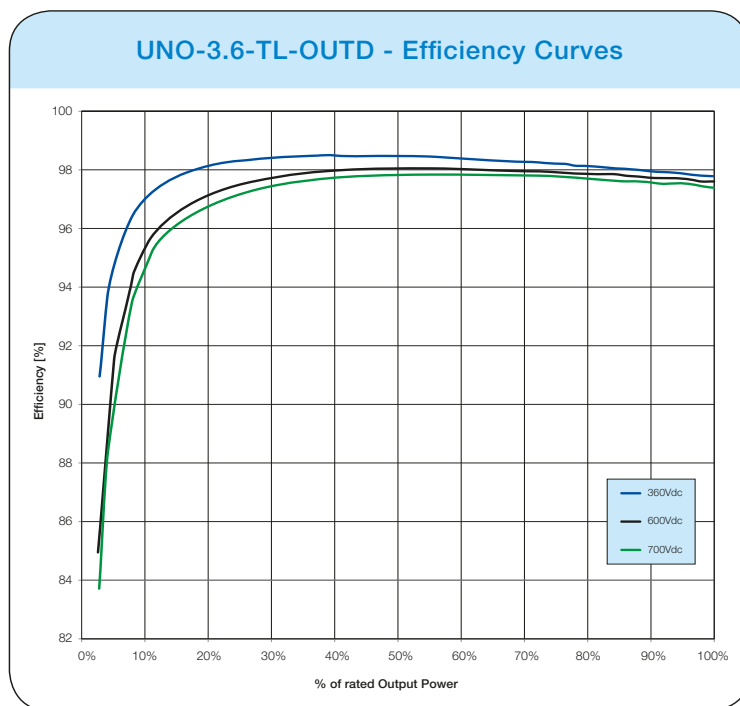

UNO-4.2-TL-OUTD
UNO-4.2-TL-OUTD-S

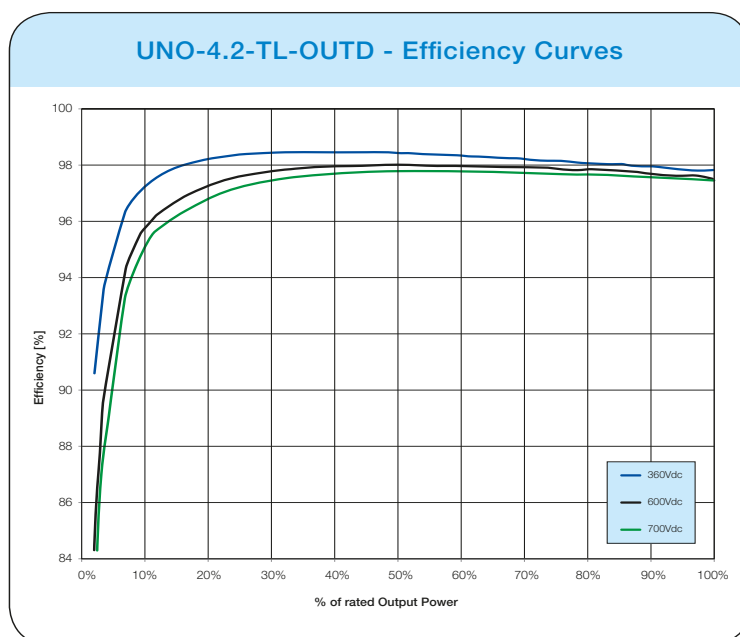

Power limitation (Power Derating)

In order to allow inverter operation in safe thermal and electrical conditions, the unit automatically reduces the value of the power fed into the grid.

Power limiting may occur due to:

- Adverse environmental conditions (thermal derating)
- Percentage of output power (value set by the user)
- Grid voltage over frequency (mode set by user)
- Grid overvoltage $U > 10\text{min Der.}$ (enabling carried out by user)
- Anti-islanding
- High input voltage values
- High input current values.



Power reduction due to environmental conditions

The power reduction value and the inverter temperature at which it occurs depend on the ambient temperature and on many operating parameters. Example: input voltage, grid voltage and power available from the photovoltaic field.

The inverter can therefore reduce the power during certain periods of the day according to the value of these parameters.

In any case, the inverter guarantees the maximum output power even at high temperatures, provided the sun is not shining directly on it.

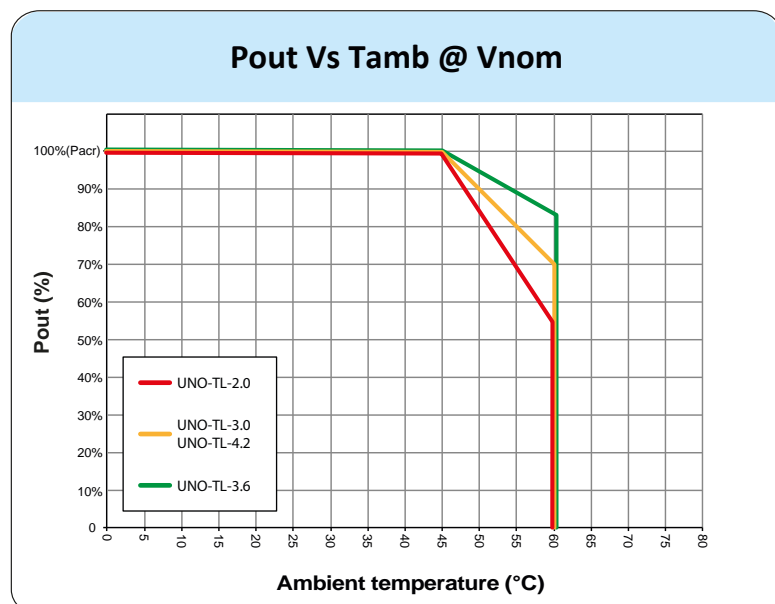

Power reduction due to the input voltage

The graphs show the automatic reduction of supplied power when input voltage values are too high or too low.

PVI-2.0-TL-OUTD
PVI-2.0-TL-OUTD-S
PVI-3.0-TL-OUTD
PVI-3.0-TL-OUTD-S

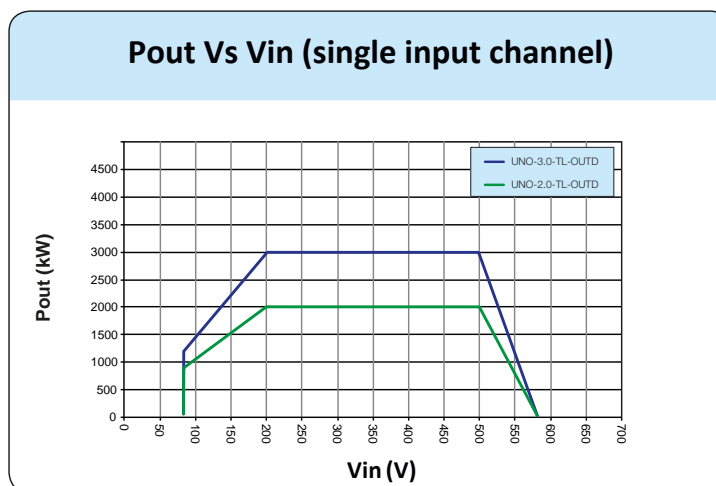

PVI-3.6-TL-OUTD
PVI-3.6-TL-OUTD-S
PVI-4.2-TL-OUTD
PVI-4.2-TL-OUTD-S

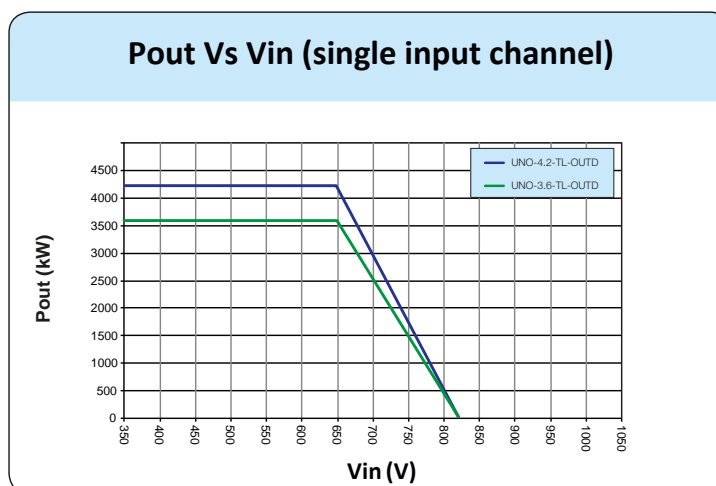

Characteristics of a photovoltaic generator

A PV generator consists of an assembly of photovoltaic modules that transform solar radiation into DC electrical energy and can be made up of:

Strings: number (X) of PV modules connected in series

Array: group of X strings connected in parallel



Strings and Arrays

The string technology was developed to significantly reduce the installation costs of a photovoltaic system, mainly associated to wiring on the DC side of the inverter and subsequent distribution on the AC side. A photovoltaic panel consists of many photovoltaic cells mounted on the same support.

- A string consists of a certain number of panels connected in series.
- An array consists of two or more strings connected in parallel.

Large photovoltaic systems can include multiple arrays connected to one or more inverters.

The greater the number of panels in each string, the lower the cost and the less complex the wiring connections of the system.

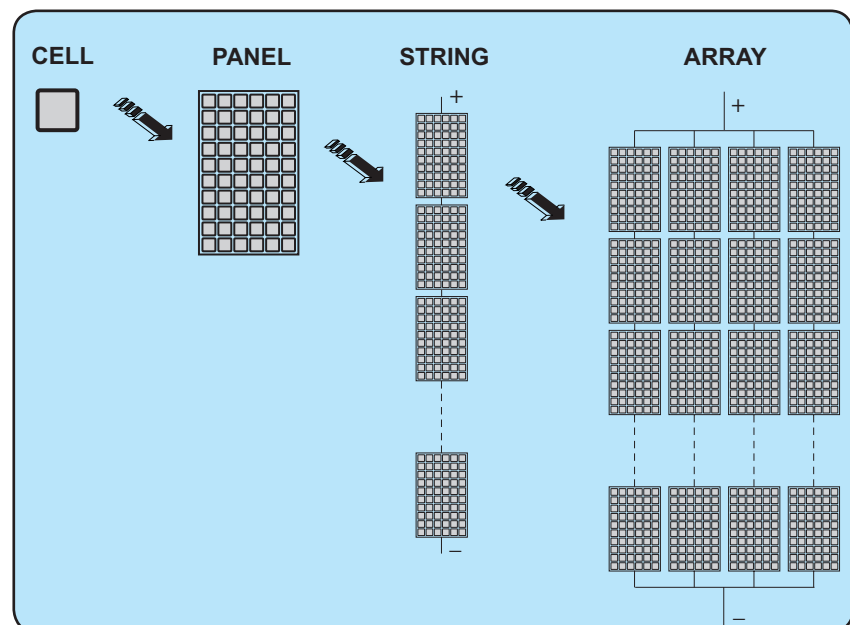

The current of each array must fall within the limits of the inverter.

Description of the equipment

This equipment is a string inverter which converts the direct current of a photovoltaic generator into alternating current and feeds it into the public distribution grid.

Photovoltaic panels convert solar radiation into “DC” electrical energy (via a photovoltaic field, also called PV generator); in order to use it, it is transformed into “AC” alternating current. This conversion, known as inversion from DC to AC, is done in an efficient way by the ABB inverters, without using any rotary elements, rather only via static electronic systems.

In order to allow inverter operation in safe thermal and electrical conditions, the unit automatically reduces the value of the power fed into the grid under adverse environmental conditions or unsuitable input voltage values.

When connected in parallel with the grid, the alternating current from the inverter flows directly into the domestic or industrial distribution circuit, which is in turn connected to the public distribution grid.

This way the solar energy system compensates for the energy drawn from the utilities connected to the grid to which it is linked.

When the photovoltaic system is not generating sufficient energy, the power required to ensure proper operation of connected loads is taken from the public distribution grid. While if too much energy is produced, it is directly fed to the grid, thus becoming available to other users.

According to national and local standards and regulations the produced energy can be sold to the grid or credited to the user against future consumption, thus granting a great saving of money.



Operating diagram

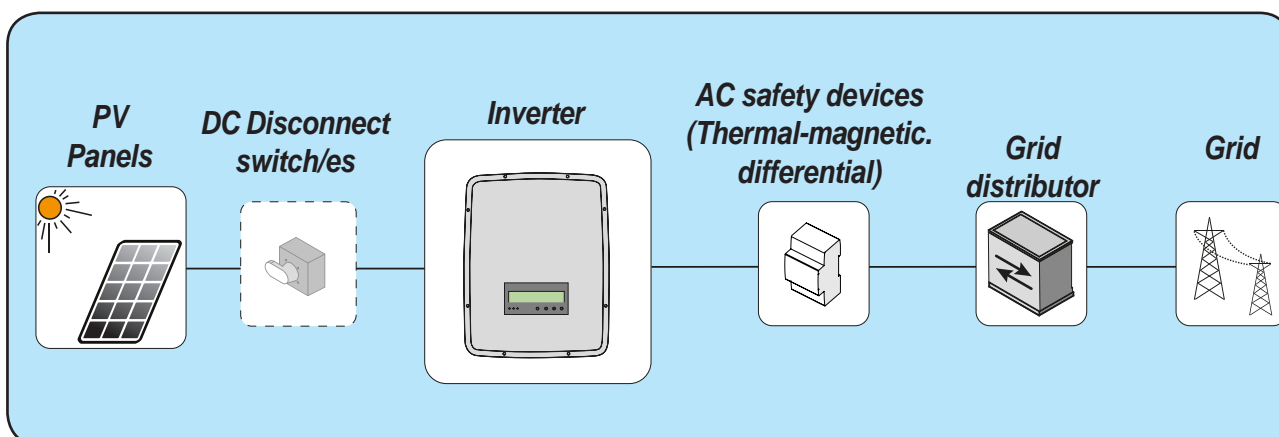

Mutual connection of multiple inverters

If the photovoltaic system exceeds the capacity of a single inverter, it is possible to connect multiple inverters to the system, each of them in turn connected on the DC side to an appropriate section of the photovoltaic generator, and on the AC side to the distribution grid.

Each string inverter will work independently of the others and its own photovoltaic module will supply the maximum power available to the grid.



Notes on the system sizing

Decisions on how to structure a photovoltaic system depend on a series of factors and considerations, such as the type of panels, the space availability, the future location of the system, energy production goals over the long term, etc.

A configuration program that can help to correctly size the photovoltaic system is available on the ABB website (<http://stringsizer.abb.com>).

Functionality and components of the equipment

Configurable relay

The inverter is equipped with a configurable switching relay, which can be used in different operating configurations that can be set in the dedicated menu. A typical example of application is the activation of the relay in the event of an alarm.

Remote switch-on/switch-off

This command can be used to switch off/switch on the inverter via an external (remote) command.

This function must be enabled in the menu and when active, switching on the inverter, besides being dictated by the presence of normal parameters which allow the inverter to be connected to the grid, also depends on the external command for switching on/off.



Reactive power feed into the grid

The inverter is able to produce reactive power and can feed this power into the grid via the phase factor setting. Managing the feed can be controlled directly by the grid company via a dedicated RS485 serial interface or set by the display or through the configuration software, Aurora Manager TL.

Power feeding modes vary according to the country of installation and the grid companies. For detailed information on the parameters and characteristics of this function, contact **ABB** directly.

Limiting the active power fed into the grid

The inverter, if enabled and set using the display or the Aurora Manager configuration software, can limit the amount of active power fed into the grid by the inverter to the desired value (expressed as a percentage).

Data transmission and control

The inverter or a network of several inverters, can also be monitored remotely via an advanced communication system based on an RS485 serial interface. The range of optional ABB devices that can be connected to this communication line allow you to monitor the device locally or remotely through an internet connection.

MicroSD Card

The inverter is equipped with a slot for insertion of a microSD memory Card.

The maximum size of the microSD Card is 4 GB. Its main functionality is allowing the inverter firmware to be updated in a few simple steps.

The most up-to-date inverter firmware version is available from the website <https://registration.abbsolarinverters.com>

Remote Firmware Update Function

The inverter firmware can be updated remotely using the accessory boards which are compatible with the inverter. For further information, refer to the website or contact ABB.

Stand by Mode

This functionality allows the inverter to remain on and connected to the grid even with an input voltage of less than the minimum required for operation. It is particularly useful in conditions of low irradiation and with passing shadowed areas that would cause continuous connections and disconnections to the grid. Instead, with this functionality, the inverter starts to deliver power as soon as the input voltage exceeds the minimum for re-activation without having to repeat the grid connection sequence. The time in which the inverter remains in this state can be set by accessing the Settings menu and activating the time for Input Undervoltage Protection (T_{protUV}). If within the set time the conditions to export grid power do not reoccur, the inverter disconnects from the grid.



Topographic diagram of the equipment UNO-2.0/3.0-TL-OUTD

The diagram summarises the internal structure of the inverter.

The internal circuitry of the 2 and 3kW power levels is with double stage conversion and therefore consists of:

- DC/DC input converter (booster)
- DC-AC output inverter

The DC-DC converter and the DC-AC inverter both work at a high switching frequency and are therefore small and relatively light.

The input converter is dedicated to a single string/array and is equipped with a maximum power point tracking (MPPT) function.



This inverter version is of the transformerless type, that is without galvanic insulation between the input and the output. This allows the conversion efficiency to be increased further. The inverter is already equipped with all the protections necessary for safe operation and compliance with standards and regulations, even without the insulating transformer.

The connection to the power grid is therefore kept under control by two independent processors, in full compliance with the electric field regulations both for power supply to the systems as well as security.

The operating system carries out the task of communicating with its components in order to carry out data analysis.

In doing all this, we guarantee optimal operation of the whole assembly and a high performance in all sunlight conditions and always ensuring full compliance with the relevant directives, standards and regulations.

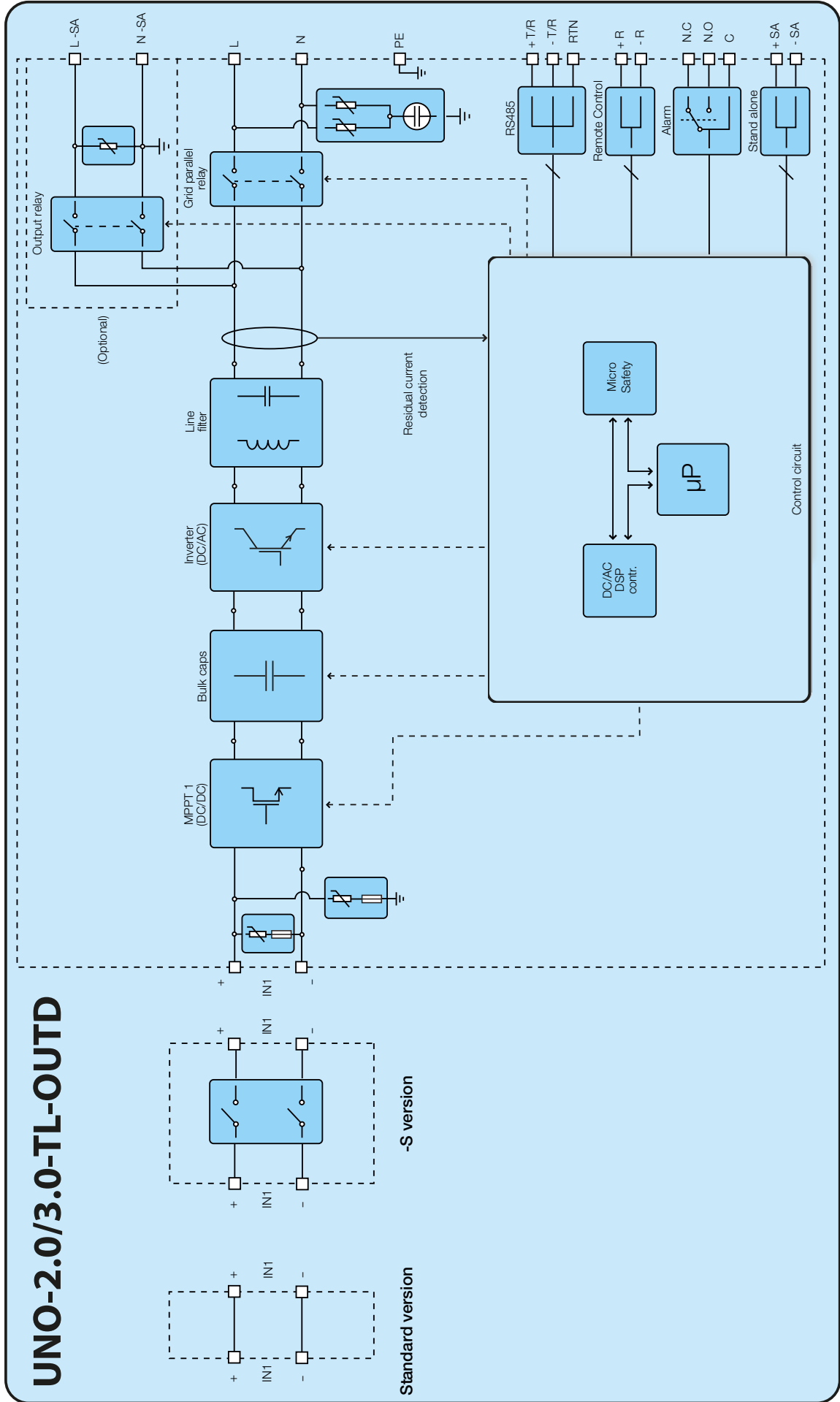

Topographic diagram of the equipment UNO-3.6/4.2-TL-OUTD

The diagram summarises the internal structure of the inverter.

The internal circuitry of the 3.6 to 4.2kW power levels is with single stage conversion and therefore consists only of:

- DC-AC output converter (Inverter);

The input voltage from the PV generator is directly converted into alternating output current; this requires a higher output voltage compared to other double stage versions of the inverter.



The DC-AC converter works at a high switching frequency which means it is small and relatively light.

The same converter is dedicated to a single string/array and is equipped with a maximum power point tracking (MPPT) function.

This inverter version is of the transformerless type, that is without galvanic insulation between the input and the output. This allows the conversion efficiency to be increased further. The inverter is already equipped with all the protections necessary for safe operation and compliance with standards and regulations, even without the insulating transformer.

The connection to the power grid is therefore kept under control by two independent computers, in full compliance with the electric field regulations both for power supply to the systems as well as security.

The operating system carries out the task of communicating with its components in order to carry out data analysis.

In doing all this, we guarantee optimal operation of the whole assembly and a high performance in all sunlight conditions and always ensuring full compliance with the relevant directives, standards and regulations.

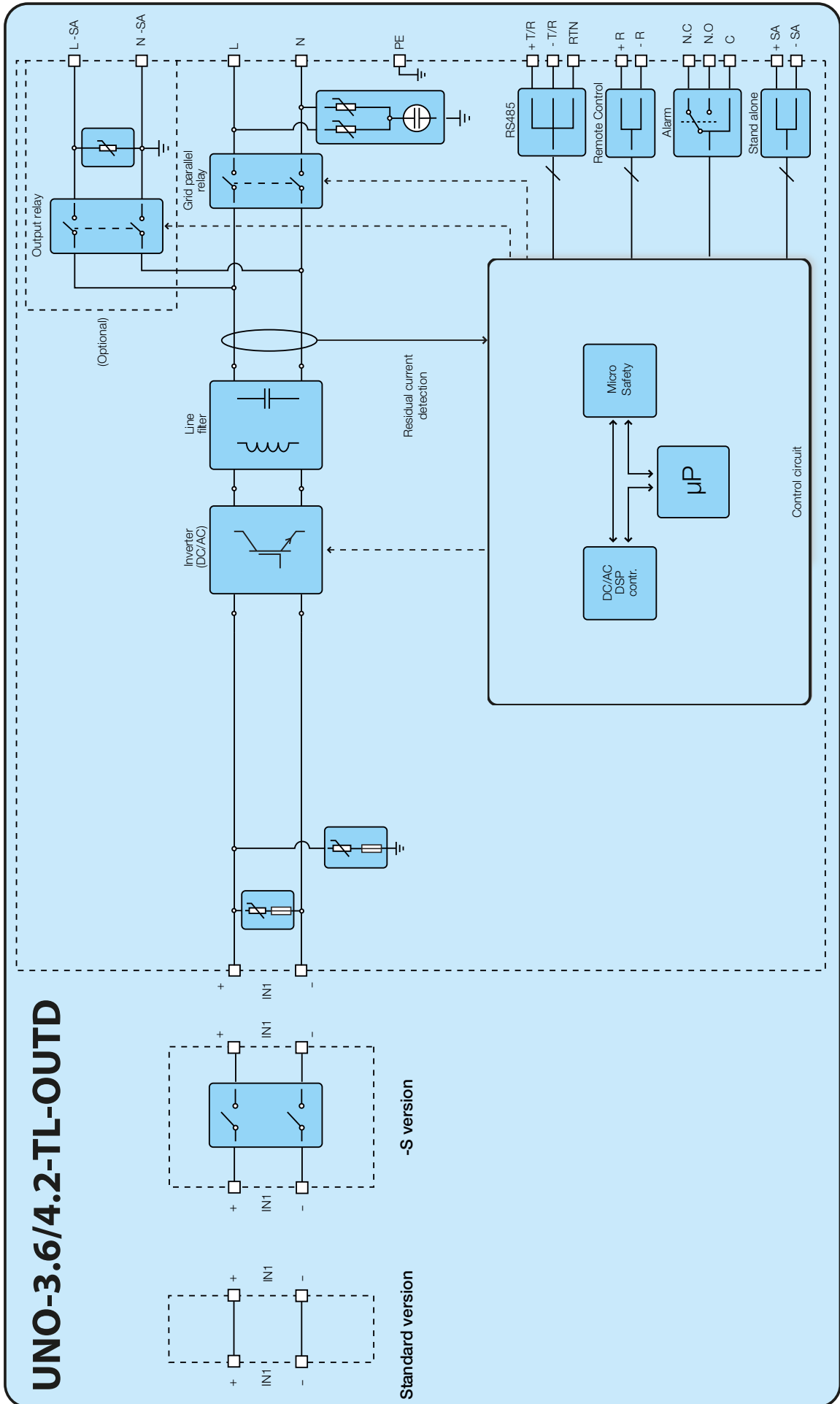

Safety devices

Anti-Islanding

In the event of a local grid outage by the electricity company, or when the equipment is switched off for maintenance operations, the inverter must be physically disconnected to ensure the protection of the people working on the grid, in accordance with the relevant national laws and regulations. To prevent possible islanding, the inverter is equipped with an automatic safety disconnection system called "Anti-Islanding".



Anti-islanding protection mechanisms are different depending on the grid standards, even if they all have the same purpose.

Ground fault of the photovoltaic panels

This inverter is to be used with panels connected in "floating" mode, i.e. with no earth connections on the positive and negative terminals. An advanced ground fault protection circuit continuously monitors the ground connection and disconnects the inverter when a ground fault indicating the fault condition by means of the red "GFI" LED on the front panel.

Other safety devices

The inverter is equipped with additional protective devices to ensure safe operation in any circumstance. These protections include:

- Constant monitoring of the grid voltage to ensure that voltage and frequency values remain within operating limits;
- Internal temperature control to automatically limit the power if necessary to prevent overheating of the unit (derating).

The numerous control systems determine a redundant structure to ensure absolutely safe operations.

Safety and accident prevention

3

Safety instructions and general information

The equipment has been manufactured in accordance with the strictest accident-prevention regulations and supplied with safety devices suitable for the protection of components and operators.



It is clearly impossible to anticipate the vast number of installations and environments in which the equipment will be installed. It is therefore necessary for the customer to appropriately inform the manufacturer about particular installation conditions.

ABB accepts no liability for failure to comply with the instructions for correct installation and will not be held responsible for systems upstream or downstream of the equipment it has supplied.



It is essential to provide operators with correct information. They must therefore read and comply with the technical information given in the manual and in the attached documentation.

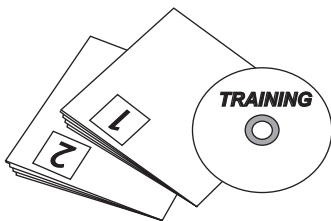

The instructions given in the manual do not replace the safety instructions and technical data for installation and operation displayed on the product, nor do they replace the safety regulations in force in the country of installation or common sense.

The manufacturer is willing to train staff, at its premises or on site, in accordance with conditions to be set out in the contract.



Do not use the equipment if you detect any operating anomalies.

Avoid improvised or temporary repairs. All repairs should be carried out using only original spare parts, which must be installed in accordance with their intended use.

Liabilities arising from commercial components are delegated to the respective manufacturers.

Hazardous areas and operations

Environmental conditions and risks

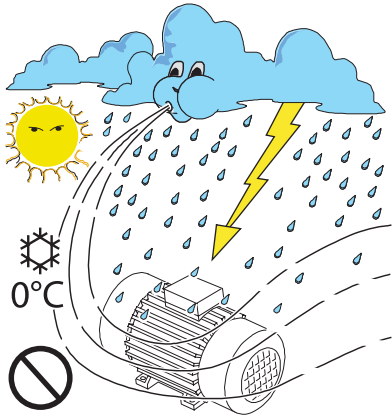

The equipment can be installed outdoors, but only in environmental conditions that do not prevent its regular operation. These conditions are listed in the technical data and in the installation chapter.

ABB IS NOT responsible for the disposal of the equipment: displays, cables, batteries, accumulators, etc., and therefore the customer must dispose of these items, which are potentially harmful to the environment, in accordance with the regulations in force in the country of installation.

The same precautions should be adopted for dismantling the equipment.



The equipment is not designed to operate in environments that are particularly inflammable or explosive.

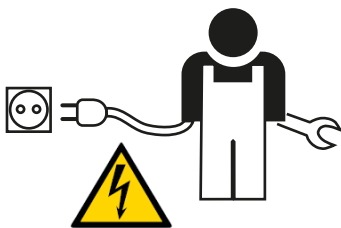

The customer and/or installer must appropriately train operators or anyone who may come into close proximity of the equipment, and highlight, with notices or other means where necessary, the hazardous areas or operations at risk: magnetic fields, hazardous voltages, high temperatures, possible discharges, generic hazard, etc.

Signs and labels



The labels affixed on the equipment must strictly NOT be removed, damaged, defaced, hidden, etc.

The labels must be regularly cleaned and kept in sight, i.e. NOT hidden by foreign objects and parts (rags, boxes, equipment, etc.)

The technical data provided in this manual does not in any case replace that shown on the labels affixed on the equipment.

Thermal and electrical hazard

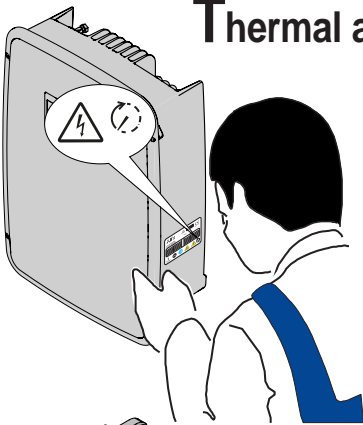

WARNING: the removal of guards or covers is only permitted after the voltage has been removed and time period indicated on the label has passed. This is to let the components cool down and allow the internal capacitors to discharge.

When the equipment has just been switched off, it may have hot parts as a result of overheating of the heated surfaces (e.g.: transformers, accumulators, coils, etc.) so be careful where you touch.

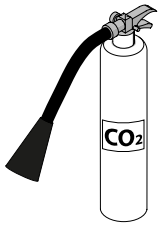

In the event of fire, use CO2 extinguishers and auto-extraction systems to extinguish the fire in closed environments.

Clothing and protection of personnel

ABB has done its best to eliminate sharp edges and corners, but as this is not always possible you are advised always to wear the clothing and personal protective equipment provided by the employer.



Personnel must not wear clothes or accessories that could start fires or generate electrostatic charges or, in general, clothing that can compromise personal safety.



All operations on the equipment must be performed with adequately insulated clothing and instruments.

E.g.: insulating gloves, class 0, RC category

Maintenance operations may only be performed after the equipment has been disconnected from the grid and from the photovoltaic generator.

Staff must NOT go near the equipment with bare feet or wet hands.

The maintenance technician must in any case ensure that no one else can switch on or operate the equipment during the maintenance operations, and should report any anomaly or damage due to wear or ageing so that the correct safety conditions can be restored.

The installer or maintenance technician must always pay attention to the work environment, ensuring that it is well-lit and there is enough room to ensure an escape route.



During installation, **consider that the noise emitted based on the environment** could possibly exceed the legal thresholds (less than 80 dBA), therefore, suitable ear protection must be worn.

Residual risks



Despite the warnings and safety systems, there are still some residual risks that cannot be eliminated.

These risks are listed on the following table with some suggestions to prevent them.

Table: residual risks

RISK ANALYSIS AND DESCRIPTION	SUGGESTED REMEDY
Noise pollution due to installation in unsuitable environments or where personnel work permanently.	Reassess the environment or the spot for installation.
Unsuitable local ventilation that causes overheating of the equipment and sufficient ventilation so as not to create discomfort to people in the room.	Restore suitable ambient conditions and ventilate the room.
External weather conditions, such as water seepage, low temperatures, high humidity, etc.	Maintain ambient conditions suitable for the system.
Overheating of surfaces at high temperatures (transformers, accumulators, coils, etc.) can cause burns. Pay particular attention not to block any of the device's cooling slats or systems.	Use suitable protective equipment or wait for the parts to cool down before switching the equipment on.
Inadequate cleaning: jeopardises cooling and prevents reading of the safety labels.	Clean the device, the labels and the work environment adequately.
Accumulation of electrostatic energy can generate hazardous discharges.	Ensure the devices have discharged their energy before working on them.
Inadequate training of staff.	Ask for a supplementary course.
During installation, the provisional mounting of the equipment or its components may pose safety risks	Carefully monitor and restrict access to the installation area.
Accidental disconnections of the quick-fit connectors with the equipment in operation, or wrong connections, may generate electric arcs	Carefully monitor and restrict access to the installation area.



Lifting and transport

4

General conditions

Some indications are only valid for large sized products or packages containing multiple small sized products.

Transport and handling

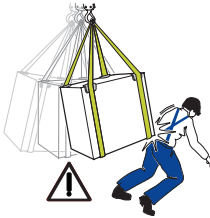

Transport of the equipment, especially by road, must be carried out by suitable ways and means for protecting the components (particularly electronic components) from violent shocks, humidity, vibrations, etc. **During handling, do not make any sudden or fast movements that could generate dangerous swinging.**

Lifting



ABB usually stores and protects individual components by suitable means to make their transport and subsequent handling easier. Nonetheless, as a rule, it is necessary to turn to the experience of specialised staff to take charge of loading and unloading components. Where indicated and/or available, eyebolts or handles, which can be used as anchorage points, are inserted and/or can be inserted.

The ropes and means used for lifting must be suitable for bearing the weight of the equipment.

Do not lift several units or parts of the equipment at the same time unless otherwise indicated.

Unpacking and checking

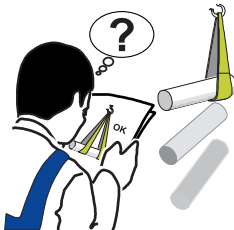
Bear in mind that the packaging elements (cardboard, cellophane, staples, adhesive tape, straps, etc.) may cause cuts and/or injuries if not handled with care. They should be removed by suitable means and not left in the hands of individuals who are not responsible (e.g. children).

The packaging components must be disposed of in accordance with the regulations in force in the country of installation.

When you open the package, check that the equipment is undamaged and make sure all the components are present.

If any defect or damage is detected, please stop, contact the carrier and also promptly inform the **ABB** Service Department.

List of components supplied

All the components required to correctly install and connect the inverter are supplied together with the inverter.

Available components	Quantity
	Bracket for wall mounting 1
	Plug, screws and washer for wall mounting 2 + 2 + 2
	M5x10 screw and M5 washer to lock bracket 2 + 2
	M5x10 screw and M5 contact washer for external ground connection 1 + 2
	Two-hole gasket for M20 service cable gland and TGM58 cover 1 + 1
	Airtight connector for AC cable connection 1
	Airtight connector for RS485 serial cable connection 1
	TORX TX25 L-key 1
	Technical documentation 1



Weight of the modules of the equipment

Table: Weights	Weight (Kg/lb)	Lifting points (no.#)
UNO-2.0/3.0-TL-OUTD	12 kg / 26.4 lb	2
UNO-3.6/4.2-TL-OUTD	12 kg / 26.4 lb	2

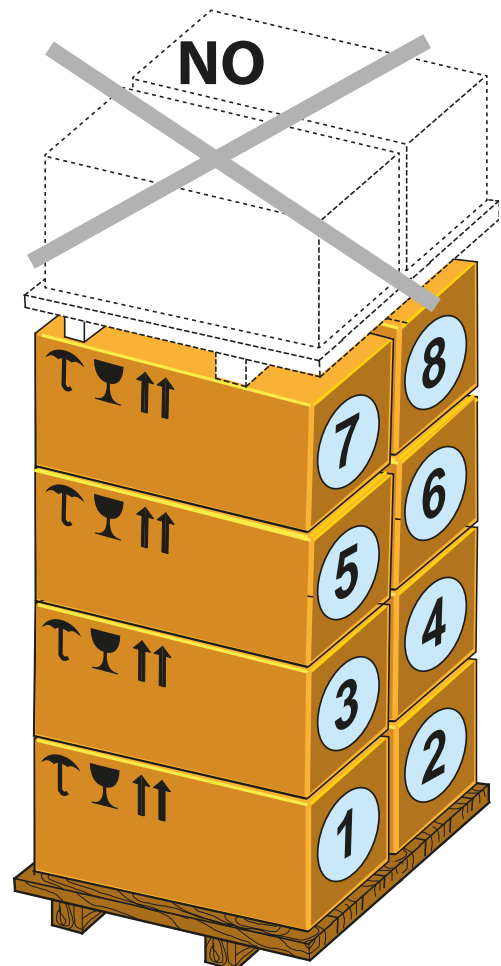

General conditions

The equipment is installed depending on the system and the place where it is installed. Its performance therefore depends on the correctness of the connections.

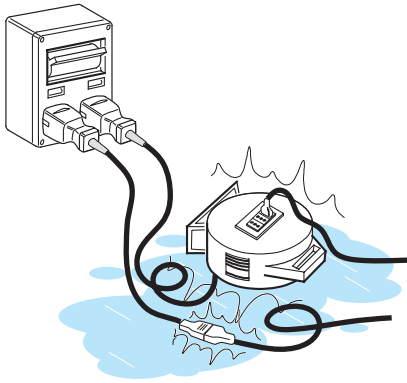

Staff authorised to carry out the installation must be specialised and experienced in this job; they must also have received suitable training on equipment of this type.

The operation must be carried out by qualified personnel and it is advisable to adhere to the indications provided in this manual, the diagrams and the enclosed documentation.



For safety reasons, only a qualified electrician who has received training and/or demonstrated skills and knowledge on the structure and operation of the unit may install the inverter.



The installation must be performed by qualified installers and/or licensed electricians in accordance with the existing regulations in the country of installation.



The removal of the inverter panels/covers allows access to the area dedicated to service personnel (the operator is not authorized to access this area)



Connection of the photovoltaic system to an electric installation connected to the distribution grid must be approved by the electricity provider.



The installation must be carried out with the equipment disconnected from the grid (power disconnect switch open) and with the photovoltaic panels shaded or isolated.



When the photovoltaic panels are exposed to sunlight they provide continuous DC voltage to the inverter.

Environmental checks

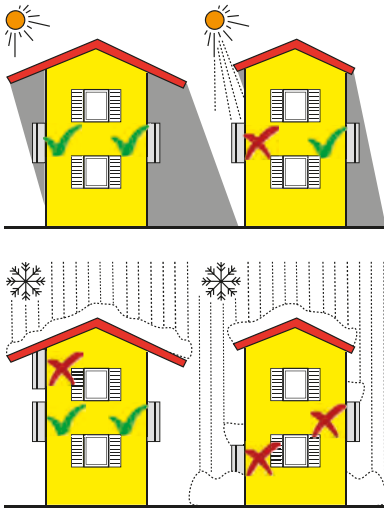

- Consult the technical data to check the required environmental conditions (protection rating, temperature, humidity, altitude, etc.)
- Installation of the unit in a location exposed to direct sunlight must be avoided (otherwise the warranty will be cancelled) as it may cause:
 - power limitation phenomena in the inverter (with a resulting decreased energy production by the system)
 - premature wear of the electrical/electromechanical components
 - premature wear of the mechanical components (gaskets) and of the user interface (display)
- Do not install in small closed rooms where air cannot circulate freely
- Always ensure that the flow of air around the inverter is not blocked so as to prevent overheating.
- Do not install near flammable substances (minimum distance 3 m)
- Do not install near walls made of wood or other flammable substances.
- Do not install in rooms where people live or where the prolonged presence of people or animals is expected, because of the high noise that the inverter produces during operation. The level of the sound emission is heavily influenced by where the inverter is installed (for example: the type of surface around the inverter, the general properties of the room, etc.) and the quality of the electricity supply.
- Avoid electromagnetic interference that can compromise the correct operation of electronic equipment, with the consequent hazards



Final installation of the equipment must not compromise access to any disconnection devices that may be located externally.

Please refer to the warranty terms and conditions to evaluate any possible warranty exclusions due to improper installation.

Installations above 2000 metres



On account of the rarefaction of the air (at high altitudes), particular conditions may occur that should be considered when choosing the place of installation:

- Less efficient cooling and therefore a greater likelihood of the device going into derating because of high internal temperatures.
 - Reduction in the dielectric resistance of the air which, in the presence of high operating voltages (DC input), can create electric arcs (electrical discharges) that may damage the equipment.
- As the altitude increases, the failure rate of some electronic components increases exponentially because of cosmic radiation.



All installations at altitudes of over 2000 metres must be assessed case by case considering the aforesaid criticalities.

Installation position

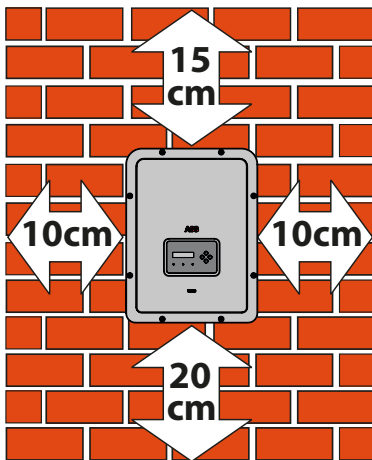
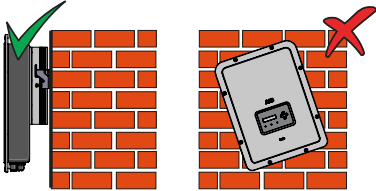
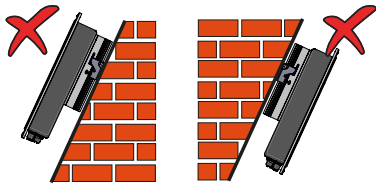

When choosing the place of installation, observe the following conditions:

- Install on a wall or strong structure suitable to bear the weight
- Install in safe, easy to reach locations
- If possible, install at eye-level so that the display and status LEDs can be seen easily
- Install at a height that considers the heaviness of the equipment. Failure to meet this condition could result in problems during servicing, unless suitable means are provided to carry out the operation
- Install vertically with a maximum inclination of 5° (forward or backward). If this condition cannot be met, the inverter could undergo derating due to high temperature because of poor heat dissipation.

- Maintenance on device hardware and software entails removing the front covers. Check that the correct installation safety distances are observed in order to allow routine check and maintenance operations.
- Comply with the minimum distances indicated

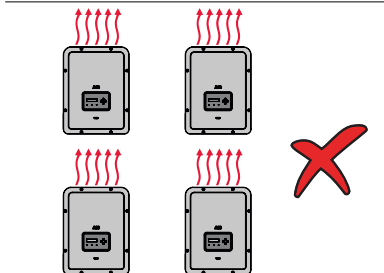
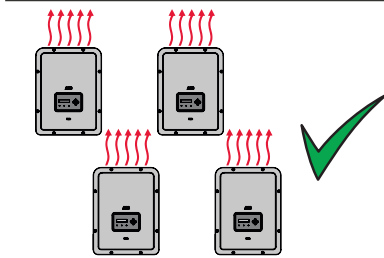
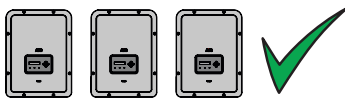

- For a multiple installation, position the inverters side by side.

- If the space available does not allow this arrangement, position the inverters in a staggered arrangement as shown in the figure so that heat dissipation is not affected by other inverters.

Wall mounting

During installation do not place the inverter with the front cover 05 facing the ground.

- Position the bracket 01 so that it is perfectly level on the wall and use it as a boring template.
- Make the 2 holes necessary using a drill with a 10 mm. diameter bit. The depth of the holes must be approximately 70 mm.
- Secure the bracket to the wall with the two 10 mm wall plugs supplied.
- Attach the inverter by inserting the two tabs on the bracket 01 into the 2 slots on the inverter (figures A1 and A2).
- Secure the inverter to the bracket by screwing the lock screws 02 on both sides of the inverter (figure A3).
- The main connections of the inverter are carried out externally without the need to remove the front cover. If necessary, unscrew the 8 screws and open the front cover 05.



Do not open the inverter in the case of rain, snow or a high level of humidity (>95%)

- Once the connections have been made inside the inverter, close the cover by tightening the 8 screws on the front, respecting the sequence and tightening torque (see specific paragraph on "Closing the front cover").

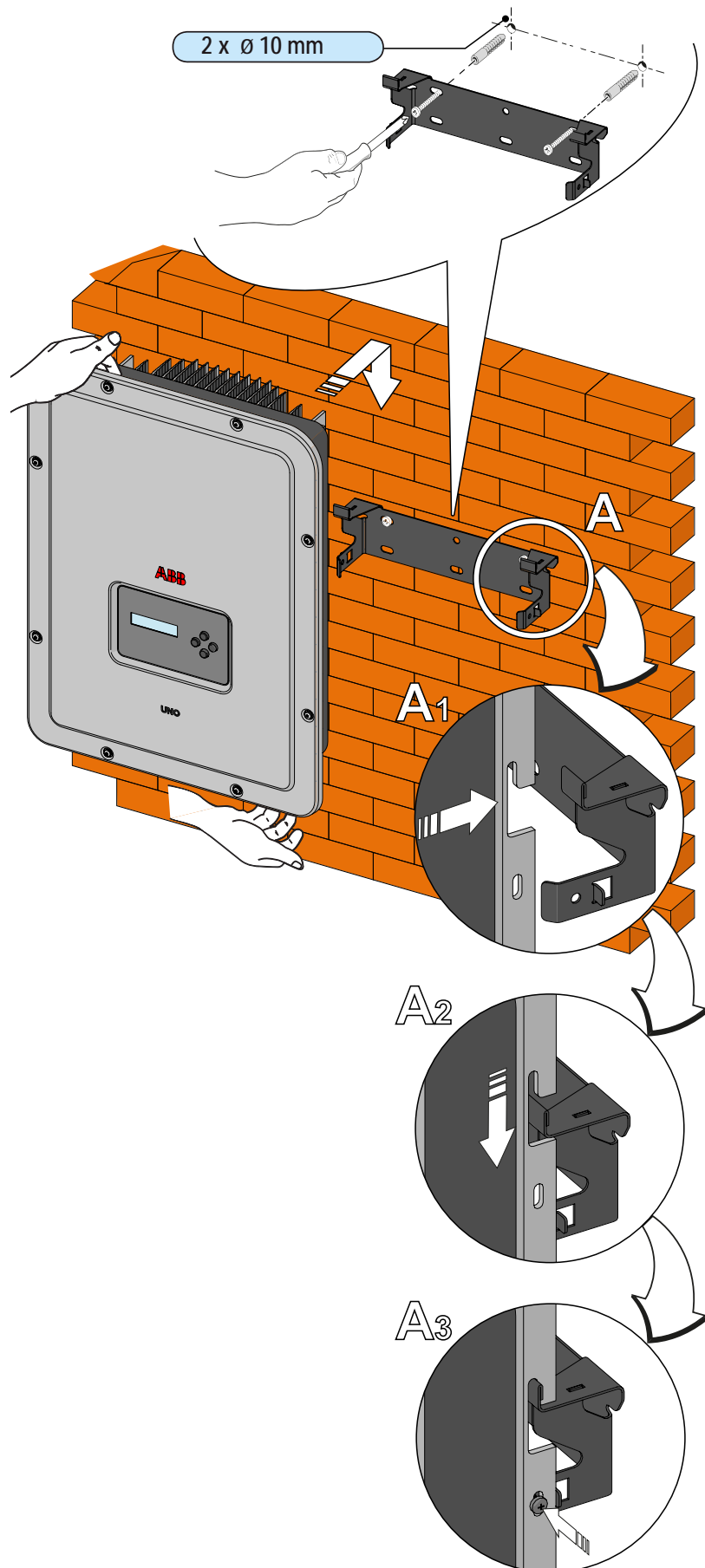

Preliminary operations for connection of the PV generator

Checking the correct polarity of the strings

Using a voltmeter, check that the voltage of each string has the correct polarity and falls within the input voltage limits of the inverter (see technical data).



Polarity inversion can cause serious damage.

If the open circuit voltage of the string is near the maximum value accepted by the inverter, consider that low ambient temperatures cause an increase in the string voltage (different according to the photovoltaic module used). In this case it is necessary to carry out a check of the sizing of the system and/or a check on the connections of the modules of the system (e.g.: number of modules in series higher than the design number).

Checking of leakage to ground of the photovoltaic generator



Measure the voltage present between the positive and negative pole of each string with respect to ground.

If a voltage is measured between an input pole and ground, it may be that there is a low insulation resistance of the photovoltaic generator and the installer will have to carry out a check to solve the problem.



Do not connect the strings if a leakage to ground has been detected, as the inverter might not connect to the grid.

Selection of differential protection downstream of the inverter

All ABB string inverters marketed in Europe are equipped with a device for protection against ground faults in accordance with the safety standard IEC 62109-2, sections 4.8.2 and 4.8.3 of the Standard (equivalent to Standard DIN V VDE V 0126-1:2006, section 4.7). In particular, ABB inverters are equipped with a redundancy on the reading of the ground leakage current sensitive to all components of both direct and alternating current. Measurement of the ground leakage current is carried out at the same time and independently by 2 different processors: it is sufficient for one of the two to detect an anomaly to trip the protection, with consequent disconnection from the grid and stopping of the conversion process. There is an absolute threshold of 300 mA of total leakage current AC+DC with protection tripping time at a max. of 300 msec.

In addition, there are another three tripping levels with thresholds respectively at 30 mA/sec, 60 mA/sec and 150 mA/sec to cover the “rapid” changes in fault current induced by accidental contact with leaking live parts. The max. tripping times are progressively shortened as the speed of change in the fault current increases and, starting from the 300 msec/max for the 30 mA/sec change, they are shortened respectively to 150 msec and 40 msec for 60 mA and 150 mA changes.

It should in any case be noted that the integrated device only protects the system against ground faults that occur upstream of the AC terminals of the inverter (namely towards the DC side of the photovoltaic system and consequently towards the photovoltaic modules). The leakage currents that can occur in the AC section between the draw/feed and the inverter are not detected and require an external protection device.

For protection of the AC line, on the basis of the information above with regard to the differential protection integrated in **ABB** inverters, **it is not necessary to install a type B differential switch.**

In accordance with article 712.413.1.1.1.2 of Section 712 of IEC Standard 64-8/7, we hereby declare that, because of their construction, ABB inverters do not inject ground fault direct currents.



The use of an AC type circuit breaker with differential thermal magnetic protection with tripping current of 300 mA is advisable so as to prevent false tripping, due to the normal capacitive leakage current of photovoltaic modules.



In the case of systems which consist of several inverters connected to a single switch with differential protection it is recommended that a device is installed which allows the adjustment of the tripping value and the tripping time.

Input connection to PV generator (DC side)

After having carried out preliminary checks and therefore having verified that there are no problems in the photovoltaic system, the inputs can be connected to the inverter.



When the photovoltaic panels are exposed to sunlight they provide continuous DC voltage to the inverter. To avoid risks of electric shock, all wiring operations must be carried out with the DC disconnect switch (**internal or external to the inverter**) off.



Caution! The inverters referred to in this document are TRANSFORMERLESS. This type requires the use of insulated photovoltaic panels (IEC61730 Class A Rating) and the need to keep the photovoltaic generator floating with respect to ground: no terminal of the generator must be connected to ground.

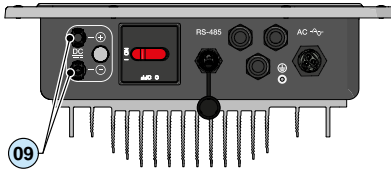

The inverter has a single input channel (MPPT) and is equipped with a pair of quick-fit connectors 09 for connecting the PV generator.



If the input strings are connected in parallel, they must have the same installation conditions (number of panels in series, type of panels, orientation and angle).



Comply with the maximum input current relating to the quick-fit connectors as indicated in the technical data.



Polarity inversion can cause serious damage. Check polarity before connecting each string!

Insert the quick-fit connectors always checking the tightness of the connectors.

The figure below shows a connection example of the string inputs.

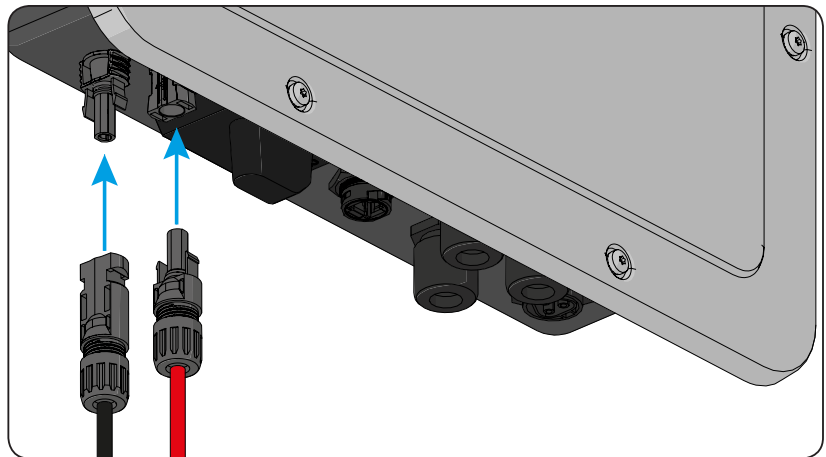

Installation procedure for quick-fit connectors

There are typically four different types of quick-fit connector models used on ABB inverters: Weidmüller PV-Stick or WM4, MultiContact MC4 and Amphenol H4.

Please refer to the document “*String inverters – Product manual appendix*” available at www.abb.com/solarinverters for information on the quick-fit connector brand and model used in the inverter.

The model of connectors installed on your inverter must be matched by the same model of the respective corresponding parts to be used (checking the conforming corresponding part on the manufacturer's website or with ABB).



Using corresponding parts that are not compliant with the quick-fit connector models on the inverter could cause serious damage to the unit and lead to invalidation of the warranty.



CAUTION: To avoid damage to the equipment, when attaching cables, pay particular attention to polarity.



1. WEIDMÜLLER PV-Stick quick-fit connectors

Installation of Weidmüller PV-Stick connectors does not require any special tooling.

- Strip the cable to which you want to apply the connector (after verifying that it complies with the connector limits).

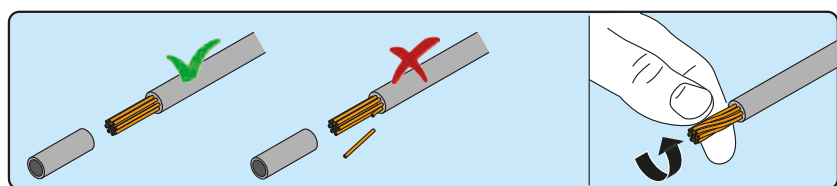
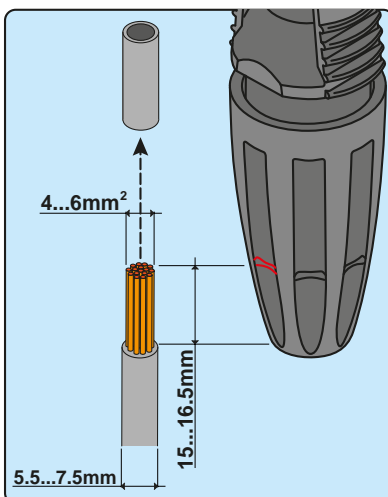

- Insert the wire into the connector until you hear a locking "click".

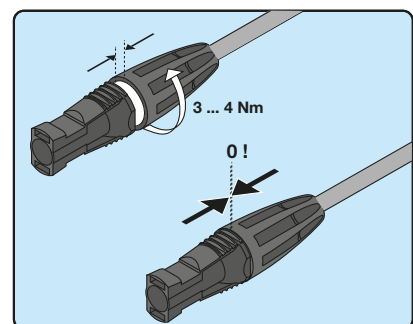
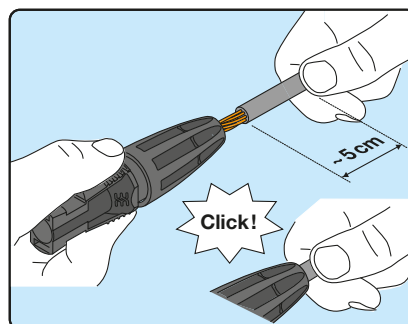

- Tighten the knurled ring nut for optimal clamping.

2. WEIDMÜLLER WM4 quick-fit connectors

Installation of Weidmüller WM4 connectors requires crimping to be carried out with suitable equipment.

- Strip the cable to which you want to apply the connector (after verifying that it complies with the connector limits).

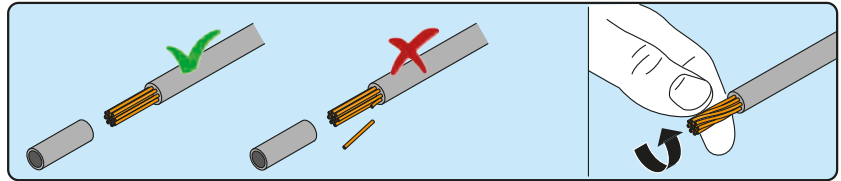
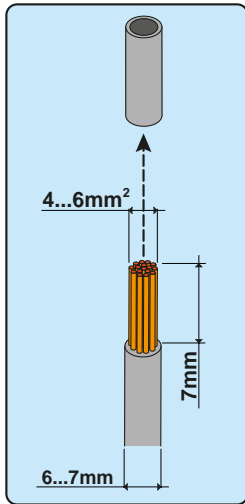

- Apply the terminal to the conductor using the designated pliers.

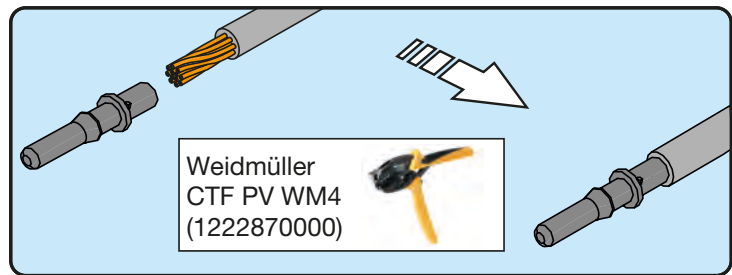

- Insert the cable with the terminal into the connector, until you hear the click indicating that the terminal is locked inside the connector.

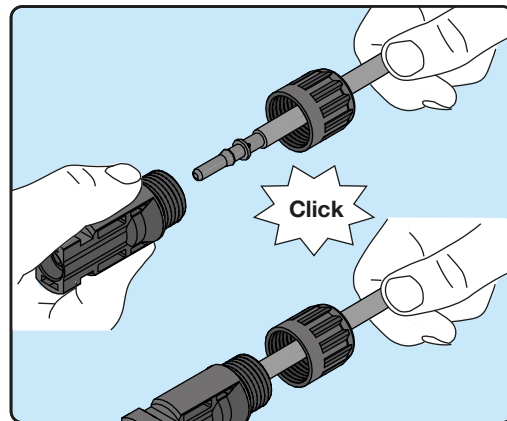

- Firmly tighten the cable gland using the relevant tool to finish the operation.

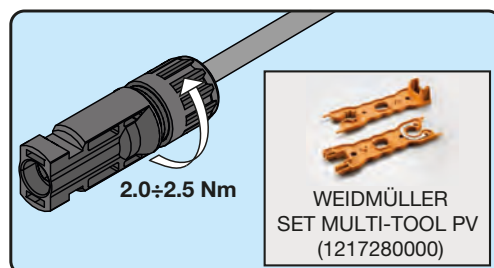

3. MULTICONTACT MC4 quick-fit connectors

Installation of Multicontact MC4 connectors requires crimping to be carried out with suitable equipment.

- Strip the cable to which you want to apply the connector (after verifying that it complies with the connector limits).

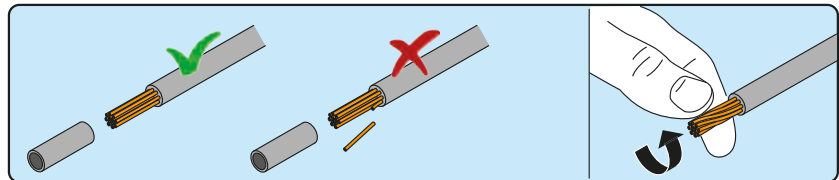
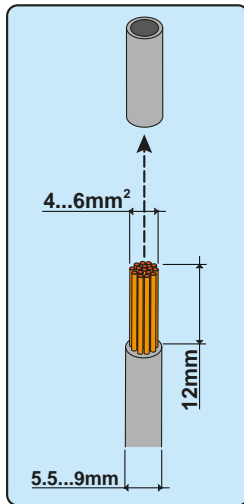

- Apply the terminal to the conductor using the designated pliers.

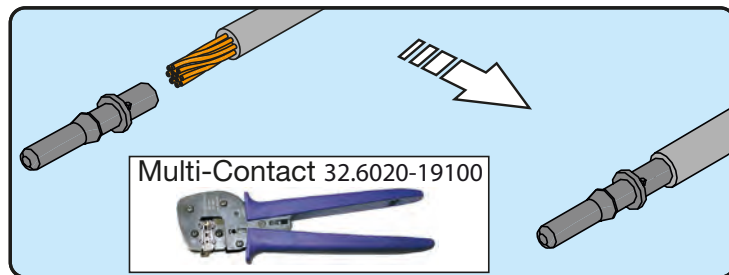

- Insert the cable with the terminal into the connector, until you hear the click indicating that the terminal is locked inside the connector.

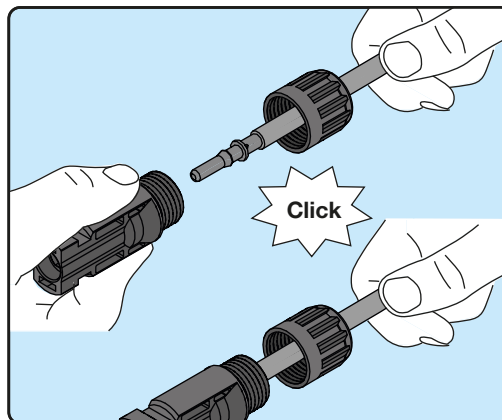

- Firmly tighten the cable gland using the relevant tool to finish the operation.

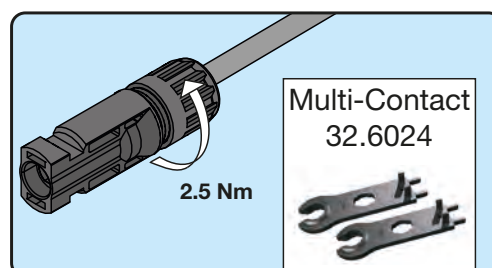

4. AMPHENOL H4 quick-fit connectors

Installation of Amphenol H4 connectors requires crimping to be carried out with suitable equipment.

- Strip the cable to which you want to apply the connector (after verifying that it complies with the connector limits).

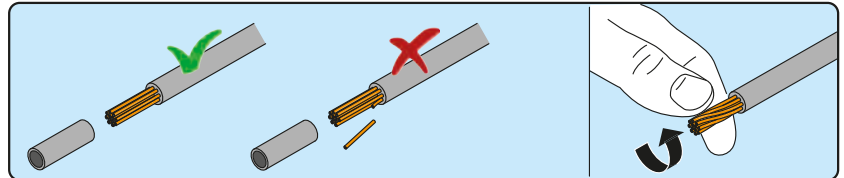
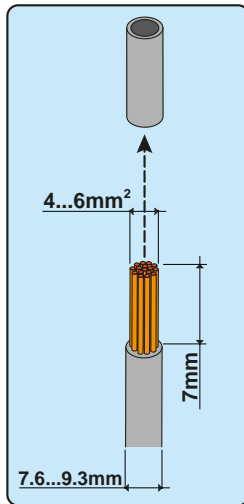

- Apply the terminal to the conductor using the designated pliers.

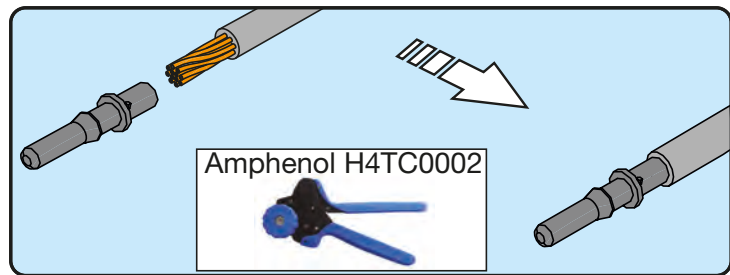

- Insert the cable with the terminal into the connector, until you hear the click indicating that the terminal is locked inside the connector.

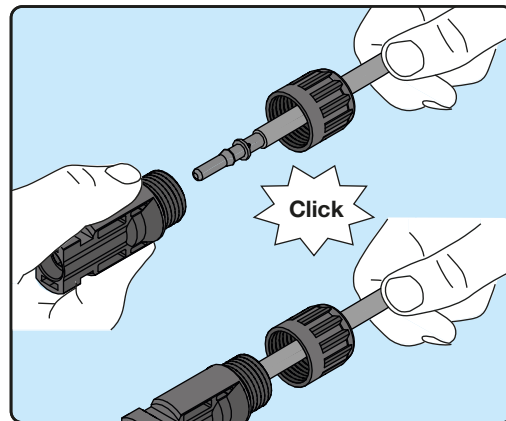

- Firmly tighten the cable gland using the relevant tool to finish the operation.

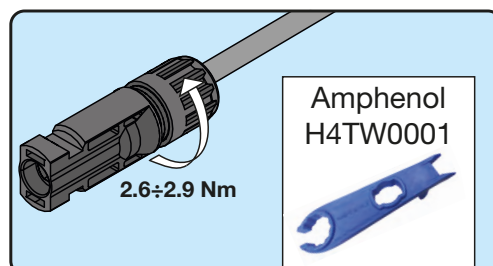

Distribution grid output connection (AC side)

To connect the inverter to the grid you need 4 connections: ground, neutral, phase and external grounding protection. **In any case, connection of the inverter to ground is mandatory.**



Any failure of the inverter when it is not connected to ground through the appropriate terminal (AC connector) and to the metal frame (external grounding protection) is not covered by the warranty.

The connection of the grid cable to the inverter is realised through the dedicated AC output connector ⑩ by carrying out the following operations:

- Characteristics and sizing of the line cable
- Installation of the cable on the AC output connector ⑩
- Connection of the AC output connector to the inverter

Characteristics and sizing of the line cable

The cross-section of the AC line conductor must be sized in order to prevent unwanted disconnections of the inverter from the grid due to high impedance of the line that connects the inverter to the power supply; If the impedance is too high it causes an increase in the AC voltage which, on reaching the limit set by the standards in the country of installation, causes the inverter to switch off.

In order to allow installation of the grid cable inside the AC output connector ⑩, the sizings indicated in the figure must be observed

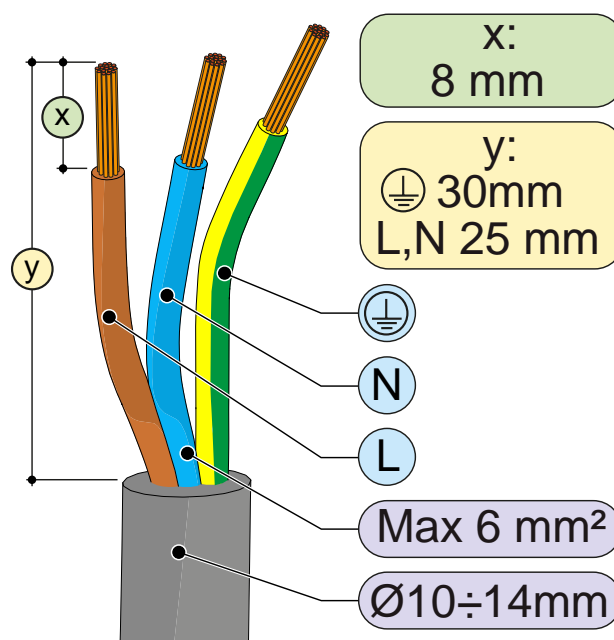

The table shows the maximum line conductor length in relation to the section of the conductor itself:

Line conductor cross section (mm ²)	Line conductor maximum length (m)			
	UNO-2.0	UNO-3.0	UNO-3.6	UNO-4.2
4	25 m	19 m	16 m	13 m
6	38 m	29 m	24 m	20 m



The values are calculated in nominal power conditions, considering:

- loss of power along the line no greater than 1%
- use of copper cable, with HEPR rubber insulation and positioned in open air

Load protection switch (AC disconnect switch)

To protect the inverter and the AC connection line, a device must be installed to protect against maximum current and leakage to ground, with the following characteristics:



	UNO-2.0	UNO-3.0	UNO-3.6	UNO-4.2
Type	Automatic circuit breaker with differential thermal-magnetic protection			
Voltage rating	230 Vac			
Current rating	16 A	20 A	20 A	25 A
Magnetic protection characteristic	B/C			
Differential protection type	A/AC			
Differential sensitivity	300 mA			
Number of poles	2			

Installation of the cable on the AC output connector

- Remove the head of the connector by pressing on the two holding clips and subsequently loosen the cable gland.

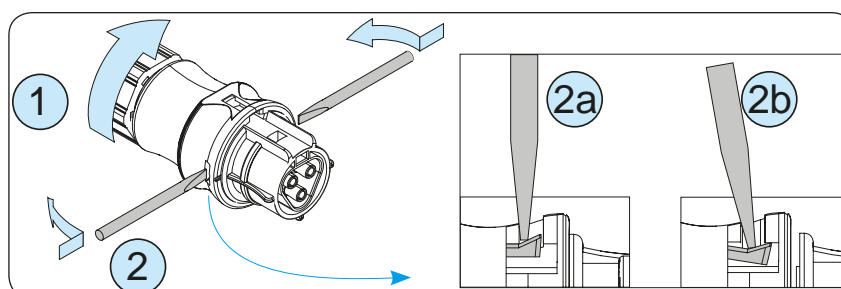

- Feed the cable through the connector and cut the cable to size

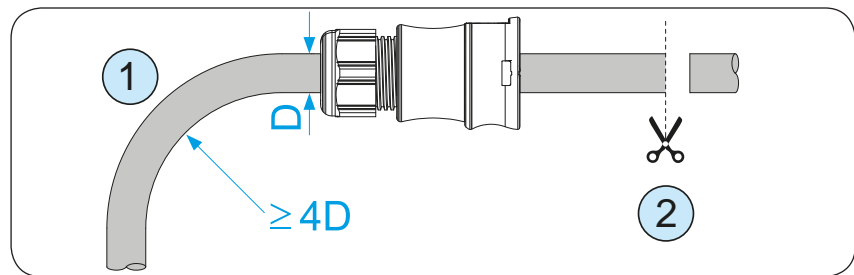

Ensure that the cable's radius of curvature is more than 4 times the diameter of the cable

- Prepare the cable respecting the following measurements.

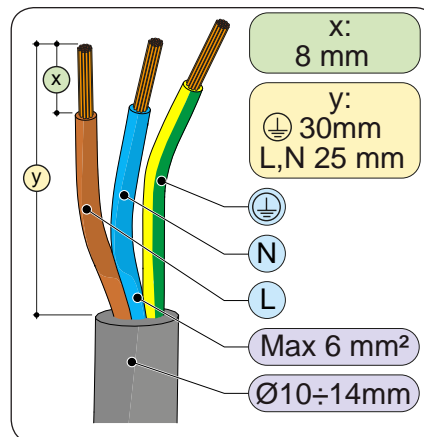

- Install the single wires (phase, neutral and ground) on the head of the connector respecting the indications printed on each of the three connection terminals (tightening torque 0.8...1Nm)

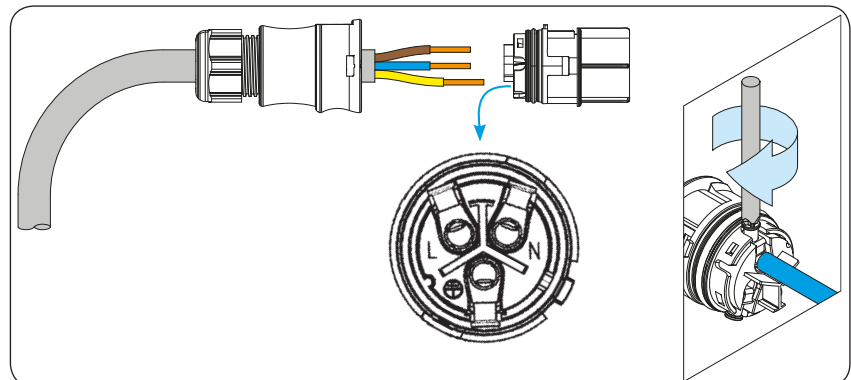

- Close the connector and tighten the cable gland respecting the tightening torque (4+1Nm) in order to guarantee the IP65 protection level

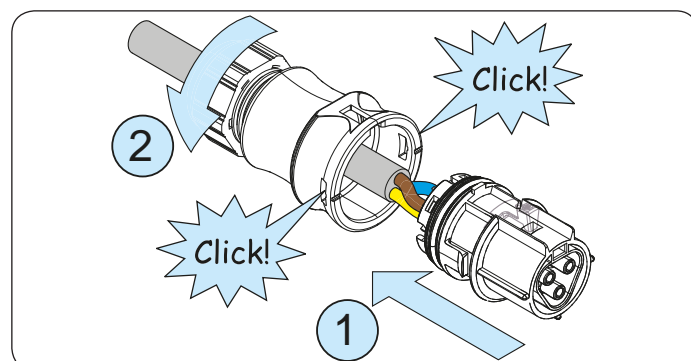

Connection for the AC output connector to the inverter



To avoid risks of electrical shock, all wiring operations must be carried out with the disconnect switch downstream of the inverter (grid side) off.

For all inverter models, connection to the electrical grid is carried out using the AC output connector ⑩.

- Remove the pre-installed protective cover on the inverter.
- Insert the corresponding part in the AC output connector ⑩ being careful to align the reference points (present on both connectors) which prevent connection errors.

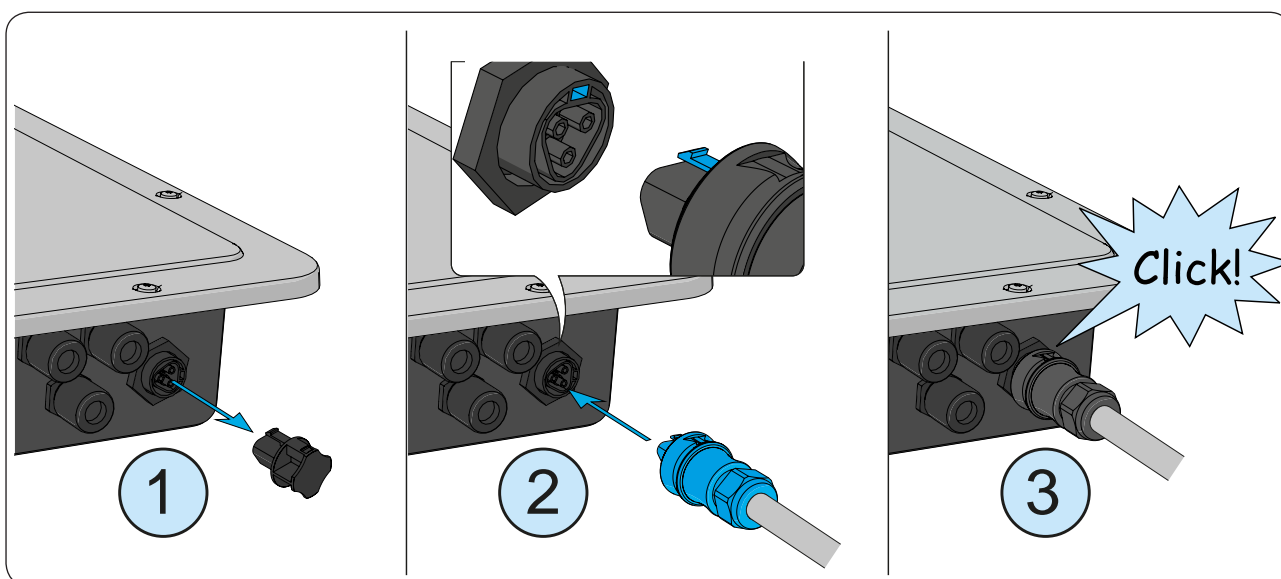

IP65

In order to maintain the inverter's level of IP protection, the corresponding part must be installed with the AC cable connected or the protective cover, on the AC output connector. In addition, the connector must not be subject to tensile forces (examples: do not connect weights to the AC cable, do not leave excess cable windings hanging, etc).

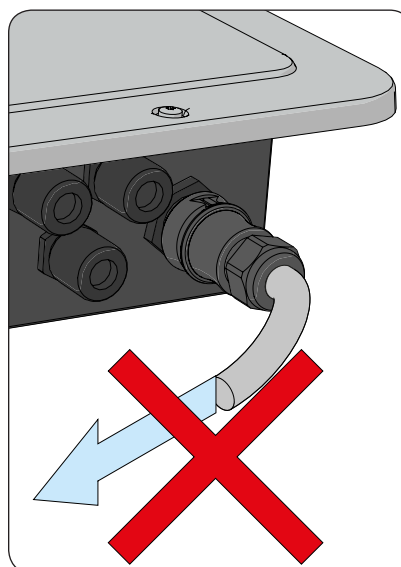

Installation of the external protective grounding cable

In addition to the grounding protection previously connected to the AC output connector, a second protective grounding cable has to be installed to be connected to the metal frame of the inverter.

The cable to be used must be copper and have a minimum cross-section not less than the phase cable and in any case not less than 4mm².

To install a second protective grounding cable, follow the procedure described below:

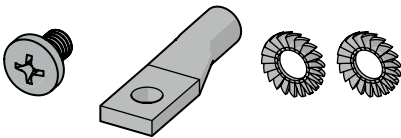

- From among the components supplied, find the M5 screw, the two knurled washers and the cable lug

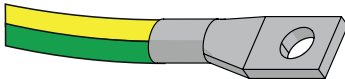

- Fit the cable lug on the protective grounding cable. The cable lug accepts cables with a cross-section of 4 to 6 mm²



- Fasten the cable lug using the screw and the two washers, following the sequence illustrated below and tightening to a torque of 4.1 Nm. The connection point is located on the underside of the inverter.

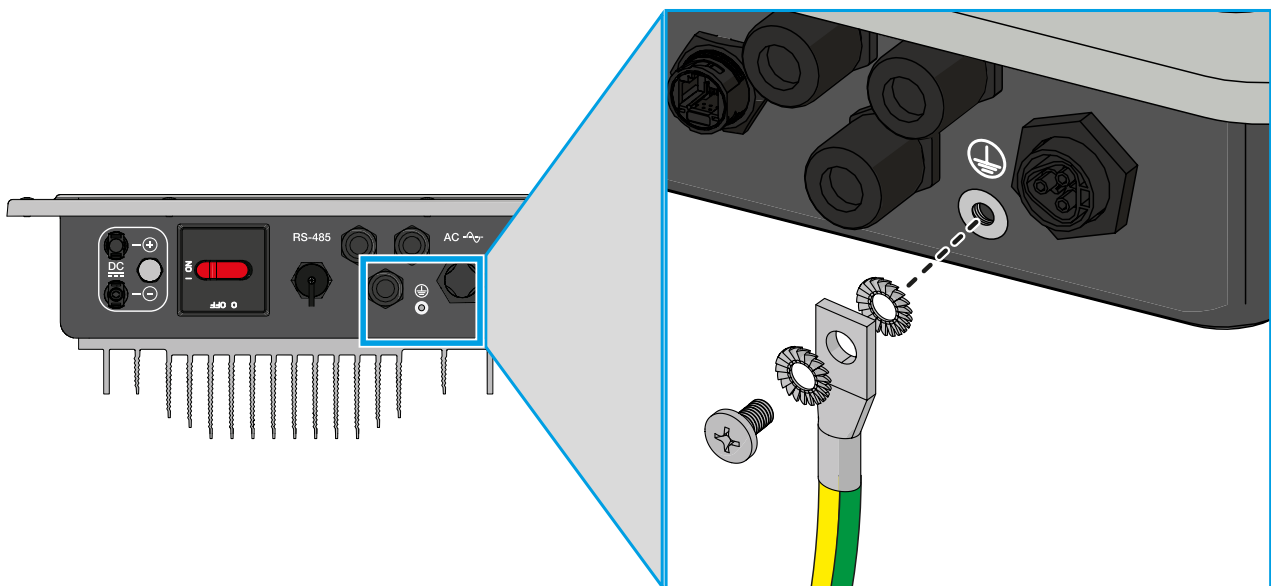

Connection of the RS485 communication signals

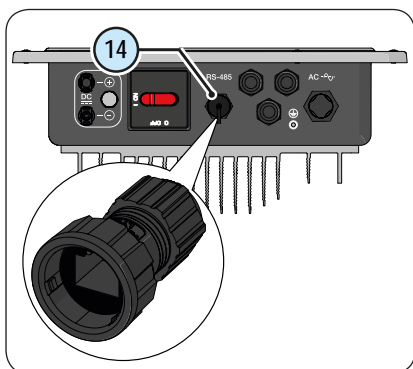

On the inverter there is an RS485 communication line, dedicated to connecting the inverter to monitoring devices. The line may also be used to store settings with the dedicated advanced configuration software. The connection of the serial communication cable must be made to the specific RS485 connector (14) present on the lower side of the inverter. An RJ45 connector must be installed on the cable and the connector in turn must be housed in the specific corresponding part (provided) which allows the level of IP protection of the inverter to be maintained.

Preparation of the RS485 cable

The RS485 cable must be installed on the corresponding part supplied which allows connection of the communication line with the inverter.

1. Install the blocking ring nut on the connector body
2. Install the gasket inside the connector body
3. Feed the cable through the holding ring nut and the connector body
4. Install the RJ45 connector on the cable and push it inside the connector body until it fits snugly
5. Insert the gasket through the RJ45 connector and position it until snug on the connector body
6. Extract the cable from the corresponding part just enough to enable the connection in the connector on the inverter.

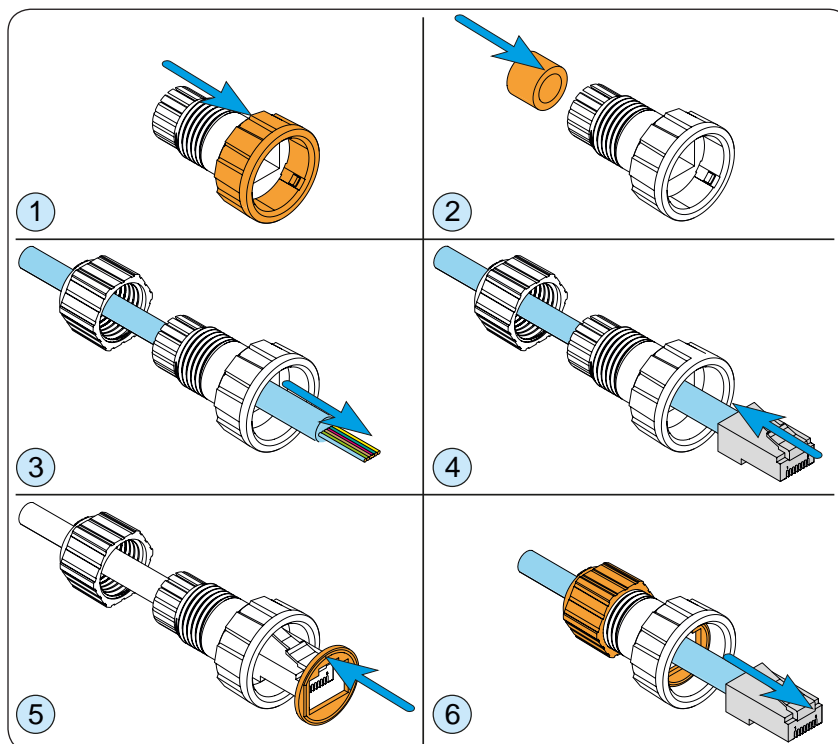

Once the cable has been prepared, it is possible to proceed with connecting the communication line to the inverter.

RS485 cable installation:

The connection of the RS485 serial communication cable must be made to the specific RS485 connector ⑭ present on the lower side of the inverter as follows:

- 1a. Install the cable on the RS485 connector on the inverter.
- 1b. Slide the corresponding part on the cable until bringing it snug to the RS485 connector of the inverter. Insertion of the corresponding part is guided by reference points which enable its correct positioning.
- 2a. Turn the fastening ring nut until blocking the two connectors and check the correctness of the installation.
- 2b. Turn the holding ring nut to a tightening torque of 0.6-0.8Nm

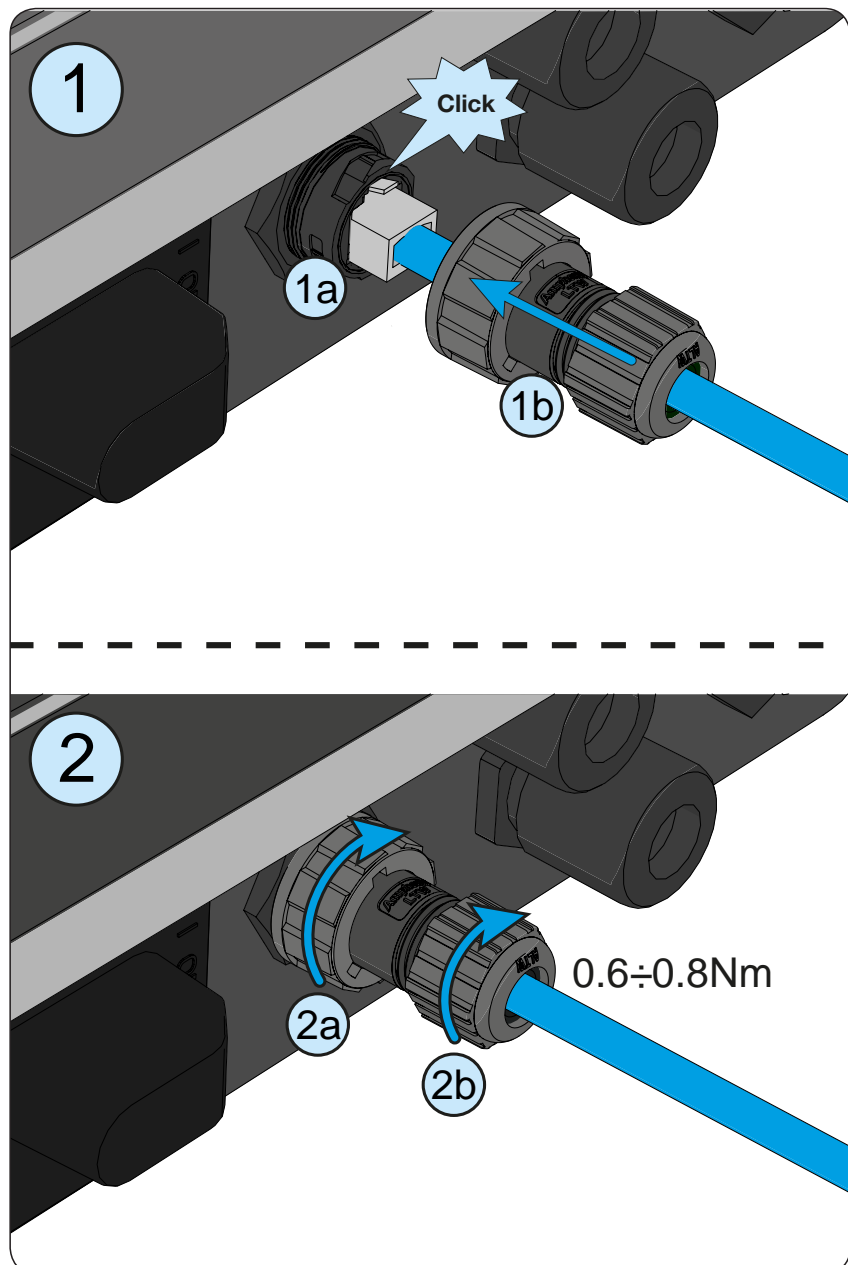

Connection of the RS485 line to a monitoring system

The RS485 communication line can be used for:

1. Connection of a signal converter allowing a computer to be connected in order to carry out the settings on the inverter using the advanced configuration software.

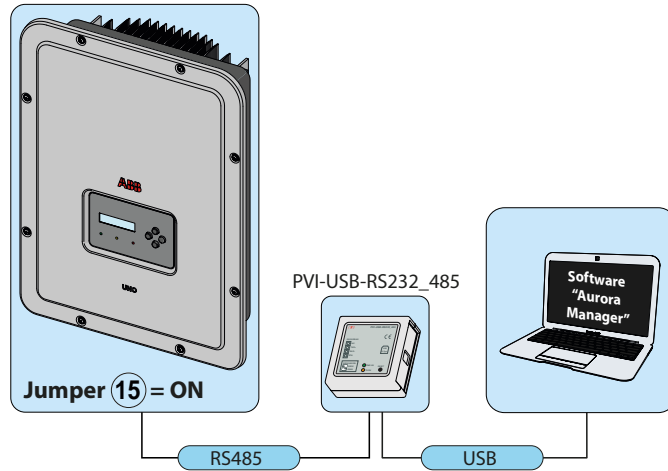

2. Connection of a monitoring device.

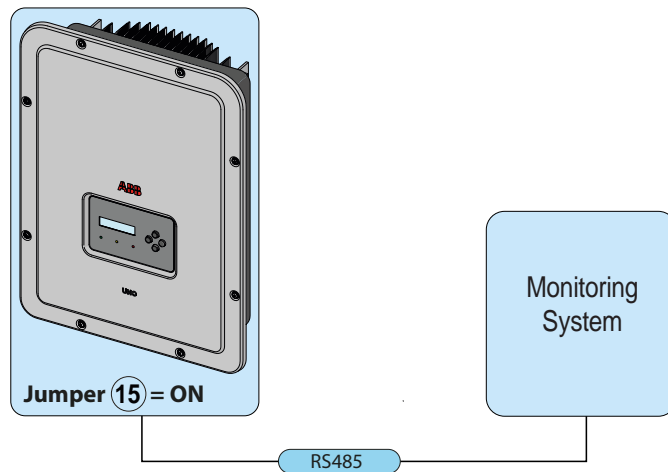

The RS485 communication line of the inverter can be configured to communicate with the ABB proprietary protocol (known as "Aurora") or with the Modbus public protocol by intervening on the inverter display.

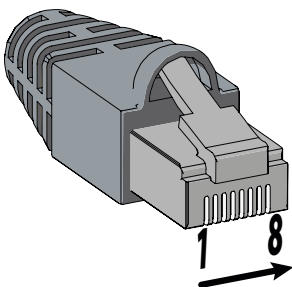

In both cases, the pin configuration for the connection of external devices must be respected:

Below is the pin configuration of the RJ45 connector.

Pin No.	Function
3	+T/R
5	-T/R
7	RTN
1, 2, 4, 6, 8	not used



It is recommended not to exceed a length of 1000m for the communication line. Use a connector with metal body to provide cable shield continuity!

For long distance connections, the connection on the terminal connector is preferable using a shielded twisted pair cable with characteristic impedance of $Z_0=120$ Ohm like the one shown on the following table:

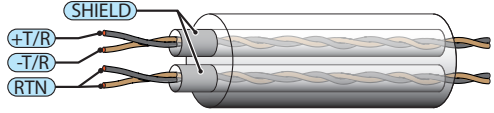
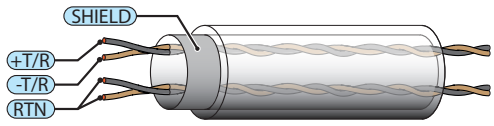
	Signal	Symbol
	Positive data	+T/R
	Negative data	-T/R
	Reference	RTN
	Screen	



Shield continuity must be provided along the communication line and must be grounded at a single point.

When the inverter has been connected to the monitoring system, the communication line terminating resistor has to be activated by setting the designated RS485 line termination jumper (15) to ON.

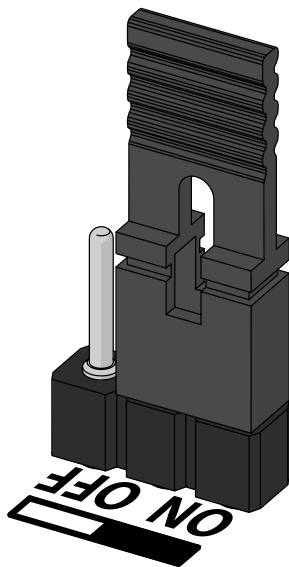

UNO-2.0/3.0-TL-OUTD-S

J25
ON OFF
120Ω
TERM.

UNO-3.6/4.2-TL-OUTD-S

J26
OFF ON
120Ω
ON TERM.

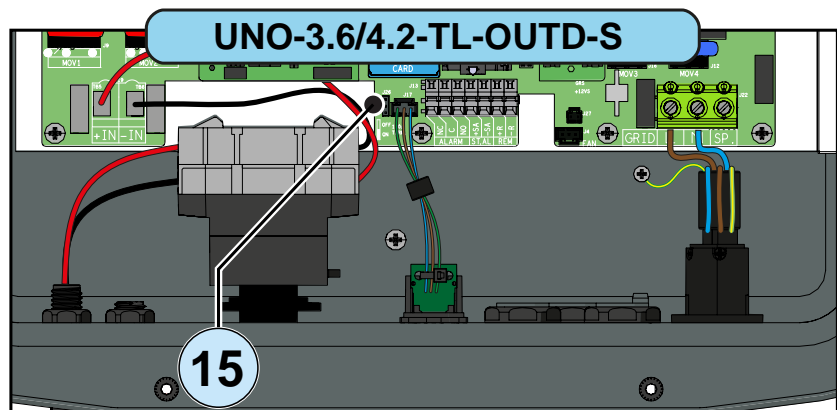
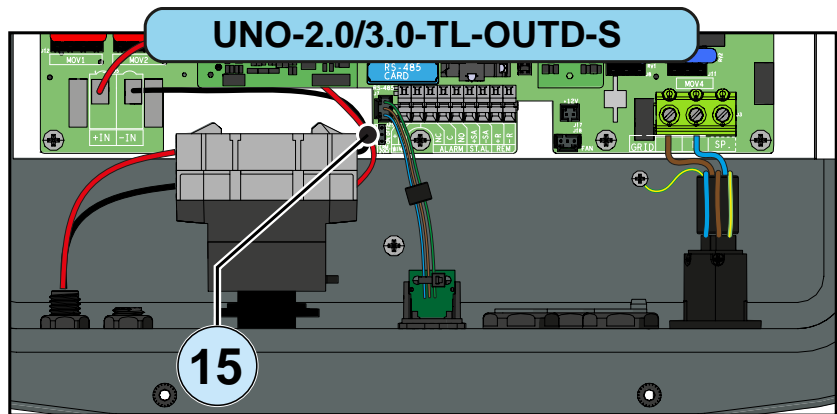

The inverter must not have “Auto” as an address. An address can be freely chosen between 2 and 63.

The setting of the address on the inverter is done through the display and the keyboard (see the specific chapter).

Each inverter is supplied with a preset RS485 address of two (2) and with the jumper for setting the termination resistance (15) in the OFF position.

Connection of the control signals

Connection of the control signals

- Remote ON/OFF
 - Enabling Stand-alone output
 - Multi-function relay
 - Tachometer signal (versions 2.0/3.0kW wind)
- must be done on the specific signal terminal block ⑬ inside the inverter using a flat screwdriver as shown in the figure:

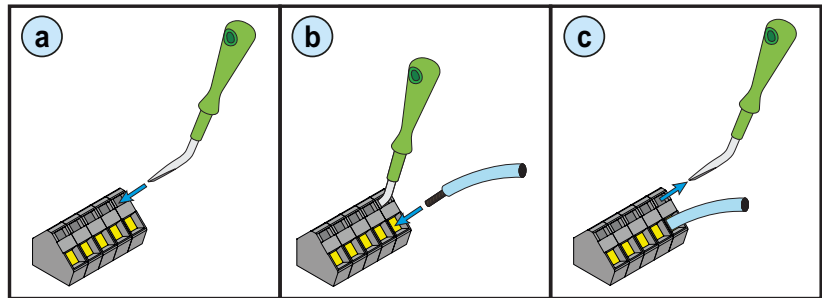

- Insert the screwdriver into the designated slot and press slightly, from top to bottom. Insert the screwdriver until the terminal opens.
- Insert the cable in the terminal.
- Remove the screwdriver and check that the cable is correctly inserted in the terminal.

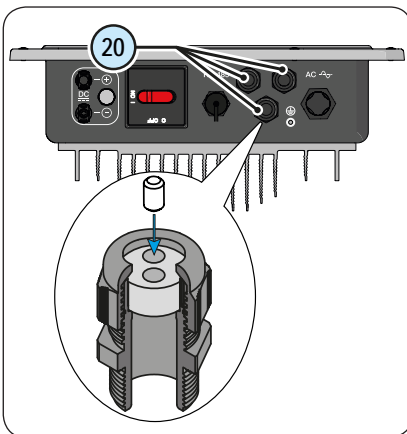

The control signal cables must pass through one of the three service cable glands ⑳.

Each M20 cable gland that accepts a cable with cross-section of between 7mm and 13mm.

Cable requirements

External diameter: from 5 to 13 mm

Conductor cross-section: from 0.14 to 1.5 mm²

Two-hole gaskets are supplied for insertion in the cable gland, which allow two separate cables with cross-section of up to 5 mm to pass through.

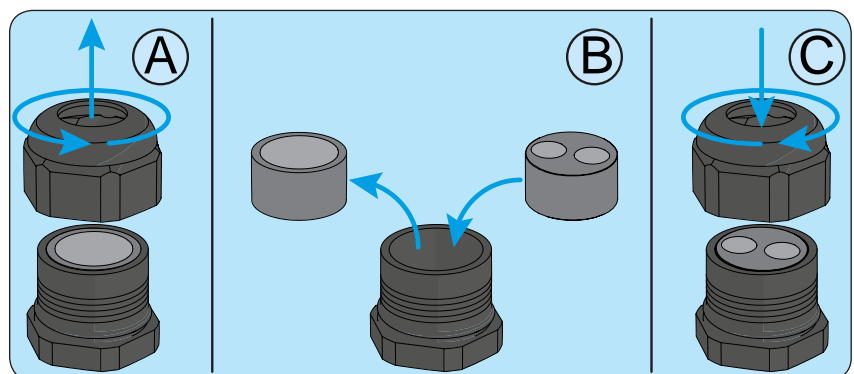

Remote control connection

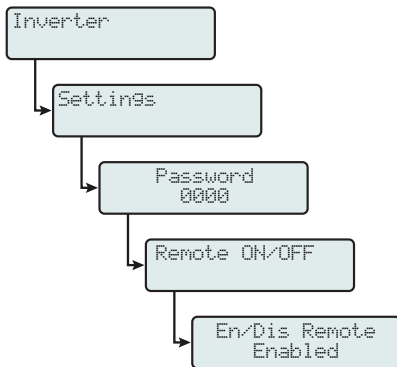

The connection and disconnection of the inverter to and from the grid can be controlled through an external control.

The function must be enabled in the specific menu. If the remote control function is disabled, the switching on of the inverter is dictated by the presence of the normal parameters that allow the inverter to connect to the grid.

If the remote control function is operating, besides being dictated by the presence of the normal parameters that allow the inverter to connect to the grid, start-up of the inverter also depends on the state of the terminal **R+** compared to the terminal **R-** present on the connector 13.

When the **R+** signal is brought to the same potential as the **R-** signal (that is to say when a short-circuit is created between the two connector terminals), the inverter is disconnected from the grid.

The remote control OFF condition is shown on the display.

Connections for this command are made between input “**R+**” e “**R-**”.

Since this is a digital input, there are no requirements to be observed as regards cable cross-section (it only needs to comply with the sizing requirement for passing cables through the cable glands and the terminal connector).

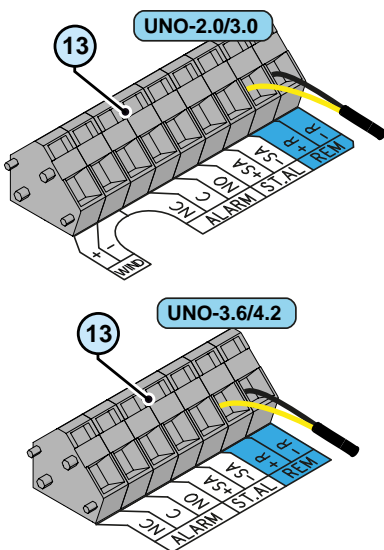

Connection enabling Stand-alone output

If the stand alone accessory board is installed on the inverter, it is able to convert the voltage from the photovoltaic generator even if there is no grid voltage (off grid operation).

In the event of an extended black-out, it is possible to manually enable the stand alone output to which a secondary emergency circuit can be connected.

Enabling the output is carried out by setting the +SA signal to the same potential as the -SA signal (i.e. creating a short-circuit between the two connector terminals).

Once the electrical power supply has been restored, the inverter will automatically disable the stand alone output returning to normal operation (connected to the electricity grid); in subsequent black-outs, it will once again be necessary to enable operation of the accessory board.

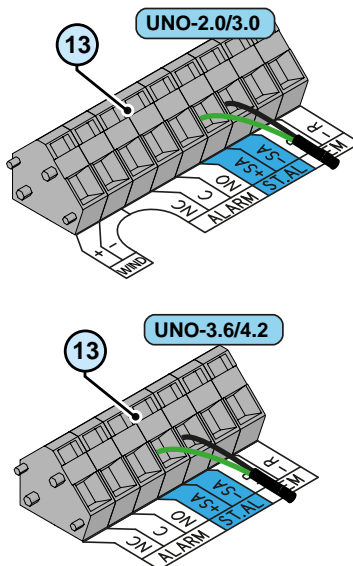

Configurable Relay connection (ALARM)

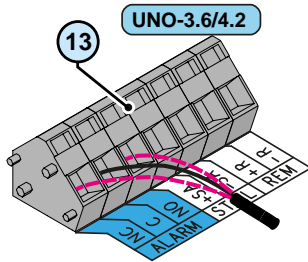
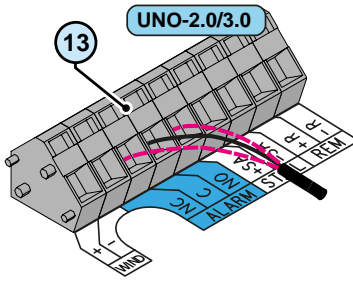

The inverter is equipped with a relay with configurable activation. It can be connected with normally open contact (being connected between the NO terminal and the common contact C) and with normally closed contact (being connected between the NC terminal and the common contact C).

Different types of devices (light, sound, etc.) can be connected to the relay, provided they comply with the following requirements:

Relay Rating:

Maximum Voltage: 24 Vdc / 12Vac
 Maximum Current: 1 A
 SELV

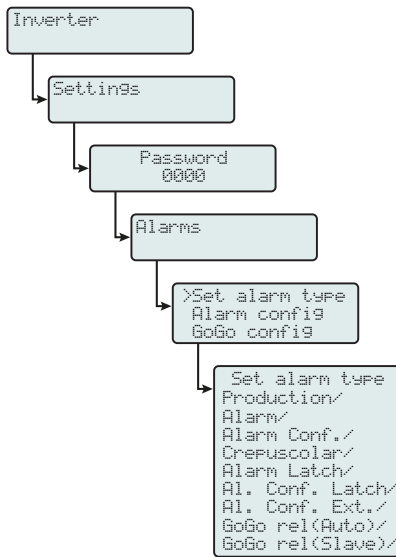
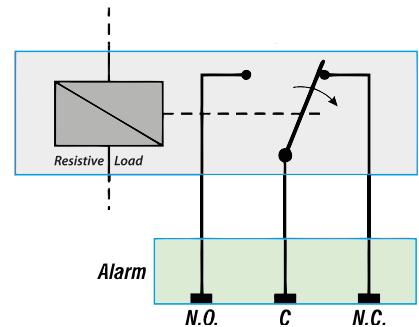

This contact can be used in different operating configurations that can be selected by accessing the dedicated menu.



The configurable relay contacts (ALARM) are not isolated from the accessible communication ports. Only connect sources which guarantee a voltage not exceeding 24Vdc/12Vac of safety SELV (Safety Extra Low Voltage).

Connector for the installation of expansion boards (optional)

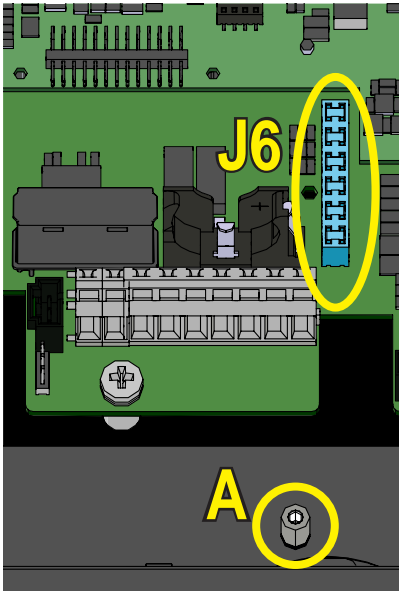

The inverter is provided with a connector (J6) used for the installation of expansion boards (optional).

The installation of an expansion board is made by inserting the terminals of the board in the connector J6.

During this phase check the correct insertion of the board because the misalignment of the terminals with respect to the connector may bring to the damage of the board, and/or of the inverter and as a consequence to the out of warranty.

Once the board has been inserted, it is needed to complete the installation by blocking the board to the chassis of the inverter with the dedicated fixing screw.

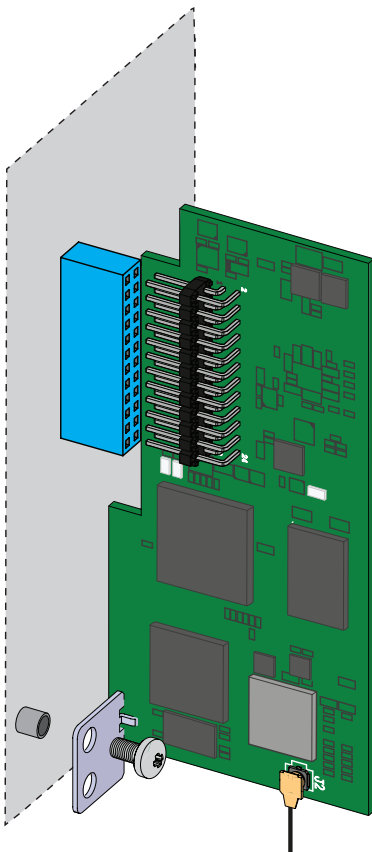

Closing the front cover

At the end of the inverter connection and configuration stage and before proceeding with the commissioning, the inverter's cover must be closed.

IP65

During the installation of the cover, the installation sequence must be respected as well as the tightening torque of the 8 screws (set out in the paragraph on technical data) in order to keep the IP level of the inverter unchanged

- Insert and screw in the 8 fixing screws.
- Tighten the screws respecting the sequence and the tightening torque.

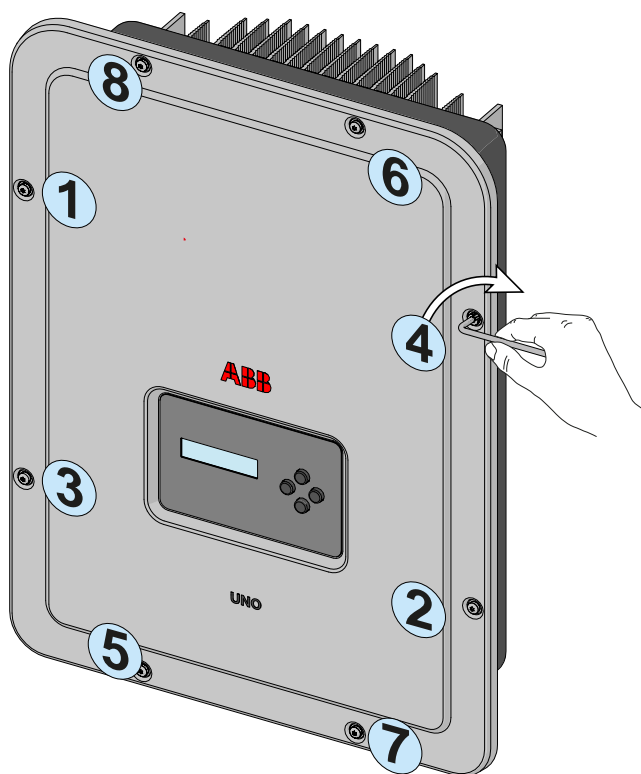

After having installed the front cover, it is possible to proceed with the commissioning of the inverter.

General conditions

One of the first rules for preventing damage to the equipment and operator is to have a thorough understanding of the INSTRUMENTS. We therefore advise you to read this manual carefully. If you are not sure about anything or there is discrepancy in information, please ask for more detailed information.



Do not use the equipment if:

- *you have insufficient qualifications to work on this equipment or similar products;*
- *you are unable to understand how it works;*
- *you are not sure what will happen when the buttons or switches are operated;*
- *you notice any operating anomalies;*
- *there are doubts or contradictions between your experience, the manual and/or other operators.*

ABB cannot be held responsible for damage to the equipment or the operator if it is the result of incompetence, insufficient qualifications or lack of training.

Description of keyboard and LED Panel

Using the combination of the keyboard keys below the display, values can be set or data can be viewed by scrolling.

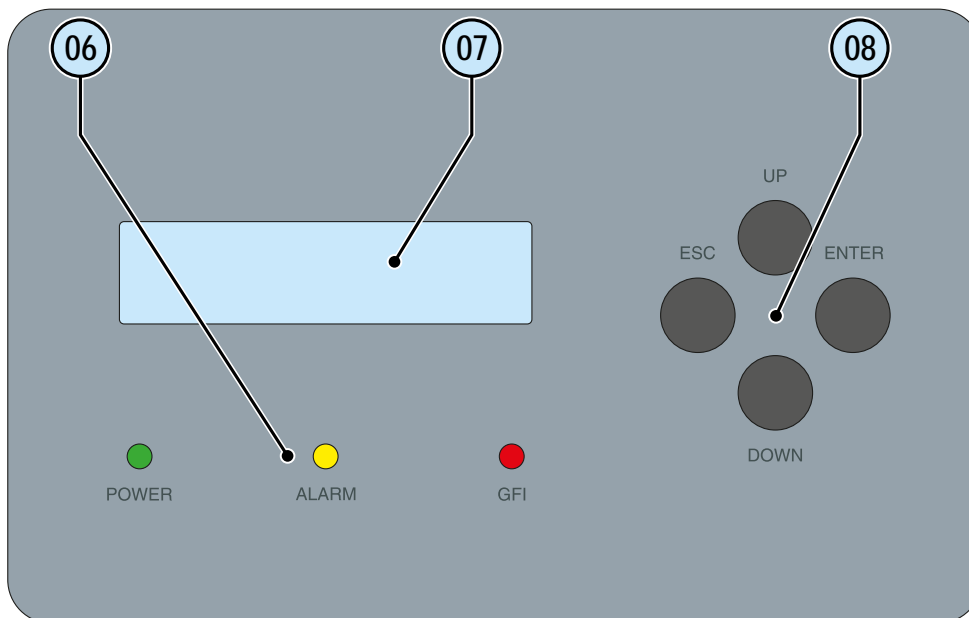

LED	Description
POWER (GREEN)	On if the inverter is working correctly. Flashes when checking the grid or if there is insufficient sunlight.
ALARM (YELLOW)	The inverter has detected an anomaly. The anomaly is shown on the display.
GFI (RED)	Ground fault on the DC side of the PV generator. The error is shown on the display.



The LEDs, in various multiple available combinations, can signal multiple conditions other than the original single condition; see the various descriptions explained in the manual.

Button	Description
ESC	It is used to access the main menu in order to go back to the previous menu or to go back to the previous digit to be edited.
UP	It is used to scroll up the menu options or to scroll through the numerical scale in ascending order.
DOWN	It is used to scroll down the menu options or to scroll through the numerical scale in descending order.
ENTER	It can be used to confirm an action, to access the main menu or the submenu for the selected option (indicated by the > symbol) or to switch to the next digit to be edited. When the ENTER key is pressed, cyclic display of the parameters can be: Blocked or Cyclical .

The Keys, in various multiple available combinations, allow you to access actions other than the original single action; see the various descriptions explained in the manual.

General conditions

Before checking the operation of the equipment, it is necessary to have a thorough understanding of the INSTRUMENTS chapter and the functions that have been enabled in the installation.

The equipment operates automatically without the aid of an operator; operating state is controlled through the instruments.



The interpretation or variation of some data is reserved exclusively for specialised and qualified staff.

The input voltage must not exceed the maximum values shown in the technical data sheet in order to prevent equipment from becoming damaged.

Consult the technical data for further details.

Even during operation, check that the environmental and logistic conditions are correct (see installation chapter).

Ensure that these conditions have not changed over time and that the equipment is not exposed to adverse weather conditions or isolated with foreign bodies.

Monitoring and data transmission

As a rule, the inverter operates automatically and does not require special checks. When there is not enough solar radiation to supply power for export to the grid (e.g. during the night), it disconnects automatically and goes into stand-by mode.

The operating cycle is automatically restored when there is sufficient solar radiation. At this point, the luminous LEDs on the LED panel will indicate this state.

User interface mode

The inverter is able to provide information about its operation through the following instruments:

- Warning lights (luminous LEDs)
- LCD display for displaying operating data
- Data transmission on the dedicated RS485 serial line. The data can be collected by a PC or a data logger equipped with an RS485 port. Contact the ABB support service with any queries about device compatibility.

Types of data available

The inverter provides two types of data, which can be retrieved through the special interface software and/or the display.

Real-time operating data

Real-time operating data can be transmitted on request through the communication lines and are not recorded in the inverter.



Internally stored data

The inverter internally stores a set of data that is necessary for processing statistical data and an error log with time marking.

Measurement tolerance

The data supplied by the inverter may differ from measurements taken by certified measuring instruments (e.g. output meters, multimeters and grid analysers); since the inverter is not a measuring instrument it has wider tolerances for the measurements it makes.

The tolerances are generally:

- ±5% for real-time measurements with output power below 20%
- ±3% for real-time measurements with output power above 20%
- ±4% for all statistical data.

Commissioning



Do not place objects of any kind on the inverter during operation! Do not touch the heat sink while the inverter is operating! Some parts may be very hot and could cause burns.



Before proceeding with commissioning, make sure you have carried out all the checks and verifications indicated in the section on preliminary checks.

The procedure for commissioning the inverter consists of the following steps:

- Close the DC disconnect switch to supply the inverter with the photovoltaic generator voltage.

If the inverter is equipped with a DC disconnect switch (-S models), set the DC disconnect switch  to the ON position.

```
Config. Wizard
ENTER to START
```

ENTER

```
Time hh:mm
Date DD MMM YYYY
```

ENTER

```
GRID=Xxxxxxxxxx
Lang=Xxxxxxxxxx
```

- When the inverter is connected to the power supply, the display will show a guided configuration procedure. Press ENTER to set the following:

- Inverter date and time

- Selection of grid standard and corresponding display language.



For the list of available grid standards and the relative details, contact ABB.



From the moment that the grid standard is set, you have 24 hours to make any changes to the value, after which the "Country Select > Set Std." functionality is blocked, and the remaining time will have to be reset in order to have the 24 hours of operation available again in which to select a new grid standard (follow the procedure "Resetting the remaining time for grid standard variation" described in the relevant section):

- After having set the Country Standard (grid standard), the message "Initializing...Please Wait" is displayed. Regardless of the input voltage value, the inverter displays various messages and changes the behaviour of the three LEDs .

Input voltage	Message on display	LED Status	Description
Vin < Vstart	Waiting Sun	Green = Flashing Yellow = OFF Red = OFF	The input voltage is not sufficient to enable connection to the grid.
Vin > Vstart	Missing Grid	Green = Flashing Yellow = ON Red = OFF	The input voltage is sufficient to enable connection to the grid: the inverter waits for the grid voltage to be present to make the parallel connection.



The inverter is powered SOLELY by the voltage generated by the photovoltaic generator: the presence of grid voltage alone is NOT SUFFICIENT for the inverter to switch on.

- With the inverter in the "Missing Grid" status, close the AC switch downstream of the inverter thus applying the grid voltage to the inverter: the inverter checks the grid voltage, measures the insulation resistance of the photovoltaic field with respect to ground and performs other auto-diagnostic checks. During the preliminary checks on the parallel connection with the grid, the green LED keeps flashing, the others are off.
- During the check on the grid voltage and the measurement of the insulation resistance, the voltage, grid frequency and insulation resistance values measured by the inverter are displayed. The inverter ONLY creates a parallel connection with the grid if the grid and insulation resistance parameters fall within the ranges foreseen by current regulations.
- If the outcome of the preliminary checks on the grid parallel is positive, the inverter connects to the grid and starts to export power to the grid. The green LED remains fixed on while the others are off.



To address any problems that may occur during the initial stages of operation of the system and to ensure the inverter remains fully functional, you are advised to check for any firmware updates in the download area of the website www.abb.com/solarinverters or at <https://registration.abbsolarinverters.com> (instructions for registering on the website and updating the firmware are given in this manual).



Firmware update

The firmware can be easily updated by means of a microSD Card (4GB maximum capacity).

The latest firmware version is available from the download area of the website www.abb.com/solarinverters or from <https://registration.abbsolarinverters.com>



Perform the update during good irradiation conditions (avoid the dawn and dusk hours)

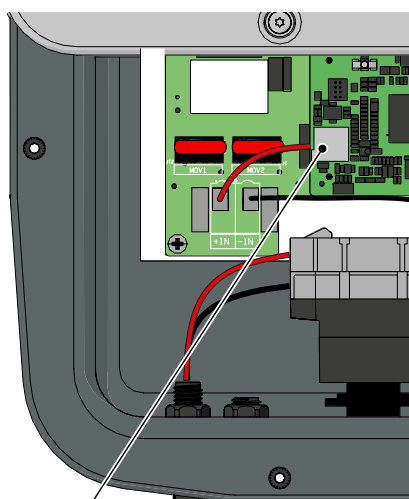

12

- Format the microSD card using a "FAT32" File System
- Save the (.tib) update file on the microSD Card. The file must not be compressed and/or nested inside folders
- Switch the inverter off by physically disconnecting the AC and DC side, as well as any voltages connected to the multi-function relay, then open the inverter front cover.
- Insert the microSD Card in the dedicated memory card slot 12
- Carry out the procedure for the commissioning of the inverter
- The inverter shows the "Update Available" message on the display.
 - Press ENTER
 - Select ">>START UPDATE" using the UP and DOWN keys
 - press ENTER to confirm the start of the firmware update process

Once the firmware update has been launched, no operations need to be carried out on the inverter as the 5 processes of the update will complete automatically.

- At the end, the message "Update COMPLETED" will appear on the display and by pressing any key, the result of the updates of the devices inside the inverter will be shown

Supervisor	OK
G. Settings	OK
Language	OK
DC/AC	OK
Safety	OK

The inverter firmware can be updated also by using the accessory boards. For further information, refer to the website or contact ABB.

Display access and settings

Once the inverter has been commissioned, it is possible to configure the inverter by accessing the "Settings" Menu directly from the display. The following are the main adjustable parameters (see the section on "**Menu descriptions**")

- **RS485 address:** setting required in the case of system monitoring via the RS485 line
- **Vstart:** setting required if requested by the configurator during the system sizing procedure ("Vstart" parameter)
- **MPPT scan:** allows maximum power point tracking to be carried out with settable sensitivity and time interval ("E/D MPPT Scan" parameter).
 - **Reactive power feed-in setting (where present):** setting necessary for managing the different ways of feeding reactive power into the grid ("Reactive Power" parameter)
 - **Active power limitation setting (where present):** setting necessary to set a limit on the active power supplied by the inverter ("Power Limit" parameter)



LED behaviour

The following table shows all the possible activation combinations of LEDs on the LED panel according to the operating status of the inverter.

- = LED On
- ⊗ = LED flashing
- ⊗ = LED Off
- ⊗ = Any

one of the conditions described above

LED status	Operating state
green: ⊗ yellow: ⊗ red: ⊗	Firmware programming The inverter firmware is being programmed
green: ⊗ yellow: ⊗ red: ⊗	Night mode (inverter automatically switches off) The inverter is in night time switch-off mode (input voltage less than 70% of the set start-up voltage).
green: ⊗ yellow: ⊗ red: ⊗	Inverter initialisation This is a transitional state due to the verification of the operating conditions. During this stage the inverter checks that the conditions for connecting to the grid are met.
green: ● yellow: ⊗ red: ⊗	The inverter is connected and is feeding power into the grid Normal operation. During this stage, the inverter automatically tracks and analyses the photovoltaic generator's maximum power point (MPP).
green: ⊗ yellow: ● red: ⊗	Disconnection from the grid Indicates no grid voltage. This condition does not allow the inverter to connect to the grid (the inverter display shows the message "Missing Grid").
green: ⊗ yellow: ● red: ⊗	Indication of Warning (W message codes) or Error (E message codes) Indicates that the inverter control system has detected a warning (W) or error (E). The display shows a message indicating the type of problem found (see Alarm messages).
	<ul style="list-style-type: none"> • Ventilation anomaly Indicates an anomaly in the operation of the internal ventilation system that could limit output power at high ambient temperatures.
	<ul style="list-style-type: none"> • Failed association of internal inverter components (after replacement) Indicates that the installed wiring box (only in the event of a replacement) was already associated with another inverter and cannot be associated with the new inverter
green: ⊗ yellow: ⊗ red: ⊗	<ul style="list-style-type: none"> • Overvoltage surge arresters triggered (where fitted) Indicates that any class II overvoltage surge arresters installed on the AC or DC side have been triggered
	<ul style="list-style-type: none"> • String protection fuses triggered (where fitted) Indicates that one or more input string protection fuses that may be installed have been triggered
	<ul style="list-style-type: none"> • Autotest (for Italian grid standards only) The inverter is performing an Autotest
green: ⊗ yellow: ⊗ red: ●	Anomaly in the insulation system of the photovoltaic generator Indicates that a leakage to ground from the PV generator has been detected, causing the inverter to disconnect from the grid.

Specifications on operation of the LEDs

In correspondence to each status of the inverter indicated by the constant or intermittent lighting of the specific LED, the display ⑦ also shows a message identifying the operation which is being carried out or the defect/anomaly recorded (see specific chapter).



In the case of malfunction it is extremely dangerous to intervene personally to try and eliminate the defect. The instructions below must be followed scrupulously; if you do not have the necessary experience and training to intervene safely, please contact a specialist.

LED insulation fault

Interventions after warning of insulation fault

When the red LED comes on, first try to reset the warning by pressing the multi-function ESC button on the keyboard ⑧.

Should the inverter reconnect normally to the grid, the fault was due to temporary phenomena.



You are advised to have the plant inspected by the installer or a specialist should this malfunction occur repeatedly.

Should the inverter not reconnect to the grid, isolate it on both the AC and DC sides (by using the disconnect switches), then contact the installer or authorised centre to repair the fault in the photovoltaic generator.





Description of the menus

The ABB inverters are equipped with a graphic display ①7, consisting of 2 lines of 16 characters each, which can be used to:

- Display the operating status of the inverter and the statistical data
- Display service messages for the operator
- Display the alarm and fault messages
- Change the inverter settings.

General information

While the inverter is operating, the display shows various items of information on the main parameters measured, the operating conditions and the inverter's operating status.

When the icon  appears on the display, information is shown cyclically; if the padlock icon  is displayed it means that the display of information is locked and the UP and DOWN buttons can be used to scroll through the screens of information instead.

The sequence of screens displayed is shown below, with a description of the parameters monitored.

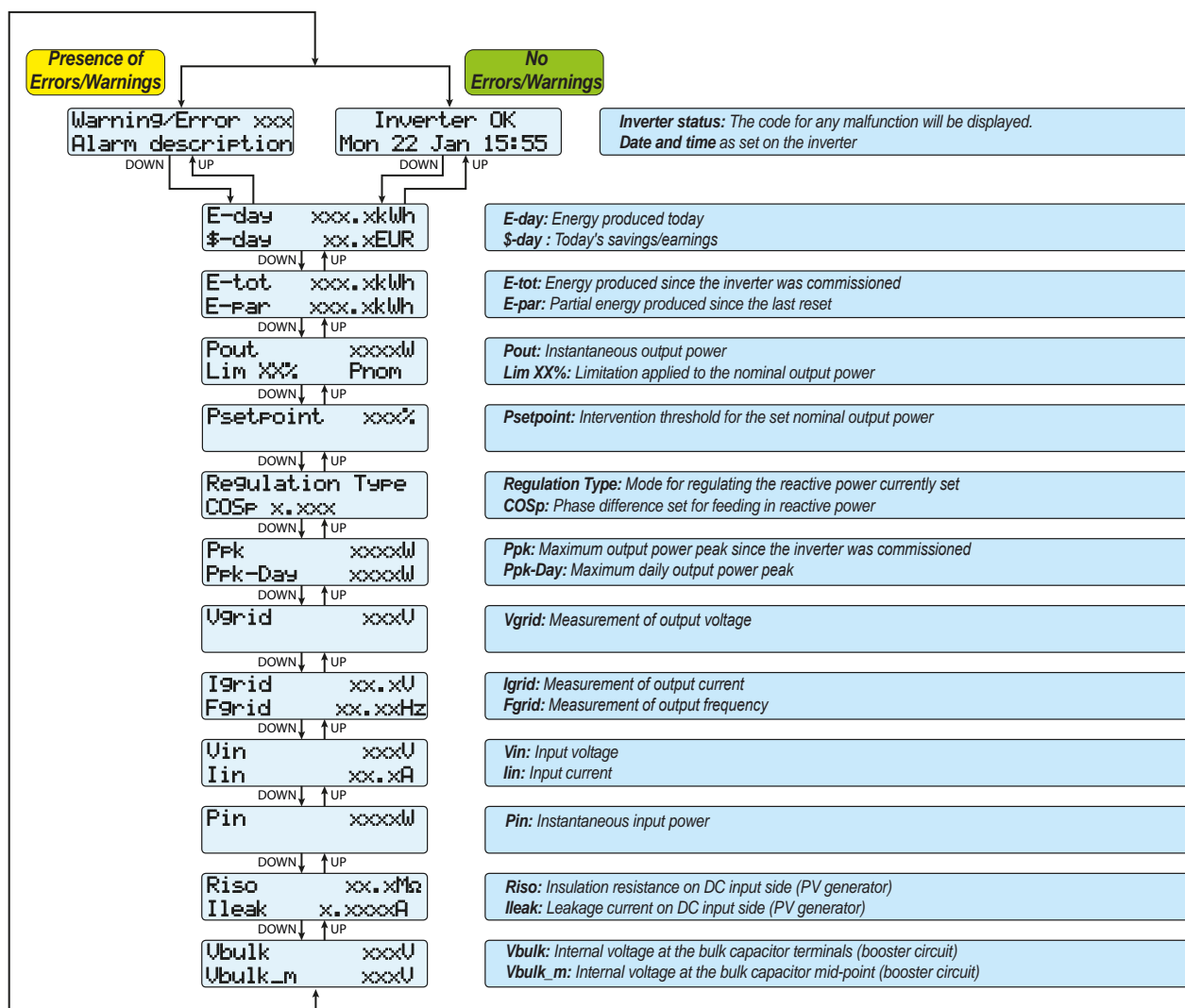

Menu structure

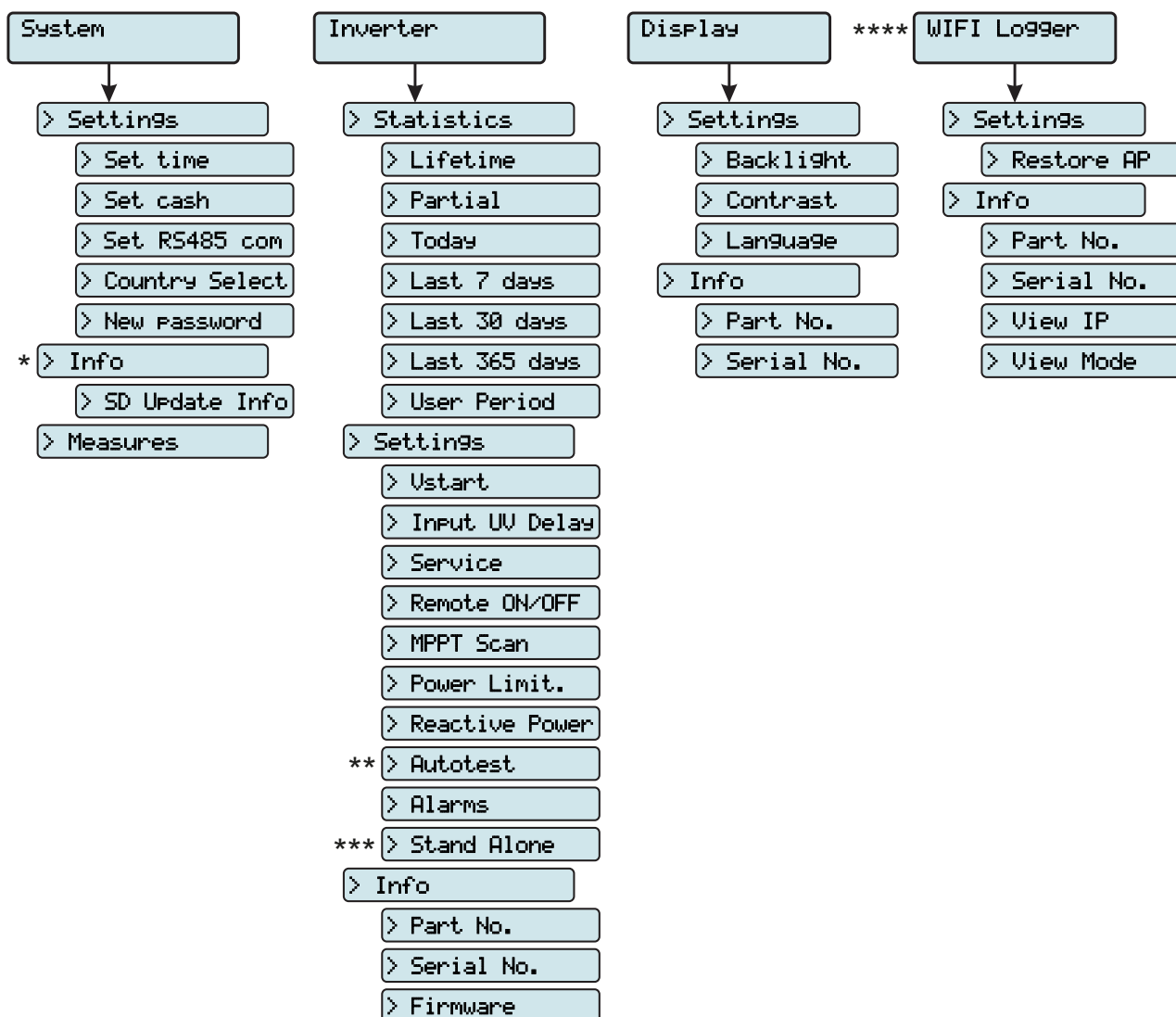

(*): Available only if previous firmware updates have been carried out via SD Card.

(**): Available for the Italian country standard only. Refer to the section on this topic in the manual.

(***): Available only if the "Stand Alone" accessory board has been installed in the unit.

(****): Available only if the "WIFI Logger Card" accessory board has been installed in the unit.

System Menu

By selecting the **System** menu, the following menus can be accessed:

(*) Available only if previous firm-ware updates have been carried out via SD Card.

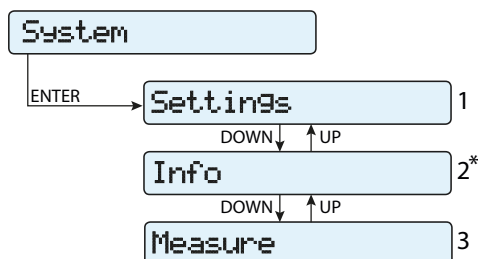

Settings

Selecting **Settings** brings up the first screen relating to the password.

The default password is "0000".

This can be modified by using the display buttons, always following the same procedure:

- ENTER scrolls through the digits (from left to right)
- ESC returns to the previous digit (from right to left)
- Press ESC several times to return to the previous menus
- DOWN scrolls down the numerical scale (from 9 to 0)
- UP scrolls up the numerical scale (from 0 to 9)

After entering the password, press ENTER to access the information in this section:

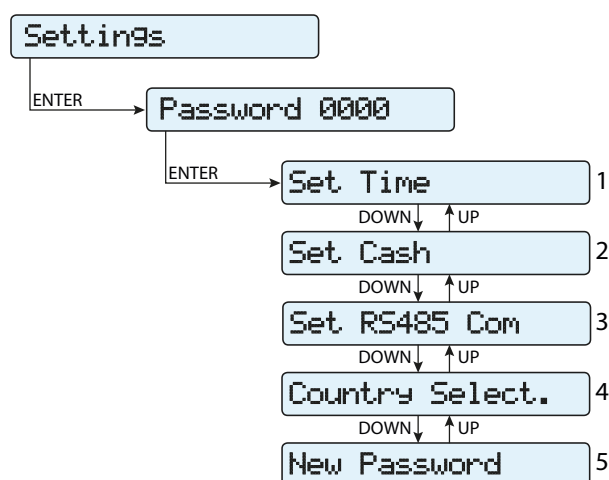

1. Set Time

Allows you to set the current date and time (not counting summer time)

2. Set Cash

This section of the menu allows you to set the name of the currency and the value of 1 kWh of energy produced. Setting these parameters correctly allows the actual earnings/savings achieved by the system to be displayed.

- **Currency:** sets the desired currency (default is Euro)
- **Val/KWh:** indicates the cost/incentive for 1 kWh in the chosen currency (default is 0.50).

3. Set RS485 Com

This section of the menu allows you to adjust the settings relating to the RS485 communication serial line:

- **Address:** It allows you to set the address for serial communication of the individual inverters connected to the RS485 line. The UP and DOWN buttons scroll through the numerical scale. (The addresses that can be assigned are 2 to 63).
- **Protocol:** It allows you to set the type of protocol to be used for the RS485 line. The proprietary "Aurora (slave)" protocol or "ModBus RTU" protocol can be selected.
- **Parity:** It allows you to set the Parity bit (None, Even, Odd).
- **Baud Rate:** It allows you to set the Baud Rate (2400/4800/9600/19200 /34800/57600/115200).

4. Country Select.

It allows you to modify the grid standard (this option can be selected before the inverter is switched on) within 24 hours while the inverter is operating.

- **Set Std:** allows you to set the required grid standard.
- **Residual Time:** indicates the time remaining until the "Country Select" feature is blocked.
- **Reset Country:** Unlocks the grid standard selection (resets the 24 hours available for changing the grid standard).

5. New Password

This section of the menu allows you to change the settings menu password (default 0000).



We advise you to memorise the new password.

If the Password is lost you will not have access to the inverter, since there is no Reset function for security reasons.



Info

The **Info** menu is only available if previous firmware updates have been carried out via SD Card.

By selecting **Info**, the following menus can be accessed:

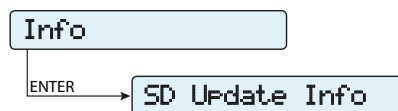

1. SD Update Info

This section of the menu is used to display the outcome of the firmware update of the various devices in the inverter carried out using the SD Card:

Supervisor	OK
G.Settings	OK
Language	OK
DC/AC	OK
Safety	OK

Measures

By selecting **Measures** it is possible to display the instantaneous value of the input power (PV Pw) and the instantaneous value of the output power (Pinv).



Inverter Menu

By selecting the **Inverter** menu, the following submenus can be accessed:

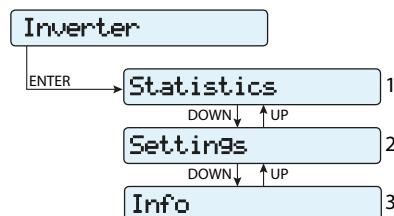

Statistics

By selecting **Statistics**, the following menus can be accessed:

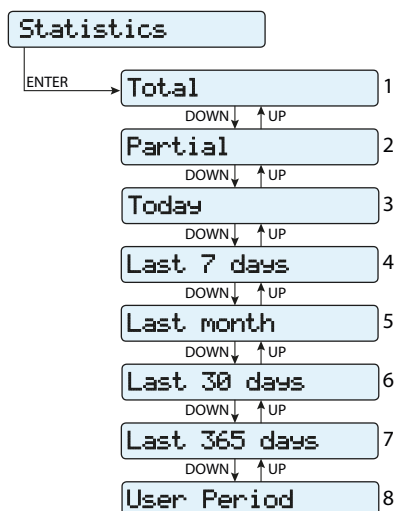

1. Total

This section of the menu displays the Total statistics:

- **Time:** Total operating time
- **E-tot:** Total energy produced
- **Val. :** Total production value, calculated using the currency and conversion coefficient set in the relevant section of the SETTINGS menu
- **CO₂:** Amount of CO₂ saved compared to fossil fuels

2. Partial

This section of the menu displays the Partial statistics:

- **Time:** Partial operating time
- **E-par:** Partial energy produced
- **P-Peak:** Peak power value
- **Val. :** Partial production value, calculated using the currency and conversion coefficient set in the relevant section of the SETTINGS menu
- **CO₂:** Partial amount of CO₂ saved



To reset all the counters of this sub-menu, press the ENTER button for more than 3 seconds. At the end of this time, you will hear a sound repeated 3 times.

3. Today

This section of the menu displays today's statistics:

- **E-day:** Energy produced today
- **P-Peak:** Today's peak power value
- **Val. :** Value of today's production, calculated using the currency and conversion coefficient set in the relevant section of the SETTINGS menu
- **CO₂:** Amount of CO₂ saved today

4. Last 7 days

This section of the menu displays the statistics for the last 7 days:

- **E-7d:** Energy produced over the last 7 days
- **Val. :** Value of production over the last 7 days, calculated using the currency and conversion coefficient set in the relevant section of the SETTINGS menu
- **CO₂:** Amount of CO₂ saved over the last 7 days

5. Last month

This section of the menu displays the statistics for the last month:

- **E-mon:** Energy produced during the current month
- **Val. :** Value of the last month's production, calculated using the currency and conversion coefficient set in the relevant section of the SETTINGS menu
- **CO₂:** Amount of CO₂ saved during the current month

6. Last 30 days

This section of the menu displays the statistics for the last 30 days:

- **E-30d:** Energy produced over the last 30 days
- **Val. :** Value of production over the last 30 days, calculated using the currency and conversion coefficient set in the relevant section of the SETTINGS menu
- **CO₂:** Amount of CO₂ saved over the last 30 days

7. Last 365 days

This section of the menu displays the statistics for the last 365 days:

- **E-365d:** Energy produced over the last 365 days
- **Val. :** Value of production over the last 365 days, calculated using the currency and conversion coefficient set in the relevant section of the SETTINGS menu
- **CO₂:** Amount of CO₂ saved over the last 365 days

8. User period

This section of the menu displays the statistics for a period chosen by the user.

Once the start and end dates for the period have been set, the following data are available:

- **E:** Energy produced over the selected period
- **Val. :** Value of production over the selected period, calculated using the currency and conversion coefficient set in the relevant section of the SETTINGS menu
- **CO₂:** Amount of CO₂ saved over the selected period



Settings

Selecting **Settings** brings up the first screen relating to the password.

The default password is "0000".

This can be changed by using the display buttons, following the same procedure as always:

- ENTER scrolls through the digits (from left to right)
- ESC returns to the previous digit (from right to left)
- Press ESC several times to return to the previous menus
- DOWN scrolls down the numerical scale (from 9 to 0)
- UP scrolls up the numerical scale (from 0 to 9)

After entering the password, press ENTER to access the information in this section:

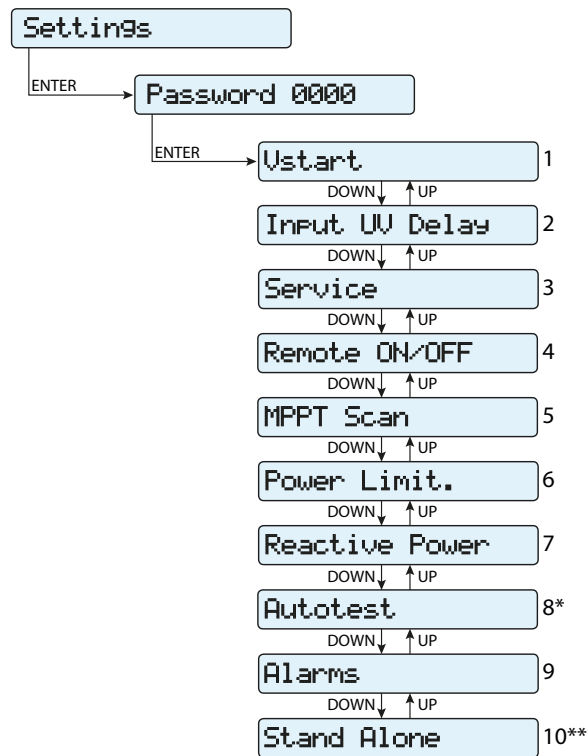

(*) Available for the Italian country standard only. Refer to the section on this topic in the manual.

(**) Available only if the "Stand Alone" accessory board has been installed in the unit. Refer to the section on this topic in the manual.



1. Vstart

This section of the menu is used to set the Vstart activation voltage to adapt it to the needs of the system. This voltage imposes a minimum input voltage on the inverter above which connection to the grid will be attempted.

For the single stage inverters (UNO-3.6/4.2-TL-OUTD) the activation voltage (Vstart) does not only depend on the input voltage value from the PV generator but also from the output voltage value. In fact, the activation voltage cannot be set to a value below the rectified value of the grid voltage which is calculated as $V_{grid} \times 1.414$.

Example: $V_{start} = 300V_{dc}$ $V_{grid} = 230V_{ac}$

Actual $V_{start} = (230 \times 1.414) + 30V = 325 + 30 = 355V_{dc}$

(The 30Vdc added to the rectified value of the grid voltage is a safety margin to prevent the operation at the limit of the inverter). For lower input voltage values, the message "waiting sun" will appear on the display.



We advise changing the activation voltage only if really necessary and to set it to the correct value: the photovoltaic generator sizing tool available on the ABB website will indicate whether Vstart needs changing and what value to set it to.

2. Input UV Delay

This section of the menu allows you to set the time for which the inverter stays connected to the grid after the input voltage has dropped below the Under Voltage limit (set at 70% of Vstart).

For the single stage inverters (UNO-3.6/4.2-TL-OUTD) the check is carried out on the input current rather than on the input voltage (when the input current becomes negative, the Input UV Delay count starts).

This value can be set from 1 to 3600 seconds (60 seconds as the default setting).

Example: Having set the Input UV Delay to 60 seconds, if voltage V_{in} drops below 70% of Vstart (UNO-2.0/3.0-TL-OUTD) or the input current becomes negative (UNO-3.6/4.2-TL-OUTD) at 9:00, the inverter stays connected to the grid (taking power from it) until 9:01.

3. Service

This section of the menu is reserved for installers.

A special access password is required, which may be obtained from the website <https://registration.ABBSolarinverters.com>.

Before connecting to the site, make sure you have all the information required to calculate your password: Inverter Model, Serial Number and week of manufacture of the Inverter

When you have a password you can set the parameters in the menu.

Changing the above-mentioned parameters may prevent disconnection from the grid if the new values exceed those given in the standards of the country of installation. If these parameters are changed to values outside the standard range, an interface protection must be installed external to the inverter in accordance with the requirements of the country of installation.

The table below shows the parameters which cannot be modified.

Parameter	Description
Set U>>	Grid over-voltage (OV) threshold (extended range)
Set U>	Grid over-voltage (OV) threshold (restricted range)
Set U> (10Min)	Grid over-voltage (OV) threshold (average grid voltage value)
Set U<	Grid under-voltage (UV) threshold (restricted range)
Set U<<	Grid under-voltage (UV) threshold (extended range)
Set F>>	Grid over-frequency (OF) threshold (extended range)
Set F>	Grid over-frequency (OF) threshold (restricted range)
Set F<	Grid under-frequency (UF) threshold (restricted range)
Set F<<	Grid under-frequency (UF) threshold (extended range)
Set Connect	
> Set U>Connect	Max. permissible voltage during checks prior to grid connection
> Set U<Connect	Min. permissible voltage during checks prior to grid connection
> Set F>Connect	Max. permissible frequency during checks prior to grid connection
> Set F<Connect	Min. permissible frequency during checks prior to grid connection
> Set Time con.	Grid check time prior to connection
> Set T GridFault	Grid check time prior to connection after a grid fault
Set Slow Ramp	Enables gradual ramping up of power after the grid connection.
Set OF Derating	
> OF Der. Mode	Selects the power derating mode in the event of grid over-frequency.
> OF Der. Res. T.	Time period after OF derating in which the inverter checks that the frequency is back within the operating ranges (parameters "F<Connect" "F>Connect") required by the grid standard before ramping up the output from the derating condition.
Set Stand Alone	Allows the Stand Alone board accessory to be enabled/disabled. Once this mode is enabled, the guided setup will automatically start.
Reset Latch	Allows the Latch alarms present to be reset manually



4. Remote ON/OFF

This section of the menu is used to enable / disable connection/disconnection of the inverter from the grid using the special control signal (**R+**).

- **Disable:** the connection/disconnection of the inverter to/from the grid is dictated by the input (voltage from the photovoltaic generator) and output (grid voltage) parameters of the inverter.
- **Enable:** connection/disconnection of the inverter from the grid is dictated (as well as by the inverter input - voltage from the photovoltaic generator - and output parameters - grid voltage) by the state of the signal **R+** with respect to the signal **R-**.

5. MPPT Scan

This section of the menu allows you to set the parameters of the maximum power point tracking (MPPT) function. This function is useful when there are areas of shade on the PV generator, which may create several points of maximum power on the operating curve.

- **E/D MPPT Scan:** Enables/disables the scan for identifying the maximum power point of the system.
- **Scan Interval:** This section allows you to set the time between scans. Remember that the shorter the scan interval the greater the loss of production, due to the fact that energy is transferred to the grid during the scan but not at the maximum power point. Each scan takes roughly 2 seconds.

6. Power Limit.

This section of the menu allows you to adjust the limit to the active power that the inverter can feed into the grid by setting the percentage of nominal power at which the limit should be triggered.

Setting it to 100% resets the default maximum power, which in some installation country standards may be 110% of nominal power



7. Reactive Power

This section of the menu may be used to manage the supply of reactive power into the grid. There are 5 possible types of management:

- **No Regulation:** no regulation of reactive power. To activate this mode, press **ENTER** and then press **ENTER** to confirm.
- **Cos-phi fixed:** Sets the power rating to a fixed value. To activate this mode, press **ENTER** and set the Cos-Phi value to Over excited or Under excited, from 1.000 to 0.8000; press **ENTER** to confirm.
- **Q steady:** Sets the reactive power to a fixed value. To enable this mode, select **Enable** and then **OK** (using the UP / DOWN arrows). When enabled, **Set value** will appear on the display, allowing you to set the value of the reactive power (as either Over or Under excited, from 1.000 to 0.001)
- **Cos-phi = f(P):** Power rating as a function of the active power supplied by the inverter. To enable this mode, select **Enable** and then **OK** (using the UP / DOWN arrows). When it has been enabled, **Load std curve** will appear on the display, allowing you to set the following control curve:

The curve can be modified using the Aurora Manager Lite configuration software

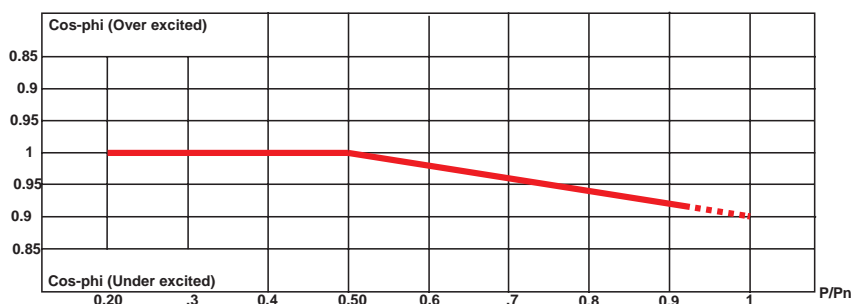

- **Q = f(U):** reactive power as a function of the grid voltage measured by the inverter. To enable this mode, select **Enable** and then **OK** (using the UP / DOWN arrows). When it has been enabled, **Load std curve** will appear on the display, allowing you to set the following control curve:

The curve can be modified using the Aurora Manager Lite configuration software

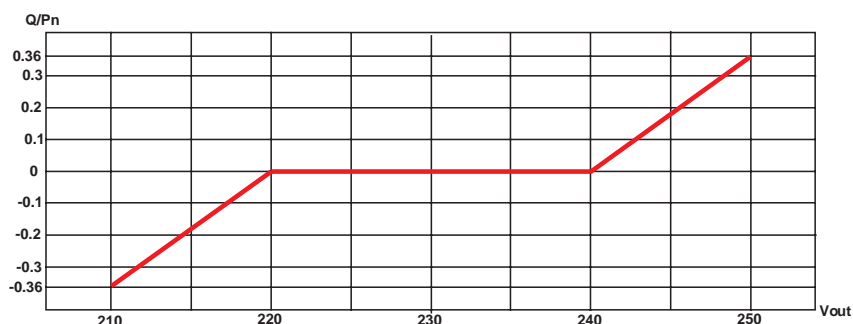

8. Autotest

This section of the menu is available only for the Italian country standard. Refer to the section on this topic in the manual.

9. Alarm

This section of the menu allows you to set the activation status of a relay (available either as contact normally open – N.O. - and as a normally closed contact -N.C.) and to configure customised alarm conditions.

This contact can be used, for example, to: activate a siren or a visual alarm, control the disconnect device of an external transformer, or control an external device.

Relay switching can be set in 9 different modes using the submenu **Set Alarm Type** (For the "Alarm Conf.", "Al. Conf. Latch", "Al. Conf. Ext.", "GoGo Rel(Auto)" and "GoGo Rel(Slave)" it is possible to configure customised alarm conditions through the submenu **Alarm Config** and **GoGo Config**):

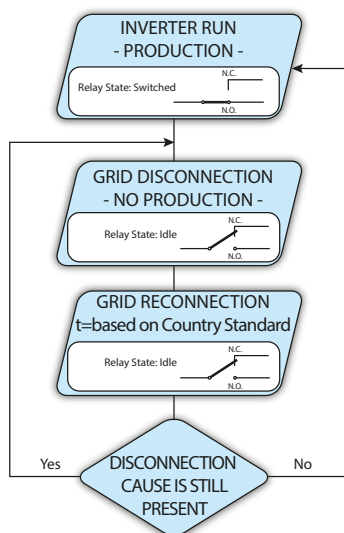

• Production (display text “Production”)

The relay is activated (status: switched) whenever the inverter connects to the grid; as soon as the inverter is disconnected from the grid (for whatever reason that caused disconnection), the relay is in its resting position.

• Alarm with reset at the end of the alarm signalling process (display text “Alarm”):

The relay is activated (status: switched) whenever an error (code Exxx) or warnings related to grid parameters out of range (Warning – codes W003, W004, W005, W006, W007) are present on the inverter. The alarm returns to its resting position when the alarm signal ends, i.e. before the inverter checks the grid parameters after the alarm state. This is because grid control state is not an alarm state but a state of normal operation.

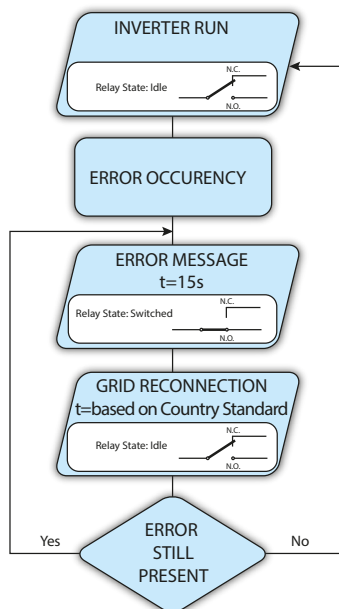

Alarms for which the relay is activated

E001	E002	E003	E004	E005	E006
E007	E009	E010	E011	E012	E013
E014	E015	E016	E017	E018	E019
E020	E021	E022	E023	E024	E025
E026	E027	E028	E029	E030	E031
E032	E033	E034	E035	E036	E037
E046	E050	E053	E054	E055	E056
E057	E058	E077	E078	E081	E084
E089	W003	W004	W005	W006	W007

In the presence of W003, W004, W005, W006, W007 signalling, the alarm contact switches to then reset itself at the end of the alarm signal. This means that during the absence of grid voltage (display message "Missing Grid") the alarm contact remains in its resting position.

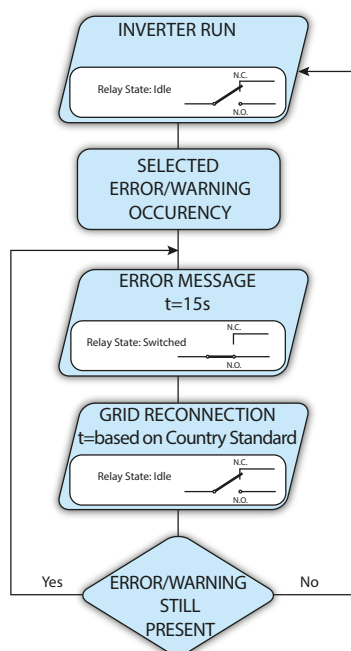

• **Configurable alarm with reset at the end of the alarm signalling process (display text “Alarm Conf.”)**

The relay is activated (status: switched) whenever an error (code Exxx) or a warning (code Wxxx) is present from those selected from the list in the dedicated submenu **Alarm Config**. The contact returns to its resting position when the alarm signal ends, i.e. before the inverter checks the grid after the alarm state. This is because grid control state is not an alarm state but a state of normal operation.

Selectable alarms for which the relay is activated

E001	E002	E003	E004	E005	E006
E007	E009	E010	E011	E012	E013
E014	E015	E016	E017	E018	E019
E020	E021	E022	E023	E024	E025
E026	E027	E028	E029	E030	E031
E032	E033	E034	E035	E036	E037
E046	E050	E053	E054	E055	E056
E057	E058	E077	E078	E081	E084
E089	W001	W002	W003	W004	W005
W006	W007	W009	W011	W015	W046
W047	W048	W051	W058	W059	

For the configurable relay operating mode “Alarm Conf.”, the following considerations are valid:

If the alarm condition is persistent, the alarm contact cyclically switches from its resting state to its activated state.

In the presence of W002 signalling (Input UV – input voltage below the limit of operation), the alarm contact switches to then reset itself at the end of the alarm signal. This means that during the reduced input voltage (display message “Waiting Sun”) the alarm contact remains in its resting position.

In the presence of W003, W004, W005, W006, W007 signalling, the alarm contact switches to then reset itself at the end of the alarm signal. This means that during the absence of grid voltage (display message “Missing Grid”) the alarm contact remains in its resting position.



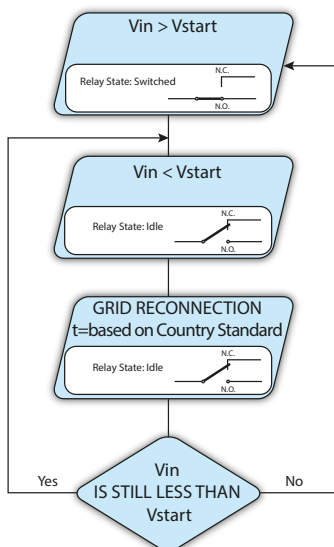

• Crepuscular (display text “Crepuscular”)

The relay is activated (status: switched) as soon as the inverter input voltage exceeds the activation voltage set.

For models UNO-2.0/3.0-TL-OUTD, the relay is in its rest position when the input voltage drops below 70% of the activation voltage set.

For single stage models UNO-3.6/4.2-TL-OUTD, the relay goes back to its rest position when the input voltage drops below the actual activation voltage (See paragraph dedicated to the "Vstart" activation voltage).

This mode is useful for disconnecting any output transformers that could have unnecessary consumption during the night.

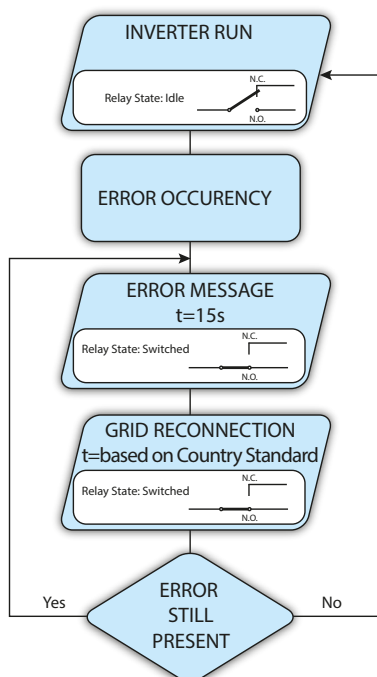

• Alarm Latch (display text “Alarm Latch”)

The relay is activated (status: switched) whenever an error (code Exxx) or a warning (code Wxxx) is present (see the table below). When the inverter returns to the normal operating state and reconnects with the grid, the contact returns to its position of rest.

Alarms for which the relay is activated

E001	E002	E003	E004	E005	E006
E007	E009	E010	E011	E012	E013
E014	E015	E016	E017	E018	E019
E020	E021	E022	E023	E024	E025
E026	E027	E028	E029	E030	E031
E032	E033	E034	E035	E036	E037
E046	E050	E053	E054	E055	E056
E057	E058	E077	E078	E081	E084
E089	W003	W004	W005	W006	W007

If the alarm condition is persistent, the relay will remain activated (status:switched)

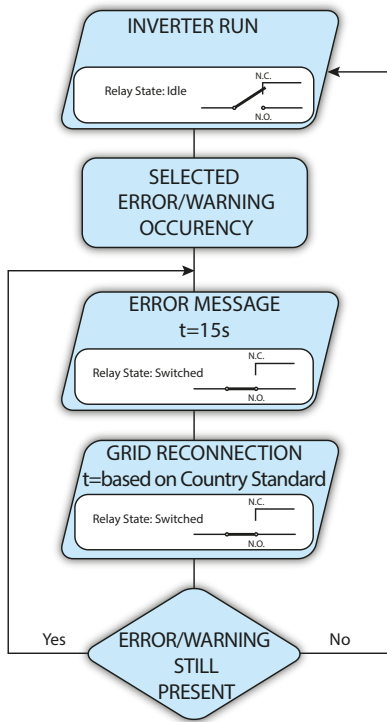

• **Latch configurable alarm (display text “Al. Conf. Latch”)**

The relay is activated (status: switched) whenever an error (code Exxx) or a warning (code Wxxx) is present from those selected from the list in the dedicated submenu **Alarm Config** (see the table below). When the inverter returns to the normal operating state and reconnects with the grid.

Selectable alarms for which the relay is activated

E001	E002	E003	E004	E005	E006
E007	E009	E010	E011	E012	E013
E014	E015	E016	E017	E018	E019
E020	E021	E022	E023	E024	E025
E026	E027	E028	E029	E030	E031
E032	E033	E034	E035	E036	E037
E046	E050	E053	E054	E055	E056
E057	E058	E077	E078	E081	E084
E089	W001	W002	W003	W004	W005
W006	W007	W009	W011	W015	W046
W047	W048	W051	W058	W059	

If the alarm condition is persistent, the relay will remain activated (status:switched)

• **Ext configurable alarm (display text “Al. Conf. Ext.”)**

In this mode, it is possible to configure the behaviour of the alarm relay according to an external error table which can be setup with the Aurora Manager LITE software. In the table it is possible to select the alarms or warnings for which the alarm relay is activated (status: switched); for each individual alarm it is also possible to select the "Latch" or "No Latch" mode.



- **Gogo Rel(Auto) (display text “Gogo Rel(Auto)”)**

It allows you to enable the GoGo Rel mode with which the relay is activated (status: switched) to a specific configurable power input threshold. Once this mode has been selected, the parameters for which the relay is activated have to be set (status: switched) and the parameters for which it is deactivated, in the dedicated submenu **GoGo Config**:

- **Pstart**: Upper power threshold (this can be set from 30% to 90% of the nominal input power) for which the relay is activated (status: switched).

- **Hyst OFF**: Lower power threshold (this can be set from 30% to 70% of the Pstart set) for which the relay returns to its rest position.

- **Min ON Time**: Minimum time period in which the relay is activated (status: switched) following the Pstart threshold being exceeded by the input power.

- **Min OFF Time**: Minimum time period in which the relay stays in its rest position after the input power has fallen below the Hyst OFF threshold.

10. Stand Alone

This section of the menu is only available if the "Stand Alone" accessory board has been installed and if the "Set Stand Alone" function has been enabled from the service menu (Inverter>Settings>Service). Through this section, it is possible to configure the operating mode of the "Stand Alone" accessory board selecting from "None" and "Man 1": Using "None" the board functions are disabled, while by selecting "Man1" they will be enabled.



Info

By selecting the **Info** menu, the following menus can be accessed:

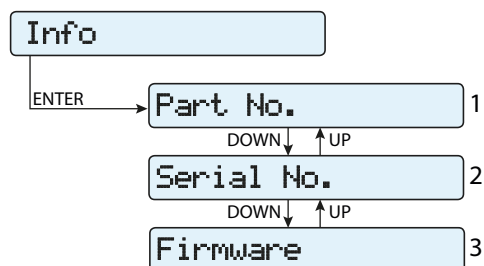

1. Part No.

Displays the model code

2. Serial number

Displays the serial number and week and year of manufacture of the equipment

3. Firmware

Lets you view the revision of the firmware installed on the equipment.



Display Menu

By selecting the **Display** menu, the following submenus can be accessed:

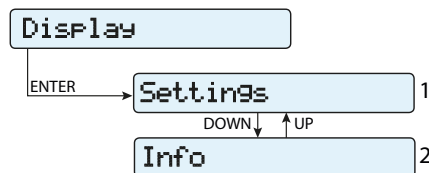

Settings

Selecting **Settings** brings up the first screen relating to the password. **The default password is "0000".**

This can be changed by using the display buttons, following the same procedure as always:

- ENTER scrolls through the digits (from left to right)
- ESC returns to the previous digit (from right to left)
- Press ESC several times to return to the previous menus
- DOWN scrolls down the numerical scale (from 9 to 0)
- UP scrolls up the numerical scale (from 0 to 9)

After entering the password, press ENTER to access the information in this section:

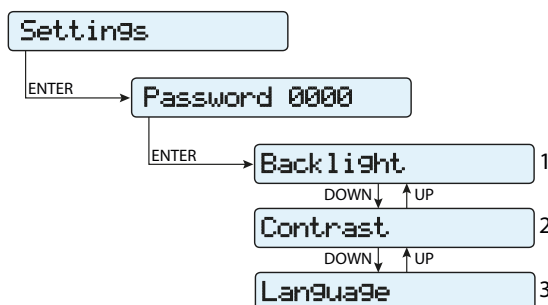

1. Backlight

This section of the menu allows you to set the backlighting display characteristics:

Mode:

ON: Light always on

OFF: Light always off

AUTO: Automatic backlight control. It activates each time a button is pressed and remains active for 30 seconds, after which time it gradually dims and deactivates.

Intensity: adjusts display brightness (scale from 1 to 9)

2. Contrast

This section of the menu allows you to set the contrast of the display (on a scale of 1 to 9).

3. Language

Allows you to set the language you prefer for the menus

Info

By selecting the **Info** menu, the following menus can be accessed:

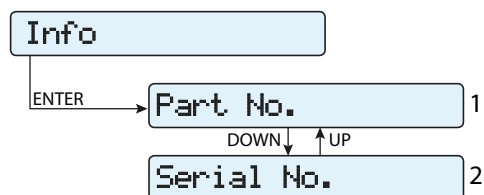

1. Part No.

Displays the model code

2. Serial number

Displays the serial number and week and year of manufacture of the equipment



WiFi Logger Menu

The **WiFi Logger** menu is available only if the WiFi Logger Card board has been installed in the unit.

By selecting the **WiFi Logger** menu, the following submenus can be accessed:

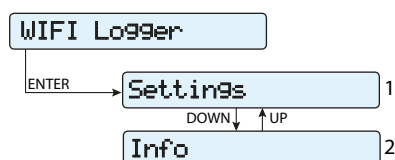

Settings

Selecting **Settings** brings up the first screen relating to the password.

The default password is "0000".

This can be changed by using the display buttons, following the same procedure as always:

- ENTER scrolls through the digits (from left to right)
- ESC returns to the previous digit (from right to left)
- Press ESC several times to return to the previous menus
- DOWN scrolls down the numerical scale (from 9 to 0)
- UP scrolls up the numerical scale (from 0 to 9)

After entering the password, press ENTER to access the information in this section:

1. Restore AP

This section of the menu allows you to restore the "Access Point" mode of the WiFi Logger Card accessory board (VSN300).



Info

By selecting the **Info** menu, the following menus can be accessed:

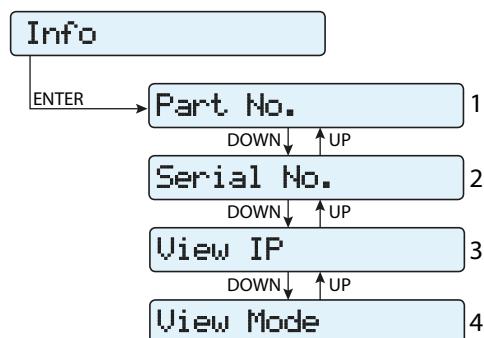

1. Part No.

Allows you to view the code of the WIFI Logger Card board model.

2. Serial number

Allows you to view the serial number, the week and year of manufacture of the WIFI Logger Card board.

3. View IP.

Allows you to view the IP address assigned to the WIFI Logger Card board.

4. View Mode

Allows you to view the operating mode of the WIFI Logger Card ("Access Point" or "Host").



AUTOTEST procedure in accordance with standard CEI 0-21

The autotest according to the grid standard **CEI-021** can be launched via the menu on the display.

The conditions required to perform an Autotest are:

- The grid standard must be set to CEI-021.
- You must not intervene in any way while the test is underway
- You must check that the equipment has a stable network connection.

Running the tests from the display menu

In the Autotest section of the SETTINGS menu, select the type of test the equipment is to run from the following:

OV Test – parameters:

U>>; U>; U> (10Min)

Disconnection from the distribution grid due to “Over-voltage”

UV Test – parameters:

U<<; U<

Disconnection from the distribution grid due to “Under-voltage”

OF Test – parameters:

F>> and F>

Disconnection from the distribution grid due to “Over-frequency”

UF Test – parameters:

F<< and F<

Disconnection from the distribution grid due to “Under-frequency”

Go to the SETTINGS > Autotest menu

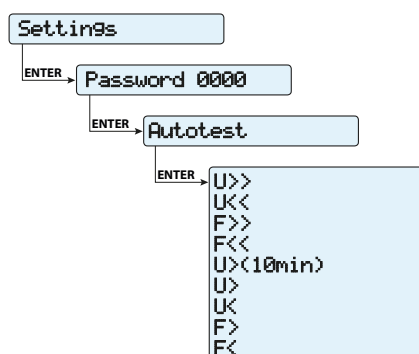

If one of the protections is disabled (from the Service menu), N/A (not applicable) will appear next to the name of the test.

While one of the tests is being performed, the set limits will be gradually increased/reduced (depending on the type of test) until the threshold at which the inverter is disconnected from the grid is reached. The procedures for running the Autotest comply with the legislation in force.

The display shows the message “Performing Test” when the test has started.



At the end of the test, when the inverter has disconnected from the grid, the results and values of the test performed will appear on the display. You can move from one screen to another using the UP/DOWN arrow keys.

Details of the data available in each screen are provided below:

Screen 1 of 3

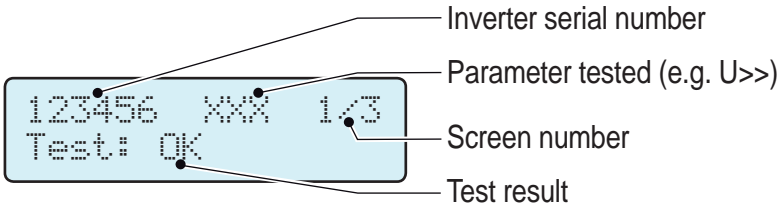

Screen 2 of 3

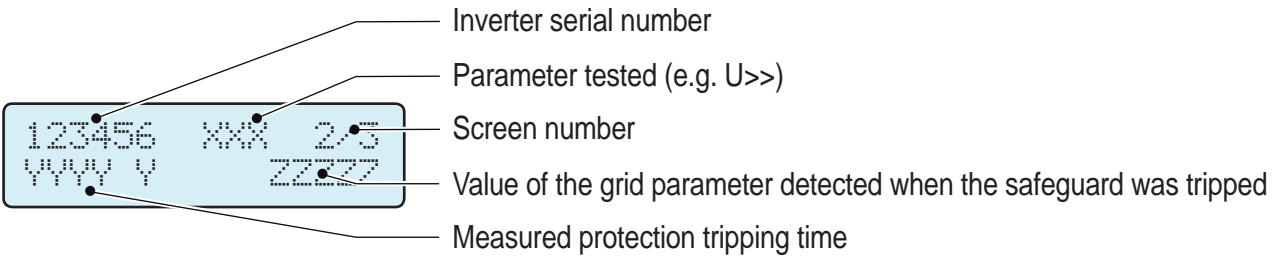

Screen 3 of 3

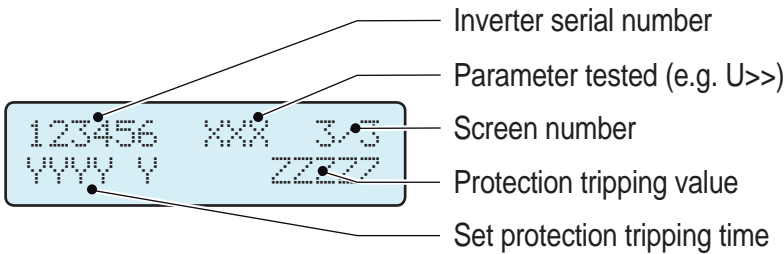

The test results should be considered valid on the basis of the following tolerances, as reported in the applicable legislation:

- **≤ 5% for voltage thresholds**
- **± 20 mHz for frequency thresholds**
- **≤ 3% ± 20 ms for tripping times**

Press ESC to go back to the Autotest menu, from where you may select the next test to be performed

Maintenance

8

General conditions

Checking and maintenance operations must be carried out by specialised staff assigned to carry out this work.



Maintenance operations must be performed with the equipment disconnected from the grid (power switch open) and the photovoltaic panels obscured or isolated, unless otherwise indicated.



*For cleaning, DO NOT use rags made of woven material or corrosive products that may corrode parts of the equipment or generate electrostatic charges.
Avoid temporary repairs. All repairs should be carried out using only genuine spare parts.
The maintenance technician is under an obligation to promptly report any anomalies.*

DO NOT allow the equipment to be used if problems of any kind are found, and restore the normal conditions correctly or otherwise make sure that this is done.



Always use the personal protective equipment provided by the employer and comply with the safety conditions indicated in the Accident prevention chapter.

Routine maintenance



Routine maintenance operations should not be considered obligatory, but rather as recommended in order to maintain the efficiency of the PV system.



It is recommended that maintenance operations are only performed by qualified personnel or ABB personnel (under a servicing contract).

The maintenance schedule may vary depending on the environmental conditions of the installation premises.

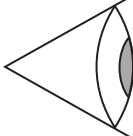
Table: routine maintenance

<p>Annual visual inspections</p> 	<ul style="list-style-type: none"> • Check that the inverter is operating properly, without any alarm signals • Ensure that all the safety labels and symbols are visible • Check the integrity of the cables, connectors and cable glands outside the inverter • Check that the environmental conditions have not changed dramatically from those on installation
<p>Annual operations</p> 	<ul style="list-style-type: none"> • Check the tightening of the cable glands and of the screw terminal blocks • Check the front cover is fixed • If there is no monitoring system, check the record of alarms and errors using the indications given in the manual in order to check recent malfunction signals
<p>Annual cleaning</p> 	<ul style="list-style-type: none"> • Clean the equipment; in particular the heat sink

Troubleshooting



In order to understand and resolve warning (Wxxx) or error (Exxx) signals that appear on the inverter's display, follow the table given in the following paragraph.











Operations on the inverter to identify and address any faults may only be performed by the installer or by qualified personnel.

Alarm Messages

The equipment can notify errors/warnings on the display only if the input voltage is greater than the V_{dcmin} voltage (POWER Led flashing or lit; see chapter on operation)

The messages and related codes are shown on the display.











The following table gives the complete list of errors/warnings relating to string inverters. Some error/warning codes may not be used depending on the inverter model installed.

- Code on display - Error message - Signal	Name of Alarm and Cause	Solution
<ul style="list-style-type: none"> - No code - Ground F -  Red LED 	<p>Ground fault of photovoltaic generator: The alarm is generated when a leakage current to ground is detected in the DC section of the system.</p>	<ul style="list-style-type: none"> • Measure the insulation resistance using a megohmmeter positioned in the photovoltaic field (positive terminal short-circuited at the negative pole) compared to ground. The measurement is strongly influenced by the environmental conditions, so must be made under the same conditions in which the error occurred. - If the value measured is lower than 1 megaohm, a check must be carried out by a technician/installer on the photovoltaic generator to identify and eliminate the problem. - If the value measured is higher than 1 megaohm and the error signal persists, contact customer assistance.
<ul style="list-style-type: none"> - No code - NEW SYSTEM PART REFUSED! -  Yellow LED lamp. 	<p>Lack of linkage of the new system part: The components inside the inverter (e.g. display, fuse board, communication and control board, etc.) are not inter-linked. This occurs following the replacement of one of the components inside the inverter.</p>	<ul style="list-style-type: none"> • Link the components inside the inverter by accessing the "Settings > Service > Accept boards" (refer to the procedure given in this manual). - If the signal persists also following the linking of the components, contact customer assistance.
<ul style="list-style-type: none"> - No code - SET COUNTRY or NO NATION -  No LED 	<p>SET COUNTRY or NO NATION: Indicates that in the installation phase the grid standard was not set on the inverter.</p>	<ul style="list-style-type: none"> • Set the grid standard of the country of installation following the instructions given in this manual for the inverter. - If the signal persists also after the grid standard has been set, contact customer assistance.
<ul style="list-style-type: none"> - No code - Missing Grid -  Yellow LED 	<p>Missing Grid: The inverter displays the "Missing Grid" message when it does not record output voltage (AC side).</p>	<ul style="list-style-type: none"> • Check the grid voltage on the inverter's AC terminal block. - Should it be absent, check any protection work on the line and the presence of grid voltage on the supply point.
<ul style="list-style-type: none"> - No code - Memory Fail -  Yellow LED lamp. 	<p>Memory fail: The inverter displays the "Memory Fail" message when it records a communication problem with the memory board on which the inverter saves the daily value of energy produced.</p>	<ul style="list-style-type: none"> • Remove the memory board and check the welding of all the connector's terminals. Subsequently reinsert the memory board and check that it is correctly inserted into the dedicated slot - If the signal persists also following the above checks, contact customer assistance.
<ul style="list-style-type: none"> - No code - Waiting Sun -  Green LED lamp. 	<p>Waiting Sun: The inverter displays the "Waiting Sun" message when, following a W001 and/or W002 notice, the voltage from the photovoltaic generator is less than the activation voltage (Vstart).</p>	<ul style="list-style-type: none"> • Check the input voltage on the inverter. - If it does not exceed Vstart, check for the presence of sufficient irradiation and the correct composition of the system. - If it exceeds Vstart, contact customer assistance
<ul style="list-style-type: none"> - W001 - Sun Low -  Yellow LED 	<p>Insufficient irradiation (Low input voltage on switching on the inverter): Incorrect configuration of the PV generator or an "on the limit" configuration for the inverter's minimum input voltage.</p>	<ul style="list-style-type: none"> • Check the input voltage on the inverter. - If it does not exceed Vstart, check for the presence of sufficient irradiation and the correct composition of the system. - If it exceeds Vstart, contact customer assistance
<ul style="list-style-type: none"> - W002 - Input UV -  Yellow LED 	<p>Insufficient irradiation (Low input voltage on switching off): Incorrect configuration of the photovoltaic generator or an "on the limit" configuration for the inverter's minimum input voltage</p>	<p>Check the input voltage on the inverter.</p> <ul style="list-style-type: none"> - If it does not exceed Vstart, check for the presence of sufficient irradiation and the correct composition of the system. - If it exceeds Vstart, contact customer assistance
<ul style="list-style-type: none"> - W003 - Grid Fail -  Yellow LED 	<p>Parameters of grid voltage outside range: This error signal occurs when during the inverter's normal operation the grid parameters exceed the limits set by the operator:</p> <ul style="list-style-type: none"> - Grid voltage absent (after the signal the inverter goes to "Missing Grid") - Unstable grid voltage (down or up) - Unstable grid frequency 	<ul style="list-style-type: none"> • Check the grid voltage on the inverter. - Should it be absent, check for absence of grid voltage on the supply point. - If, on the other hand, the voltage tends to rise (when the inverter is connected) there is high line or grid impedance. • Check the grid voltage also on the supply. - If it is high, it means that there is high grid impedance. In this case, ask the operator to adjust the grid voltage. If the operator authorises a change to the inverter's parameters, agree the new limits with customer assistance - If the voltage at the point of supply is much lower than that measured on the inverter, it is necessary to adjust the line (inverter-contactor). - If the voltage and the grid frequency come back within the limits (also when the inverter is connected to the grid) contact customer assistance



- Code on display - Error message - Signal	Name of Alarm and Cause	Solution
- W004 - Grid OV - ● Yellow LED	Grid overvoltage: This error signal occurs when during the inverter's normal operation the grid voltage exceeds the maximum limit set by the operator.	<ul style="list-style-type: none"> • Check the grid voltage on the inverter. If the voltage tends to rise (when the inverter is connected), there is a problem of high line or grid impedance. • Check the grid voltage also on the supply. <ul style="list-style-type: none"> - If it is high, it means that there is high grid impedance. In this case, ask the operator to adjust the grid voltage. If the operator authorises a change to the inverter's parameters, agree the new limits with customer assistance - If the voltage at the point of supply is much lower than that measured on the inverter, it is necessary to adjust the line (inverter-contactor). - If the voltage and the grid frequency come back within the limits (also when the inverter is connected to the grid), contact customer assistance
- W005 - Grid UV - ● Yellow LED	Grid undervoltage: This error signal occurs when during the inverter's normal operation the grid voltage exceeds the minimum limit set by the operator.	<ul style="list-style-type: none"> • Check the grid voltage on the inverter. • Check the grid voltage also on the supply: <ul style="list-style-type: none"> - If it is high, it means that there is high grid impedance. In this case, ask the operator to adjust the grid voltage. If the operator authorises a change to the inverter's parameters, agree the new limits with customer assistance - If the voltage at the point of supply is much lower than that measured on the inverter, it is necessary to adjust the line (inverter-contactor). - If the voltage and the grid frequency come back within the limits (also when the inverter is connected to the grid), contact customer assistance
- W006 - Grid OF - ● Yellow LED	Grid over-frequency: This error signal occurs when during the inverter's normal operation the grid frequency exceeds the maximum limit set by the operator.	<ul style="list-style-type: none"> • Check the grid frequency in the inverter. • Check the grid frequency also on the supply: <ul style="list-style-type: none"> - If the voltage and the grid frequency come back within the limits (also when the inverter is connected to the grid), contact customer assistance
- W007 - Grid UF - ● Yellow LED	Grid under-frequency: This error signal occurs when during the inverter's normal operation the grid frequency exceeds the minimum limit set by the operator.	<ul style="list-style-type: none"> • Check the grid frequency in the inverter. • Check the grid frequency also on the supply: <ul style="list-style-type: none"> - If the voltage and the grid frequency come back within the limits (also when the inverter is connected to the grid), contact customer assistance
- W009 - Empty Table - ● Yellow LED	Characterisation board for the wind generator not compiled (only WIND models)	(only WIND models)
- W010 * - Fan Fail - ⊗ Yellow LED lamp. *not visualised on display	Fan Fail: This error occurs when there is a malfunction in the fan/fans inside the inverter.	<ul style="list-style-type: none"> • Error inside the inverter and cannot be checked externally. - If the alarm repeats persistently, contact customer assistance.
- W011 - Bulk UV - ● Yellow LED	Low "Bulk" voltage (DC-DC circuit): The alarm (which is a warning and not an error) is generated when the voltage at the heads of the bulk capacitors does not reach the threshold for the operation of the inverter (internal unchangeable threshold).	<ul style="list-style-type: none"> • Raise the value of the activation voltage (Vstart) so as to have sufficient power from the PV generator at the time of the inverter's grid connection. • Check the input voltage on the inverter. <ul style="list-style-type: none"> - If it does not exceed Vstart, check for the presence of sufficient irradiation and the correct composition of the system. - If it exceeds Vstart, contact customer assistance
- W012 * - Batt. Low - ● Yellow LED *not visualised on display	Battery Low: The inverter displays the "Battery Low" message when it records a voltage for the buffer battery which is too low.	<ul style="list-style-type: none"> • Check that the date/time are set correctly and, if they are not, set them. • Subsequently arrange to completely switch off the inverter (on both AC and DC) and wait a few minutes. • Finally, restart the inverter and check whether the date/time are now correctly set or whether they have reset to 01/01/2000. In this case replace the battery with the inverter completely switched off (section AC and DC side) being careful to maintain the polarity
- W013 * - Clock Fail - ⊗ Yellow LED lamp. *not visualised on display	Clock Fail: The alarm occurs when there is a difference of over 1 minute in the time displayed compared to the internal time of the microprocessors and indicates a malfunction of the clock circuit.	<ul style="list-style-type: none"> • Error inside the inverter and cannot be checked externally. - If the alarm repeats persistently, contact customer assistance.















- Code on display - Error message - Signal	Name of Alarm and Cause	Solution
- W015 - Island Detect. -  Yellow LED	Disconnection due to Anti-Islanding: The inverter has been improperly connected to an island grid.	<ul style="list-style-type: none"> • Check that the grid to which the inverter is connected is not an island grid. - If the grid to which the inverter is connected is an island grid, switch the inverter off and then on again: if the problem persists, contact customer assistance.
- W017* - String Err. -  Yellow LED lamp. * (only for models with monitored string fuses)	Error recorded in measuring string currents: Damaged string protection fuse(s)	<ul style="list-style-type: none"> • Check with a multimeter the state of the fuses (positioned on the fuse boards). - If one or more fuses is open, arrange to replace them and check that the input current on the string(s) does not exceed the rating of the fuses (should parallel strings have been made outside the inverter). - If there are no damaged string fuses and the inverter continues to show the alarm message check whether the settings to be made through the Aurora Manager software are correct (presence or absence of one or more input strings).
- W018* - SPD DC Err -  Yellow LED lamp. * (only for models with monitored SPD)	Intervention of overvoltage surge arresters on DC side: Damaged overvoltage surge arresters positioned on DC side	<ul style="list-style-type: none"> • Observe the inspection window on each surge arrester (DC side). If it is red, the surge arrester is damaged and the cartridge must be replaced. - If the alarm status persists, even if all the surge arresters have a green inspection window, contact customer assistance.
- W019* - SPD AC Err -  Yellow LED lamp. * (only for models with monitored SPD)	Intervention of overvoltage surge arresters on AC side: Damaged overvoltage surge arresters positioned on AC side	<ul style="list-style-type: none"> • Observe the inspection window on each surge arrester (AC side). If it is red, the surge arrester is damaged and the cartridge must be replaced. - If the alarm status persists, even if all the surge arresters have a green inspection window, contact customer assistance.
- W022* - Reactive power mode changed -  No LED *not visualised on display	Variation in means of managing reactive power: Variation in the means of managing reactive power; this change can be made through the display or advanced configuration software.	The variation in the means of managing reactive power is done directly by the customer/installer and is not an error. The information is only saved on the historic record of the events memorised by the inverter
- W023* - date/time changed -  No LED *not visualised on display	Variation in the inverter's date and time: Variation of the inverter's date and time; this change can be made through the display or advanced configuration software.	<ul style="list-style-type: none"> • The variation in the inverter's date and time is done directly by the customer/installer and is not an error. The information is only saved on the historic record of the events memorised by the inverter
- W024* - Energy data reset -  No LED *not visualised on display	Zeroing of the statistical energy data memorised in the EEPROM: Reset of the energy data saved in the inverter; this operation can be handled through the display or advanced configuration software.	The zeroing of the partial energy values memorised by the inverter is done directly by the customer/installer and is not an error. The information is only saved on the historic record of the events memorised by the inverter <ul style="list-style-type: none"> • The notice may also occur on substitution of the Memory Card where the statistical production data is saved
- W026* - AFDD user reset -  No LED *not visualised on display	Reset of the Arc Fault error: Manual reset of the Arc Fault error; this operation can be made through the display or advanced configuration software.	<ul style="list-style-type: none"> • The reset of the Arc Fault error is done directly by the customer/installer and is not an error. The information is only saved on the historic record of the events memorised by the inverter
- W027* - Latch-Manual reset -  No LED *not visualised on display	Resetting of the Latch alarm conditions: Manual reset of the Latch alarm conditions; this operation can be made through the display or advanced configuration software.	<ul style="list-style-type: none"> • The reset of the Latch alarm conditions is done directly by the customer/installer and is not an error. The information is only saved on the historic record of the events memorised by the inverter
- W046 - Grid conn. fault -  Yellow LED	Connection to the grid unsuccessful The alarm is logged when a Missing grid or Input UV error occurs or due to the manual disconnection of the inverter during the grid connection sequence.	<ul style="list-style-type: none"> • Once the error occurs, the inverter tries to return to normal operation. - If the problem persists after a number of attempts to connect the inverter, switch the inverter off and then on again. - If the problem persists (once the inverter has been switched off and back on again), contact customer assistance.
- W047 - Update Incomplete -  Yellow LED	FW update method unsuccessful The alarm occurs when a firmware update has not been completed.	<ul style="list-style-type: none"> • Complete any pending firmware updates. - If the problem persists once the firmware updates have been completed, switch the inverter off and on again. - If the problem persists (once the inverter has been switched off and back on again), contact customer assistance.



- Code on display - Error message - Signal	Name of Alarm and Cause	Solution
- W048 - Periodic GridOff - ● Yellow LED	Automatic disconnection from the grid due to time limit: If the inverter exceeds the set grid connection time limit set by the grid standard, it will automatically have to carry out a disconnection and reconnection to the grid to carry out the Riso test.	<ul style="list-style-type: none"> The presence of this alarm is not an error as the automatic disconnection is prescribed by safety regulations. If the inverter disconnects in a shorter time than expected, contact customer assistance.
- W049 * - Global-Settings Event - ⊗ No LED *not visualised on display	Variation of the grid standard Variation of the inverter's grid standard; this change can be made through the display or advanced configuration software.	<ul style="list-style-type: none"> The variation in the inverter's grid standard is done directly by the customer/installer and is not an error. The information is only saved on the historic record of the events memorised by the inverter
- W051 - Exit from Stand Alone connection - ● Yellow LED	Exit from Stand-alone mode: The alarm is logged when the "Stand Alone" mode is deactivated or the inverter reconnects to the grid (this can only be seen if the Stand Alone accessory board has been installed).	<ul style="list-style-type: none"> Deactivation of the Stand Alone mode is done directly by the customer/installer or automatically by the inverter and is not an error.
- W058 - System Frozen - ● Yellow LED	Converter in locked state: The converter lock state is connected to an installation phase in which the starts-up and grid connection conditions are not yet present.	<ul style="list-style-type: none"> Complete the commissioning phase of the inverter. If the problem persists (once the commissioning phase has been completed and the inverter has been switched off and back on again), contact customer assistance.
- W059 - Output power Overload - ● Yellow LED	Overload on Stand-alone output: The alarm occurs when there is an excessive request for power by the grid with the inverter in "Stand Alone" mode (this can only be seen if the Stand Alone accessory board has been installed).	<ul style="list-style-type: none"> Disconnect one or more loads from the Stand Alone output. If the problem persists (once all loads have been disconnected and the inverter has been switched off and back on again), contact customer assistance.
- E001 - Input OC - ● Yellow LED	Input over-current (photovoltaic generator): The alarm occurs when the inverter's input current exceeds the inverter's threshold for maximum input current.	<ul style="list-style-type: none"> Check whether the composition of the PV generator enables input current which exceeds the maximum threshold allowed by the inverter and that the configuration of the inputs (independent or in parallel) is carried out correctly. If both checks are positive, contact customer assistance.
- E002 - Input OV - ● Yellow LED	Input overvoltage (photovoltaic generator): The alarm is generated when the input voltage (from the PV generator) exceeds the inverter's threshold of maximum input voltage. The alarm occurs before reaching the absolute threshold over which the inverter is damaged. When the inverter's input voltage exceeds the overvoltage threshold, the inverter will not start up due to the generation of the alarm.	<ul style="list-style-type: none"> It is necessary to measure the input voltage inside the inverter with a voltmeter. If it is higher than the maximum voltage of the operating range, the alarm is genuine and it is necessary to check the configuration of the PV generator. If the voltage has also exceeded the maximum input threshold the inverter could be damaged. If it is lower than the maximum voltage of the operating range, the alarm is caused by an internal malfunction and it is necessary to contact customer assistance.
- E003 - No Parameters - ● Yellow LED	DSP initialisation error: The main microcontroller cannot initialise correctly the two DSPs (booster stage and inverter stage). The error is caused by communication problems on the inverter's internal bus.	<ul style="list-style-type: none"> Error inside the inverter and cannot be checked externally. If the problem persists (once the inverter has been switched off and back on again), contact customer assistance.
- E004 - Bulk OV - ● Yellow LED	"Bulk" over-voltage (DC-DC circuit): Error inside the inverter. The alarm is raised when the voltage at the heads of the bulk capacitors exceeds the overvoltage threshold (internal unchangeable threshold).	<ul style="list-style-type: none"> The alarm may be triggered by causes external to the inverter: - An excessive input voltage can be recorded as a condition for bulk overvoltage. In this case it is advisable to check the inverter's input voltage and should this value be close to the input OV threshold, review the configuration of the photovoltaic generator. - Excessive grid voltage could cause the bulk voltage to rise in uncontrolled fashion with a consequent protection intervention and hence generation of the alarm. In these cases the alarm is transitory and the inverter automatically restarts - The alarm may be triggered by causes inside the inverter and in this case it is necessary to contact customer assistance.
- E005 - Comm.Error - ● Yellow LED	Communication error inside the inverter: The alarm occurs when there are communication problems between the control devices inside the inverter.	<ul style="list-style-type: none"> Error inside the inverter and cannot be checked externally. If the problem (once the inverter has been switched off and back on) persists, contact customer assistance.
- E006 - Output OC - ● Yellow LED	Output overcurrent: The alarm occurs when the inverter's output current exceeds the inverter's threshold for maximum output current.	<ul style="list-style-type: none"> Error inside the inverter and cannot be checked externally. If the problem (once the inverter has been switched off and back on) persists, contact customer assistance.















- Code on display - Error message - Signal	Name of Alarm and Cause	Solution
- E007 - IGBT Sat -  Yellow LED	Saturation recorded on the IGBT components: The alarm occurs when one of the inverter's active devices is in a saturated state.	Once the error occurs, the inverter tries to return to normal operation. - Should the error occur sporadically, it may be caused by a brusque transition of the grid voltage or of the input voltage, but is not due to a malfunction by the inverter. - If the error is connected to an internal breakdown, it will continue to appear and so it is necessary to contact customer assistance.
- E009 - Internal error -  Yellow LED	Error inside the inverter: Error inside the inverter	• Error inside the inverter and cannot be checked externally. - If the problem (once the inverter has been switched off and back on) persists, contact customer assistance.
- E010 - Bulk Low -  Yellow LED	Low "Bulk" voltage (DC-DC circuit): The alarm may be triggered by causes external to the inverter: a reduced input voltage on the inverter (just above the activation voltage) but which is not accompanied by a sufficient availability of power from the photovoltaic generator (typical condition of the stages with limited irradiation)	- If the error signal occurs sporadically, it may be due to causes external to the inverter (limited irradiation and so limited power availability from the PV generator). - If the problem occurs systematically also in conditions of high irradiation and with input voltage which is significantly higher than the activation voltage, contact customer assistance.
- E011 - Ramp Fail -  Yellow LED	Long wait for "Booster" regime to start: Error internal to inverter relating to start up time for DC-DC circuit regime (Booster)	• Error inside the inverter and cannot be checked externally. - If the problem (once the inverter has been switched off and back on) persists, contact customer assistance.
- E012 - DcDc Fail -  Yellow LED	Error in the "Booster" circuit (DC-DC side) recorded by the "Inverter" circuit (DC-AC side): Error internal to inverter relating to operation of the DC-DC circuit regime (Booster)	• Error inside the inverter and cannot be checked externally. - If the problem persists (once the inverter has been switched off and back on again), contact customer assistance.
- E013 - Wrong Mode -  Yellow LED	Incorrect configuration of inputs (set in parallel rather than independent): The alarm is generated solely when the inverter is configured with parallel inputs. In this particular configuration the inverter checks the input voltage of each of the two channels and if the two voltages differ by more than 20Vdc, the alarm is raised .	• Check that the setting of the "IN MODE" switch is specifically set to "PAR" and that the bridges between the two input channels have been included. - If the configuration of the inverter is correct, check that the input strings have the usual number of standard panels of the usual brand and with the same inclination/orientation. - If both the configuration of the inverter and the characteristics of the PV generator conform with the specifications, contact customer assistance.
- E014 - Over Temp. -  Yellow LED	Excessive temperature inside the inverter: External temperature over 60°C. This parameter also depends on the power which the inverter must supply since the measurement of temperatures is done internally and is influenced by the heat dissipated by the components of the inverter itself	• Check that the inverter is not exposed to direct sunlight. Wait for the temperatures to which the inverter is exposed to return to the operating range and for the inverter to cool down. - If the problem (once the ambient temperature has returned to the range) persists, contact customer assistance. Remember to wait the time needed to allow the inverter to cool down
 - E015 - Bulk Cap Fail -  Yellow LED	Fault recorded on the "Bulk" capacitor: Error inside the inverter relating to a problem in the bulk capacitors.	• Error inside the inverter and cannot be checked externally. - If the problem persists (once the inverter has been switched off and back on again), contact customer assistance.
- E016 - Inverter Fail -  Yellow LED	Error in the "Inverter" circuit (DC-AC side) recorded by the "Booster" circuit (DC-DC side): The alarm is generated when a problem is recorded in the inverter circuit (DC/AC)	• Error inside the inverter and cannot be checked externally. - If the problem persists (once the inverter has been switched off and back on again), contact customer assistance.
- E017 - Start Timeout -  Yellow LED	Long wait for "Inverter" regime to start up: Error internal to inverter relating to start-up time for the DC-AC circuit regime (Inverter) • The alarm may be triggered by causes external to the inverter: a reduced input voltage on the inverter (just above the activation voltage) but which is not accompanied by a sufficient availability of power from the photovoltaic generator (typical condition of the stages with limited irradiation)	- If the error signal occurs sporadically, it may be due to causes external to the inverter (limited irradiation and so limited power availability from the PV generator). - If the problem occurs systematically also in conditions of high irradiation and with input voltage which is significantly higher than the activation voltage, contact customer assistance.
- E018 - Ground Fault -  Red LED	High leakage current measured on the DC side (photovoltaic generator): The alarm is generated when, during normal operation of the inverter, a leakage current to ground is detected in the DC section of the system. It is also possible that the inverter generates the alarm E018 message also due to AC leakage currents connected to the capacitive nature of the photovoltaic generator compared to ground.	• Measure the insulation resistance using a megohmmeter positioned in the photovoltaic field (positive terminal short-circuited at the negative pole) compared to ground. The measurement is strongly influenced by the environmental conditions, so must be made under the same conditions in which the error occurred. - If the value measured is lower than 1 megaohm, a check must be carried out by a technician/installer on the photovoltaic generator to identify and eliminate the problem. - If the value measured is higher than 1 megaohm and the error signal persists, contact customer assistance.

- Code on display - Error message - Signal	Name of Alarm and Cause	Solution
- E019 - ILeak sense.fail - ● Yellow LED	Failure of test on sensor to measure the leakage current (DC side): Before connecting to the grid the inverter runs a autotest regarding the sensor for the leakage current. The test is carried out by "forcing", in the sensor of the leakage current, a current with a known value: the microprocessor compares the value read with the known value. The error is generated if the comparison between the read value and the known value during the test does not fall within the allowed tolerance.	<ul style="list-style-type: none"> • Error inside the inverter and cannot be checked externally. By its nature, the alarm only occurs prior to connection to the grid - If the problem (once the inverter has been switched off and back on) persists, contact customer assistance.
- E020 - Self Test Error 1 - ● Yellow LED	Failure of the test on the relay of the "Booster" (DC-DC circuit): Before connecting to the grid the inverter carries out internal tests. One of these tests concerns the correct operation of the booster relay. The test is carried out by "forcing" the switching of the relay and checking its operation. The error is generated if a problem is found in actioning the relay.	<ul style="list-style-type: none"> • Error inside the inverter and cannot be checked externally. By its nature, the alarm only occurs prior to connection to the grid - If the problem persists (once the inverter has been switched off and back on again), contact customer assistance.
- E021 - Self Test Error 2 - ● Yellow LED	Failure of the test on the inverter's relay (DC-AC circuit): Before connecting to the grid the inverter carries out internal tests. One of these tests concerns the correct operation of the inverter relay. The test is carried out by "forcing" the switching of the relay and checking its operation. The error is generated if a problem is found in actioning the relay.	<ul style="list-style-type: none"> • Error inside the inverter and cannot be checked externally. By its nature, the alarm only occurs prior to connection to the grid - If the problem persists (once the inverter has been switched off and back on again), contact customer assistance.
- E022 - Self Test Error 4 - ● Yellow LED	Timeout of the tests undertaken on the relays inside the inverter: Execution time for the autotest carried out on the relay of the DC_AC (inverter) circuit too high. It may indicate a problem connected to the aforementioned relays	<ul style="list-style-type: none"> • Error inside the inverter and cannot be checked externally. - If the problem persists (once the inverter has been switched off and back on again), contact customer assistance.
- E023 - DC in error - ● Yellow LED	Feeding of direct current to grid outside of range: The error is generated if the continuous component of the current supplied to the grid exceeds the threshold of 0.5% of the normal operating current. In any case the inverter is not blocked due to the E023 error, but tries to reconnect to the grid. The sporadic repetition of the error is a sign of serious grid distortions or sharp irradiation changes, while systematic repetition of the error signal will indicate a breakdown on the inverter	Once the error occurs, the inverter tries to return to normal operation. <ul style="list-style-type: none"> - Should the error occur sporadically, it may be caused by a brusque transition of the grid voltage or of the input voltage, but is not due to a malfunction by the inverter. - If the error is connected to an internal breakdown, it will continue to appear and so it is necessary to contact customer assistance.
- E024 - Internal error - ● Yellow LED	Error inside the inverter: Error inside the inverter	<ul style="list-style-type: none"> • Error inside the inverter and cannot be checked externally. - If the problem persists (once the inverter has been switched off and back on again), contact customer assistance.
- E025* - Riso Low - ● Yellow LED *not visualised on display	Low value of insulation resistance: Before connecting to the grid the inverter measures the insulation resistance of the PV generator compared to ground. Should the measurement of the insulation resistance be below 1Mohm, the inverter does not connect to the grid and shows the "Riso Low" error. The causes may be: - PV panel(s) damaged; - Junction box(es) of the panels not correctly sealed, so as to permit infiltration by water and/or humidity; - Problems in connections between panels (not perfectly fit); - Poor quality of cable joints; - Presence in the DC section of unsuitable or damaged overvoltage surge arresters outside the inverter (reduced ignition voltage compared to the characteristics of the strings of the PV generator); - Presence of humidity inside any junction box	<ul style="list-style-type: none"> • Measure the insulation resistance using a megohmmeter positioned in the photovoltaic field (positive terminal short-circuited at the negative pole) compared to ground. The measurement is strongly influenced by the environmental conditions, so must be made under the same conditions in which the error occurred. - If the value measured is lower than 1 megaohm, a check must be carried out by a technician/installer on the photovoltaic generator to identify and eliminate the problem. - If the value measured is higher than 1 megaohm and the error signal persists, contact customer assistance.
- E026 - Vref Error - ● Yellow LED	Internal reference voltage outside of range: Wrong measurement of reference voltage inside inverter	<ul style="list-style-type: none"> • Error inside the inverter and cannot be checked externally. - If the problem persists (once the inverter has been switched off and back on again), contact customer assistance.





- Code on display - Error message - Signal	Name of Alarm and Cause	Solution
- E027 - Error Meas V - Yellow LED	Grid voltage outside of range: Error in the internal measurement of grid voltage (set by law) in order to have a redundant measurement (2 measurements on the same parameter made by two different circuits)	• Error inside the inverter and cannot be checked externally. - If the problem persists (once the inverter has been switched off and back on again), contact customer assistance.
- E028 - Error Meas F - Yellow LED	Grid frequency outside of range: Error in the internal measurement of grid frequency (set by law) in order to have a redundant measurement (2 measurements on the same parameter made by two different circuits)	• Error inside the inverter and cannot be checked externally. - If the problem persists (once the inverter has been switched off and back on again), contact customer assistance.
- E029 - Mid Bulk OV - Yellow LED	Internal overvoltage on the measurement of the "Mid bulk": Error inside the inverter (only triphase models)	• Error inside the inverter and cannot be checked externally. - If the problem persists (once the inverter has been switched off and back on again), contact customer assistance.
- E030 - Error Meas Ileak - Yellow LED	High leakage current (DC side): Error in the internal measurement (made when the inverter is grid connected) of the leakage current of the DC side (PV generator) compared to ground (set by law) in order to have a redundant measurement (2 measurements on the same parameter made by two different circuits)	• Error inside the inverter and cannot be checked externally. - If the problem persists (once the inverter has been switched off and back on again), contact customer assistance.
- E031 - Error Read V - Yellow LED	Output relay damaged: Measurement of internal voltage on heads of the output relay outside of range. There is too great a difference in voltage between the input and output of the grid connection relay.	• Error inside the inverter and cannot be checked externally. - If the problem persists (once the inverter has been switched off and back on again), contact customer assistance.
- E032 - Error Read I - Yellow LED	Imbalanced output currents: Measurement of the imbalance in the output voltage (carried out across the three phases) outside of range (only in triphase models)	• Error inside the inverter and cannot be checked externally. - If the problem persists (once the inverter has been switched off and back on again), contact customer assistance.
- E033 - UTH - Yellow LED	Low ambient temperature: Temperature outside the inverter below -25°C	• Wait for the temperatures to which the inverter is exposed to return to the operating range. - If the problem persists, contact customer assistance. Remember to wait the time needed to allow the inverter to warm up
- E034 - Interlock fail - Yellow LED	"IGBT" circuitry not ready: Error inside the inverter	• Error inside the inverter and cannot be checked externally. - If the problem persists (once the inverter has been switched off and back on again), contact customer assistance.
- E035* - Remote Off - Yellow LED *not visualised on display	Inverter awaiting "remote ON" command: The inverter has been switched off remotely (remote OFF) and remains awaiting the signal which will switch it back on (Remote ON)	• Switch the inverter back on remotely. If the unit does not switch back on, disable the remote off/on function and switch the equipment off completely and subsequently switch it back on. - If the problem persists (once the Remote ON/OFF function from the display has been reactivated), contact customer assistance.
- E036 - Vout Avg error - Yellow LED	Average of the measurements of grid voltage outside of range: The average value of the grid voltage (sampled every 10 minutes) does not fall within the permitted ranges. The grid voltage in the point connected to the inverter is too high. This may be caused by too high a grid impedance. In the final stage of the timeout, the inverter limits the power to check whether the grid voltage has stabilised into regular parameters. If this does not happen, the inverter disconnects from the grid	• Check the grid voltage in the connection point to the inverter. - If the grid voltage differs from the range due to the conditions of the distribution grid, ask the operator to adjust the grid voltage. If the operator authorises a change to the inverter's parameters, agree the new limits with customer assistance
- E037 - Riso Low - Red LED	Low value of the insulation resistance (only with the "Amorphous" mode activated): This error can occur only should the "Amorphous" mode be on. This function is on only in inverters equipped with a grounding kit and serves to monitor the voltage at the heads of the grounding resistance. The error occurs when the voltage at the heads of the resistance connected between ground and the pole of the photovoltaic generator exceeds 30V for more than 30 minutes or 120V for more than one second.	• Check for the presence and correct contact between the two terminals of the grounding resistance installed inside the inverter • Measure the insulation resistance using a megohmmeter positioned in the photovoltaic field (positive terminal short-circuited at the negative pole) compared to ground. The measurement is strongly influenced by the environmental conditions, so must be made under the same conditions in which the error occurred. - If the value measured is lower than 1 megaohm, a check must be carried out by a technician/installer on the photovoltaic generator to identify and eliminate the problem. - If the value measured is higher than 1 megaohm and the error signal persists, contact customer assistance.



- Code on display - Error message - Signal	Name of Alarm and Cause	Solution
E046 - String self test fail -  No LED	Error during the automatic check of the string voltages (only in models with the “fuse-control” board): In some inverter models it is possible to carry out the check test of the polarity of the strings connected to the input (e.g.:TRIO-20.0/27.6kW). This error signal occurs when, during the test stage, an inverted string is recorded	<ul style="list-style-type: none"> • Section the inverter and check the polarity of the string(s) which the inverter has recorded as inverted. - Once all the strings have been correctly connected, activate the system once again; the inverter will once again check the correct polarity of the string inputs at the end of which it will carry out the checks for the grid connection. - If the problem persists (once the inverter has been switched off and back on again), contact customer assistance.
E049 - AC FF Error -  Yellow LED	Error in the “AC feed-forward” circuit: Error inside the inverter	<ul style="list-style-type: none"> • Error inside the inverter and cannot be checked externally. - If the problem persists (once the inverter has been switched off and back on again), contact customer assistance.
E050 - AFDD Activated -  Red LED	Arc Fault protection activated: Possible photovoltaic arc detected on the DC side.	<ul style="list-style-type: none"> • If it is the first time this problem has occurred, press the ESC button for 5 seconds and wait for the unit to restart. - If the problem persists (once the inverter has been switched off and back on again), contact customer assistance.
E053 - AFDD Fault -  Yellow LED	Arc Fault board autotest failed: Problem detected during the AFDD board autotest phase.	<ul style="list-style-type: none"> • Error inside the inverter and cannot be checked externally. - If the problem persists (once the inverter has been switched off and back on again), contact customer assistance.
E054 - AFDD comm. Fault -  Yellow LED	Arc Fault board communication error: Error on the RS485 serial communication detected between the inverter and the AFDD board.	<ul style="list-style-type: none"> • Error inside the inverter and cannot be checked externally. - If the problem persists (once the inverter has been switched off and back on again), contact customer assistance.
E055 - AFDD wrong conf. -  Yellow LED	Arc Fault board parameter reading error: Error in the parameter reading by the system.	<ul style="list-style-type: none"> • Error inside the inverter and cannot be checked externally. - If the problem persists (once the inverter has been switched off and back on again), contact customer assistance.
E056 - Over Temp. (from external box) -  Yellow LED	Excessive temperature measured inside the inverter's wiring box: High internal temperature. This error relates to the temperature measured on external boxes (e.g.:TRIO-20.0/27.6kW).	<ul style="list-style-type: none"> • Check that the inverter is not exposed to direct sunlight. Wait for the temperatures to which the inverter is exposed to return to the operating range and for the inverter to cool down. - If the problem persists (once the ambient temperature has returned to the range) persists, contact customer assistance. Remember to wait the time needed to allow the inverter to cool down
E057 - Vbulk reading error -  Yellow LED	Input voltage (Vin) higher than booster voltage (Vbulk): The error occurs if the input voltage exceeds the Bulk voltage (voltage on the DC-DC circuit inside the inverter)	<ul style="list-style-type: none"> • It is necessary to measure the input voltage inside the inverter with a voltmeter. - If it is higher than the maximum voltage of the operating range, the alarm is genuine and it is necessary to check the configuration of the PV generator. If the voltage has also exceeded the maximum input threshold the inverter could be damaged. - If it is lower than the maximum voltage of the operating range, the alarm is caused by an internal malfunction and it is necessary to contact customer assistance.
E058 - Pin vs Pout check error -  Yellow LED	Error in the check of Pin vs Pout: The error occurs if the difference between the measured value of input power and that of output power is greater than the limit imposed internally to the inverter.	<ul style="list-style-type: none"> • Error inside the inverter and cannot be checked externally. - If the problem persists (once the inverter has been switched off and back on again), contact customer assistance.
E077 - Internal Error -  Yellow LED	Error in the system configuration: Error inside the inverter	<ul style="list-style-type: none"> • Error inside the inverter and cannot be checked externally. - If the problem persists (once the inverter has been switched off and back on again), contact customer assistance.
E078 - Riso Test fail -  Yellow LED	Riso test error: Problem detected during the Riso test phase.	<ul style="list-style-type: none"> • Error inside the inverter and cannot be checked externally. - If the problem persists (once the inverter has been switched off and back on again), contact customer assistance.
E079 - Wrong Sequence -  Yellow LED	Incorrect Phases connection (Only triphase models) The phases have not been connected correctly to the AC output	<ul style="list-style-type: none"> • Invert two of the phases of the network wiring to the AC terminal block of the inverter.



- Code on display - Error message - Signal	Name of Alarm and Cause	Solution
E081 - Internal Error -  Red LED	Inverter fault / Incomplete inverter closing: Fault inside the inverter or incomplete inverter closing (front cover missing or not tightened, cable glands missing or incorrectly tightened, environmental protection IP65 not guaranteed)	<ul style="list-style-type: none"> • If the problem has occurred during the installation phase or during the inverter maintenance phase (therefore the cover has been removed or the cable glands have been acted upon), carry out the following operations: <ul style="list-style-type: none"> - Disconnect the AC grid and DC input from the inverter and check for the front cover and all the cable glands, also checking their correct tightening to ensure environmental protection IP65; reconnect the AC grid and the DC input and attempt to switch the inverter on; if the problem persists, contact customer assistance : - If the front cover and all cable glands are present, disconnect the AC grid and DC input from the inverter and wait 15 minutes at a safe distance, then open the inverter cover and if no smoke/smell of burning is present, check the integrity of the components or the presence of moisture or other abnormal conditions; reconnect the AC grid and DC input and attempt to switch on the inverter; if the problem persists contact customer assistance. • If the problem has occurred after installation or after an inverter maintenance phase (therefore the cover has NOT been removed or the cable glands have NOT been acted upon), disconnect the AC grid and the DC input from the inverter and contact customer assistance.
E084 - BackFeed OC -  Yellow LED	Return current to photovoltaic field: The error occurs if the input voltage is particularly low (typically in the evening in conditions of low irradiation) and indicates a return current from the inverter to the photovoltaic panels).	If the error occurs in the evening or in conditions of low irradiation, it must not be considered a problem but a protection intervention for the photovoltaic field. - If the problem occurs with good irradiation conditions, switch the inverter off and back on again; if the error persists, contact customer assistance.
E089 - Wrong Wiring -  Yellow LED	Incorrect grid wiring connection on Stand Alone: The error occurs if the grid cables have been incorrectly connected to the Stand Alone output.	<ul style="list-style-type: none"> • Check that the cables on the Stand Alone output have been installed correctly.



Power limitation messages

The equipment can signal possible output power limitations which may occur on the basis of:



- settings made by the user
- settings required by the grid standard of the country of installation
- protective devices inside the inverter

The messages are shown on the display.

The following table gives the complete list of power limitation messages relating to string inverters. Some messages may not be used depending on the inverter model installed.

- Message on display - Signal	Name of Derating and Cause	Solution
- LIMxxx% CODE:00 - ▲ Display symbol <u>b6</u>	Power limitation: The message indicates that the user has set an output power limitation for the inverter. LIM xxx% = Power reduction percentage Examples: LIM 100% = no power limitation LIM 50% = limitation to 50% of the output nominal power	<ul style="list-style-type: none"> • Check the limitation value set in the “Settings > Power Reduction” menu
- LIMxxx% CODE:01 - ▲ Display symbol <u>b6</u>	Power limitation for over-frequency: The message indicates that the user has set a power limitation due to over frequency in order to reduce the maximum output power of the inverter when the grid frequency exceeds certain limits. LIM xxx% = Power reduction percentage Examples: LIM 100% = no power limitation LIM 50% = limitation to 50% of the output nominal power	<ul style="list-style-type: none"> • Check the limitation value set in the “Settings > Service Power > OF Derating” menu
- LIMxxx% CODE:02 - ▲ Display symbol <u>b6</u>	Power limitation for over-voltage: The message indicates that the user has set a power limitation due to overvoltage (parameter U >(10 min)) in order to reduce the maximum output power of the inverter when the reading of the average grid voltage exceeds certain limits. The sampling of readings is done every 10 minutes (U>(10min)). LIM xxx% = Power reduction percentage Examples: LIM 100% = no power limitation LIM 50% = limitation to 50% of the output nominal power	<ul style="list-style-type: none"> • Check the limitation value set in the “Settings > Service Power > U > (10 min) Der.” menu
- LIMxxx% CODE:03 - ▲ Display symbol <u>b6</u>	Anti-islanding power limitation: The message indicates that a power limitation is active since an "islanding" condition has been recorded. LIM xxx% = Power reduction percentage Examples: LIM 100% = no power limitation LIM 50% = limitation to 50% of the output nominal power	<ul style="list-style-type: none"> • If the inverter remains connected to the grid and the limitation is active, contact customer assistance
- LIMxxx% CODE:04 - ▲ Display symbol <u>b6</u>	Power limitation due to low grid voltage: The message indicates that an output power limitation may occur since a low grid voltage (AC) condition has been recorded. LIM xxx% = Power reduction percentage Examples: LIM 100% = no power limitation LIM 50% = limitation to 50% of the output nominal power	<ul style="list-style-type: none"> • Check that the grid voltage is lower than the minimal voltage. Should this condition persist, contact the grid operator to resolve the problem.



- Message on display - Signal	Name of Derating and Cause	Solution
- LIMxxx% CODE:05 -  Display symbol <u>b7</u>	Power limitation due to excess temperature: The message indicates that a power limitation is active since an excess temperature condition has been recorded inside the inverter (This parameter depends also on the power which the inverter must provide since the measurement of temperatures is taken internally and is influenced by the heat dissipated by the components of the inverter itself). LIM xxx% = Power reduction percentage Examples: LIM 100% = no power limitation LIM 50% = limitation to 50% of the output nominal power	<ul style="list-style-type: none"> • Check that the inverter is not exposed to direct sunlight. Wait for the temperatures to which the inverter is exposed to return to the operating range and for the inverter to cool down. - If the problem (once the ambient temperature has returned within the range) persists, contact customer assistance.
- LIMxxx% CODE:06 -  Display symbol <u>b6</u>	Power limitation for input over-voltage: The message indicates that a power limitation is active since an input overvoltage (DC) has been recorded. LIM xxx% = Power reduction percentage Examples: LIM 100% = no power limitation LIM 50% = limitation to 50% of the output nominal power	<ul style="list-style-type: none"> • It is necessary to measure the input voltage inside the inverter with a voltmeter. - If it is higher than the maximum voltage of the operating range, the alarm is genuine and it is necessary to check the configuration of the PV generator. If the voltage has also exceeded the maximum input threshold the inverter could be damaged. - If it is lower than the maximum voltage of the operating range, the alarm is caused by an internal malfunction and it is necessary to contact customer assistance.



Registration on “Registration” website and calculation of second-level password (Service Menu)

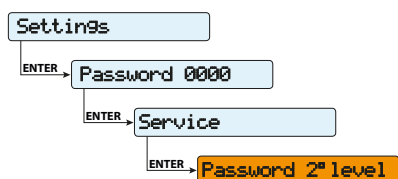

In order to obtain the second-level password needed to access the inverter's service menu, it is necessary to go through the following stages:

Stage 1 - Collection of information relating to the inverter.

Collect the following information relating to each inverter for which you wish to have a password:

- **S/N** - Serial number of the inverter. This information can be found on the label giving the identity details of the inverter or on the display by accessing the “INFORMATION” menu→Serial No.”

The serial number consists of 6 digits (the last 6 in models with a label giving a 10-digit S/N)

- **WK** - Production week. This information can be found on the label giving the identity details of the inverter or on the display by accessing the “INFORMATION” menu→Serial No.”

The production week consists of 4 figures, indicating the week (first 2 digits) and the year of production (last 2 digits)

- **Update Version** - This information is available only for some inverter models and can be found on the display by accessing the menu “INFORMATION→Firmware”.

Stage 2 - Registration on <https://registration.abbsolarinverters.com>

- Go online and access <https://registration.abbsolarinverters.com>
- Set the desired language and click on the specific icon to start registration



- Insert the personal data requested and end the registration stage
- An email will be sent to the email address used with a link to complete the registration process.
- Once the registration process is over, a further email will be sent with the password to access the website.

The password obtained enables access also to the advanced “Installer” mode present on the configuration software for inverters. The configuration software can be downloaded in a specific section of the website <https://registration.abbsolarinverters.com>



Stage 3 - Request for second level password

- Go online and access <https://registration.abbsolarinverters.com>
- Insert the Username (corresponding to the email used during registration) and the Password obtained at the end of Stage 2

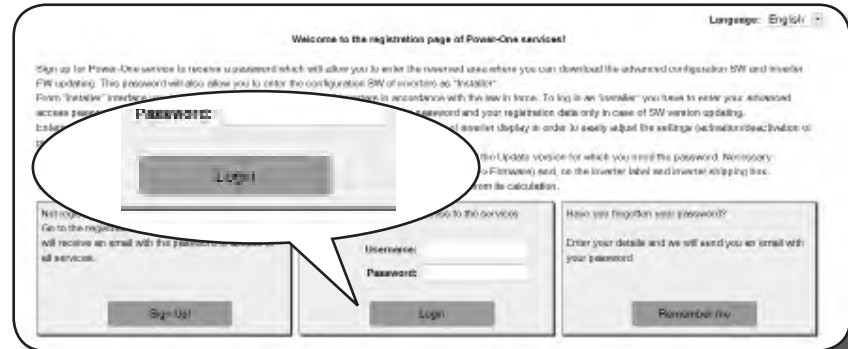

- Access the section dedicated to requesting the second-level password

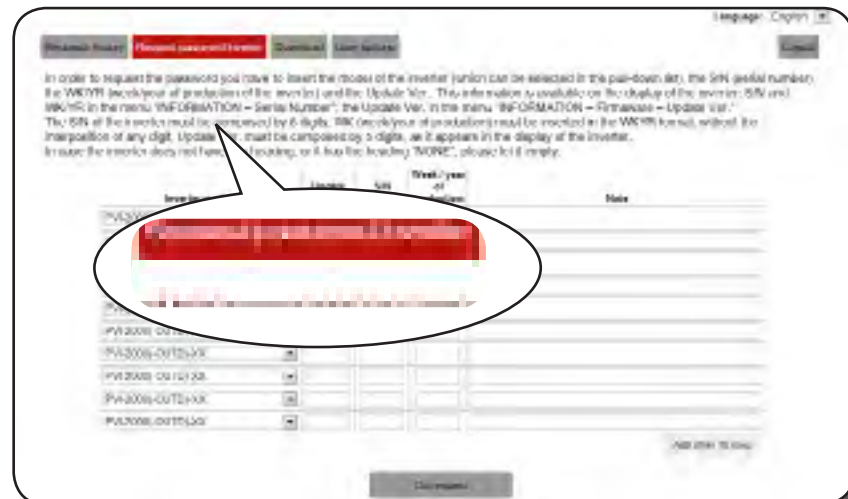

- Choose the inverter model from the drop-down list and insert Update Ver., Serial Number and Week of Production of the inverter which were obtained previously (Stage 1)

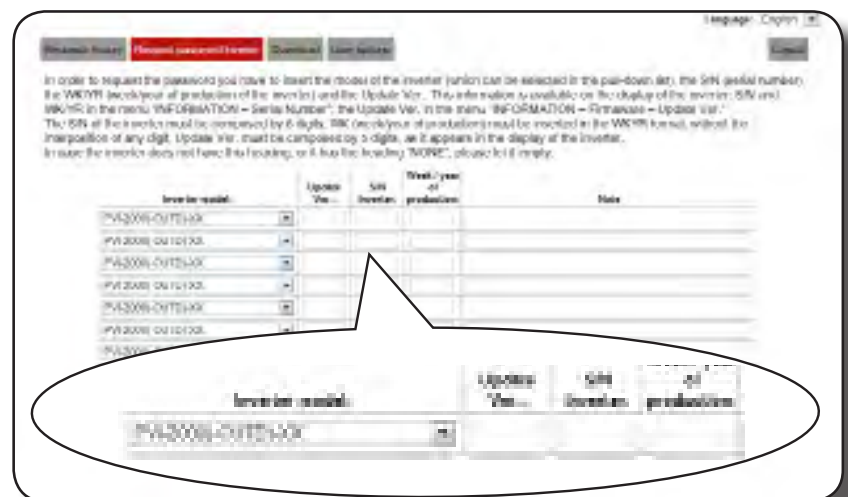

000336BG

- Click on icon to request password.

Inverter model	Update Ver.	S/N Inverter	WCHP year of production	Mail
HW-2014010	F2345	123456	9513	
HW-1010110		991001	9112	
HW-2014010	F1002	964789	4012	
HW-2008-0210100				
HW-2008-0210100				
HW-2008-0210100				
HW-2008-0210100				
HW-2008-0210100				
HW-2008-0210100				
HW-2008-0210100				
HW-2008-0210100				

Should there be an error in inputting data, the fields containing the error will be highlighted in red. If, on the other hand, the data are correct, the passwords will be shown in a new window and at the same time sent to the email address used for registration.



The second-level password enables access to the service menu which allows the inverter's sensitive parameters to be changed. Proceed to changing the aforementioned parameters only when requested by the grid operator or by customer assistance.



Resetting the remaining time for grid standard variation

From the moment a valid grid standard is set and the inverter is switched on, there is a time period of 24 hours available in which modifications to the grid standard setting can be made.



The 24 hours are only counted while the inverter is switched on. Check that the date and time are correctly set. If these settings are incorrect, it may not be possible to access the "Reset Country" menu which allows the timer to be reset.

Once this period has passed, changing the standard will be "blocked" and it will be necessary to carry out the following procedure to reset the remaining time and once again, have 24 hours of operation available in which to select a new grid standard.



You can check how much time remains before the "Country Select" button is blocked, by accessing the menu SYSTEM > SETTINGS > Country Select. > Residual Time.



1. Access the "SYSTEM > SETTINGS" menu by entering the first level password (default **0000**)

2. Access the "Country Select" submenu. > Reset Country" entering the second level password to restore the 24 hours of operation in which it is possible to change the grid standard.



The password required for accessing the "Service" menu can be obtained by registering on the website <https://registration.abbsolarinverters.com>.



Before connecting to the site, make sure you have all the information required to calculate your password: - Inverter model / - Serial Number and Week of Production / - Update field (The "Update field" is only available if the inverter firmware has been previously updated. If not available, leave the field empty when asked for the password). The password is valid for 15 days.



3. After having reset the timer, it will be possible to change the grid standard with the one required in the menu SYSTEM > SETTINGS > Country Select. > Set Std.

Verification of ground leakage

In the presence of anomalies or report of ground fault (where provided), there may be a ground leakage from the PV generator (DC side).

To check this, measure the voltage between the positive pole and ground and between the negative pole (of the PV generator) and ground using a voltmeter whose input accepts a voltage of at least 1000 Volts.

Behaviour of a system without leakage

Due to the capacitive effect of the PV generator, during the first moments that the voltmeter is connected between one of the two poles and ground, it will measure a voltage of about $V_{oc}/2$, which will tend to stabilize to around 0V if there is no ground leakage, as shown in the graph below:

The internal resistance of the voltmeter tends to zero the voltage present on the PV generator due to the capacitive effect.

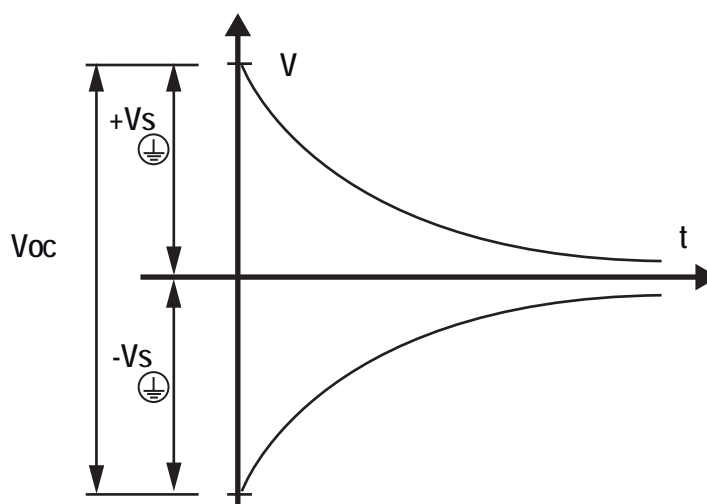

How to make the measurement:

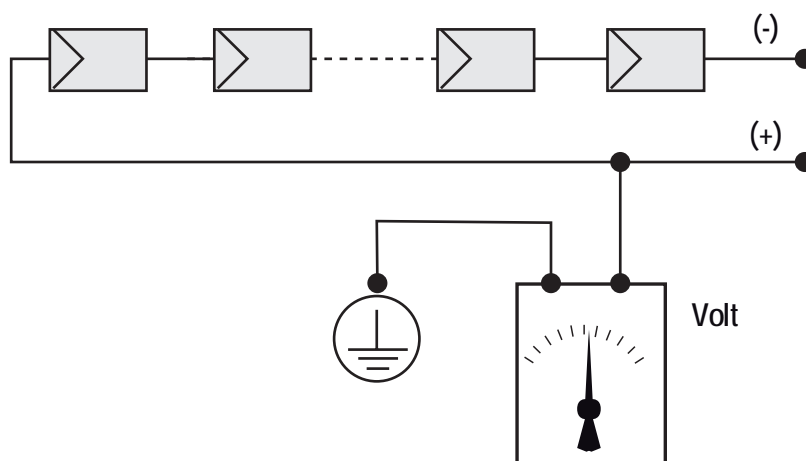

Behaviour of a system with leakage

If the voltage measured between one of the two poles and ground does not tend to 0V and stabilizes on a value, there is a ground leakage from the PV generator.

Example: When the measurement is made between positive pole and ground, a voltage of 200V is measured.

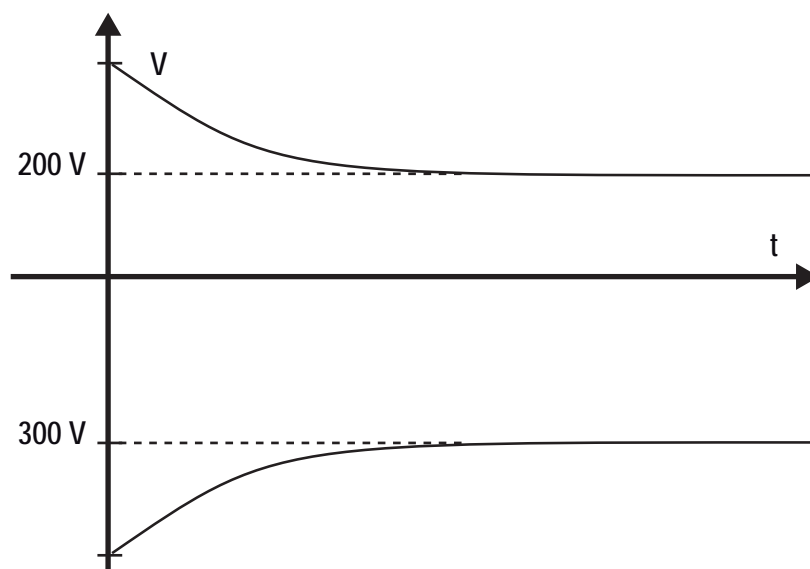

This means that if the system is made up of 10 modules in series and each one supplies 50V, the leakage can be located between the 4th and 5th PV module.

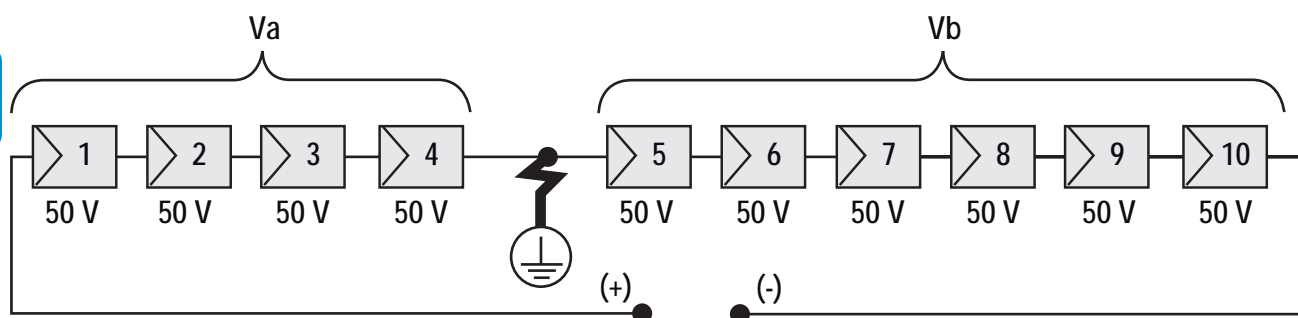

V_a = voltage measured between + pole and \oplus = 200V

V_b = voltage measured between - pole and \oplus = 300V

In all measurements with \oplus , the ground of the inverter is indicated.

Measuring the insulation resistance of the PV generator.

To measure the insulation resistance of the PV generator compared to ground \oplus , the two poles of the PV generator must be short-circuited (using a suitably sized selector).

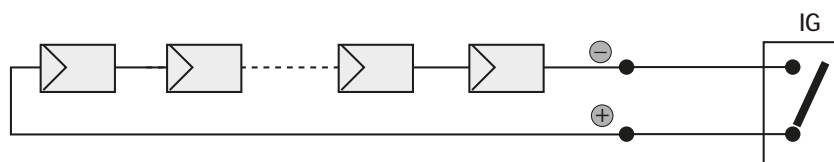

Once the short-circuit has been made, measure the insulation resistance (Riso) using a megohmmeter positioned between the two shorted poles and ground (of the inverter).

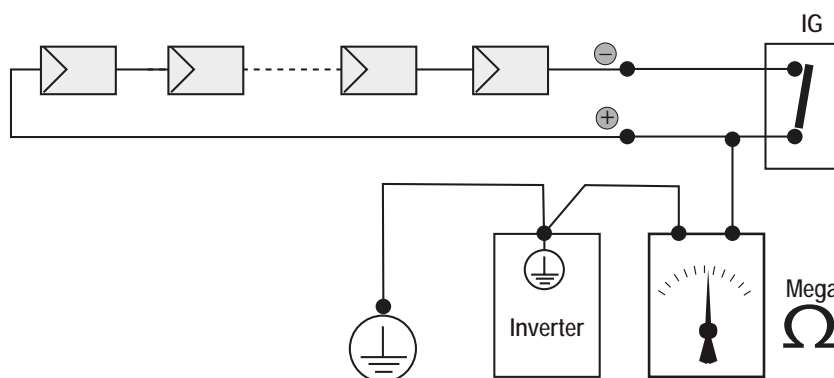

MODELS - TL (without insulation transformer). If the measured insulation resistance (Riso) is less than 500 MOhm, the inverter may not connect to the grid because of low insulation of the PV generator to ground.

MODELS - I (with insulation transformer). If the measured insulation resistance (Riso with floating input poles compared to ground or QF=1 with grounding of one of the two inlet poles) is lower than 0.2 MOhm, the inverter will not connect to the grid due to low insulation of the PV generator to ground.



The insulation resistance can be affected by the environmental conditions the PV generator is in (E.g.: PV modules wet from damp or rain), and therefore the measurement must be made immediately after the anomaly is detected

Storage and dismantling

Storage of the equipment or prolonged stoppage

If the equipment is not used immediately or is stored for long periods, check that it is correctly packed and contact **ABB** for storage instructions. The equipment must be stored in well-ventilated indoor areas having no characteristics that could damage the components of the equipment.

Restarting after a long or prolonged stop requires a check and, in some cases, the removal of oxidation and dust that will also have settled inside the equipment if not suitably protected.

Dismantling, decommissioning and disposal

ABB IS NOT responsible for the disposal of the equipment: displays, cables, batteries, accumulators, etc., and therefore the customer must dispose of these substances, which are potentially harmful to the environment, in accordance with the regulations in force in the country of installation.

If the equipment is dismantled, always comply with the regulations in force in the country of destination during disposal of its component parts and in any case avoid causing any kind of pollution.

Dispose of the various types of materials making up parts of the equipment in disposal facilities suitable for such purpose.

Table: disposal of components

COMPONENT.....	CONSTRUCTION MATERIAL
Frame, brackets, supports	Arc-welded steel FE37
Casing or covers	ABS, plastic
Coating.....	RAL
Gaskets and seals	Rubber / Teflon / Viton
Electrical cables	Copper / Rubber
Cable trays	Polyethylene / Nylon
Back-up battery	Nickel / Lead/ Lithium