

Modular contactors AC-1, AC-coil



BZ326472



BZ326470

Schrack-Info

- Compact modular design , mounting to DIN-rail TS35, for covers with slot dimension 45mm
- With optical position indicator
- Types with AC-coil low humming
- Types 25A, 40A and 63A can be retrofitted by lateral auxiliary contact

Dimensions (mm)

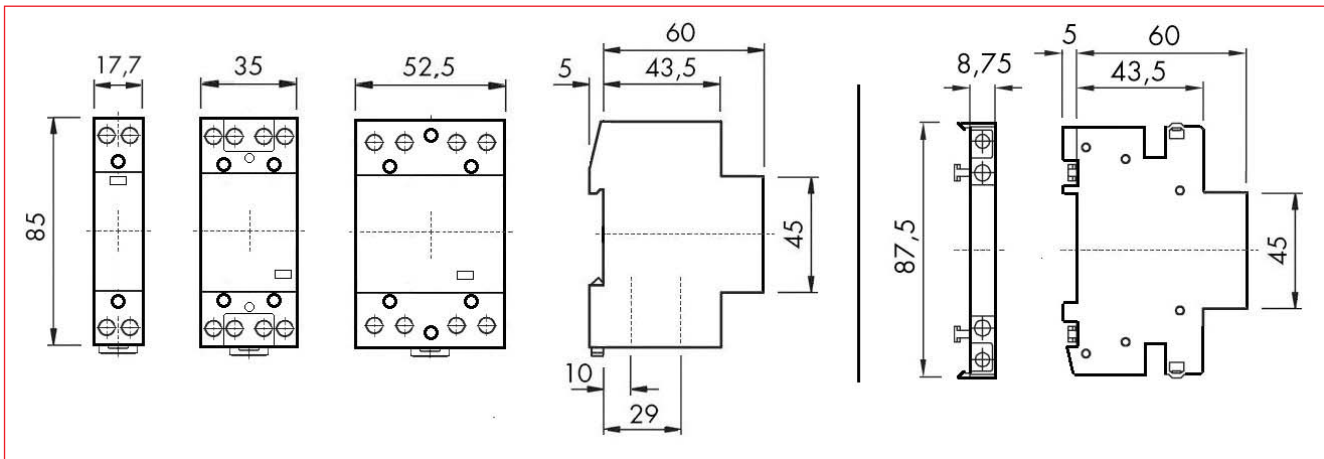

Circuit Diagrams

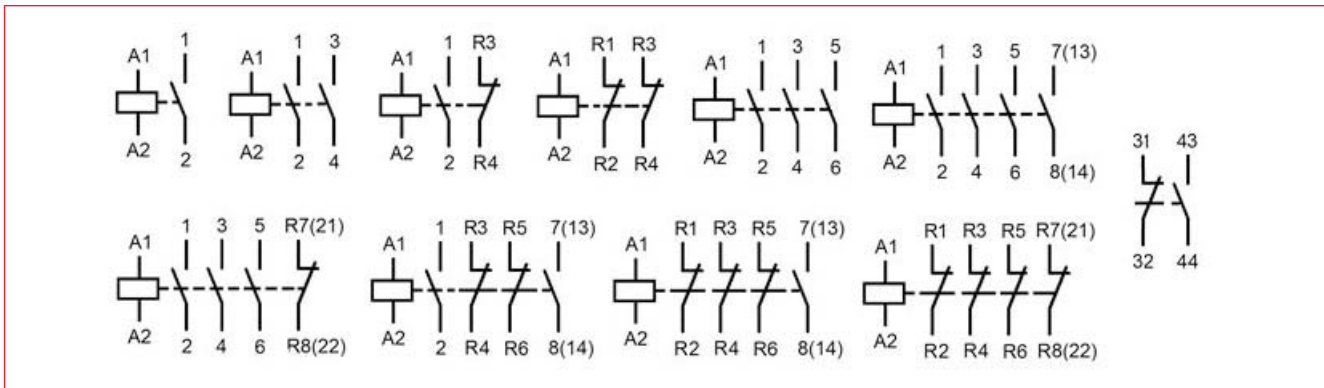

Modular contactors AC-1, AC-coil

Type	2-pole				4-pole			BZ326441--	BZ326470--		
	20A	25A	40A	63A	25A	40A	63A				
Main contacts ^{5) 6) 7)}											
Rated insulation voltage U_i	V~	440 ²⁾	440 ²⁾	440 ²⁾	440 ²⁾	440 ²⁾	440 ²⁾	690 ¹⁾	440 ²⁾		
Rated operational voltage U_e	V~	440	440	440	440	440	440	690	440		
Switching frequency	AC1, AC3	1/h	300	300	600	600	600	600	600		
Mechanical endurance		$S \times 10^6$	1	1	1	1	1	5	1		
Utilization category AC1											
Rated operational current I_e ($=I_{th}$)											
open... at	60°C	A	20	25	40	63	25	40	63	20	-
Endurance of main contacts		$S \times 10^6$	0,1	0,1	0,1	0,1	0,1	0,1	0,1	0,2	-
Minimum switching voltage		V/mA	24/100	24/100	24/100	24/100	24/100	24/100	24/100	24/100	17/5
Short time current	10s-current	A	72	72	216	240	72	216	240	96	-
Power loss per pole/ I_e /AC1		W	2	3	3	7	2	3	7	1	0,5
Utilization category AC3 / AC7b											
Switching of slipping or squirrel-cage motors											
Rated operational current I_e		A	-	-	-	-	9	27	30	12	-
Rated power of motor	220V	kW	-	-	-	-	2,2	7,5	8	3	-
50-60Hz	230-240V	kW	-	-	-	-	2,5	8	8,5	3	-
	380-415V	kW	-	-	-	-	4	12,5	15	4	-
2-pole motors	230V	kW	1,1	1,3	2,6	5	-	-	-	-	-
Endurance of main contacts		$S \times 10^6$	0,15	0,15	0,15	0,15	0,15	0,15	0,15	0,9	-
Power consumption of coil											
AC-operated	closing	VA	7-9	7-9			20 - 25	33 - 45	33 - 45	3 - 3,5	-
	closed	VA	2,2 - 4,2	2,2 - 4,2	5-7	5-7	4-6	6-8	6-8	3 - 3,5	-
		W	0,8 - 1,6	0,8 - 1,6			1,5 - 2,5	2,6	2,6	3 - 3,5	-
Operating range of coil											
in multiples of control voltage U_c (-40°C up to +40°C)			0,85 - 1,1	0,85 - 1,1	0,85 - 1,1	0,85 - 1,1	0,85 - 1,1	0,85 - 1,1	0,85 - 1,1	0,85 - 1,1	-

1) Valid for: earthed-neutral systems, overvoltage category I to IV, pollution degree 3 (standard-industry): $U_{imp} = 6kV$

2) Valid for: earthed-neutral systems, overvoltage category I to III, pollution degree 3 (standard-industry): $U_{imp} = 4kV$











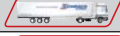



















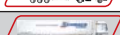

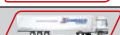
3) Maximum cable cross-section with prepared conductor

5) rated frequency 50/60Hz

6) Max. occ. switching overvoltage $< 4kV$

7) Duty cycle: 100%

Modular contactors AC-1, AC-coil

DESCRIPTION	AVAILABLE	ORDER NO.
AC-coil 24V		
20A, 1 NO/24 VAC		BZ326486
20A, 1 NO, 1 NC/24 V		BZ326421
20A, 2 NO/24 V		BZ326453
25 A, 1 NO/24 VAC		BZ326490
25 A, 1 NO, 1 NC/24 VAC		BZ326476
25 A, 1 NO, 3 NC/24 VAC		BZ326464
25 A, 2 NO/24 VAC		BZ326474
25 A, 2 NC/24 VAC		BZ326480
25 A, 2 NO, 2 NC/24 VAC		BZ326482
25 A, 3 NO, 1 NC/24 VAC		BZ326462
25 A, 4 NO/24 VAC		BZ326460
25 A, 4 NC/24 VAC		BZ326483
40 A, 2 NO, 2 NC/24 VAC		BZ326488
40 A, 3 NO, 1 NC/24 VAC		BZ326487
40 A, 4 NO/24 V		BZ326443
40 A, 4 NC/24 VAC		BZ326489
63 A, 2 NO, 2 NC/24 VAC		BZ326456
63 A, 3 NO, 1 NC/24 VAC		BZ326455
63 A, 4 NO/24 V		BZ326445
63 A, 4 NC/24 VAC		BZ326458
AC-coil 230V		
20A, 1 NO/230 VAC		BZ326471
20A, 1 NO, 1 NC/230 V		BZ326438
20A, 2 NO/230 V		BZ326437
20A, 2 NC/230 V		BZ326439
20A, 4 NO/230 V		BZ326441
25 A, 1 NO/230 VAC		BZ326473
25 A, 1 NO, 1 NC/230 VAC		BZ326479
25 A, 1 NO, 3 NC/230 VAC		BZ326465
25 A, 2 NO/230 VAC		BZ326475
25 A, 2 NC/230 VAC		BZ326481
25 A, 2 NO, 2 NC/230 VAC		BZ326472
25 A, 3 NO, 1 NC/230 VAC		BZ326463
25 A, 4 NO/230 VAC		BZ326461
25 A, 4 NC/230 VAC		BZ326467
40 A, 2 NO, 2 NC/230 VAC		BZ326466
40 A, 3 NO/230 VAC		BZ326468
40 A, 3 NO, 1 NC/230 VAC		BZ326454
40 A, 4 NO/230 V		BZ326442
40 A, 4 NC/230 VAC		BZ326459
63 A, 2 NO, 2 NC/230 VAC		BZ326457
63 A, 3 NO, 1 NC/230 V		BZ326452
63 A, 4 NO/230 V		BZ326444
63 A, 4 NC/230 VAC		BZ326469
Accessories		
Auxiliary Contact 1NO+1NC 3A		BZ326470



Order no. blue: on stock, usually ready for delivery on the day of order

Скачано с сайта интернет магазина <https://axiomplus.com.ua>