

CONNECTING COMPETENCE.

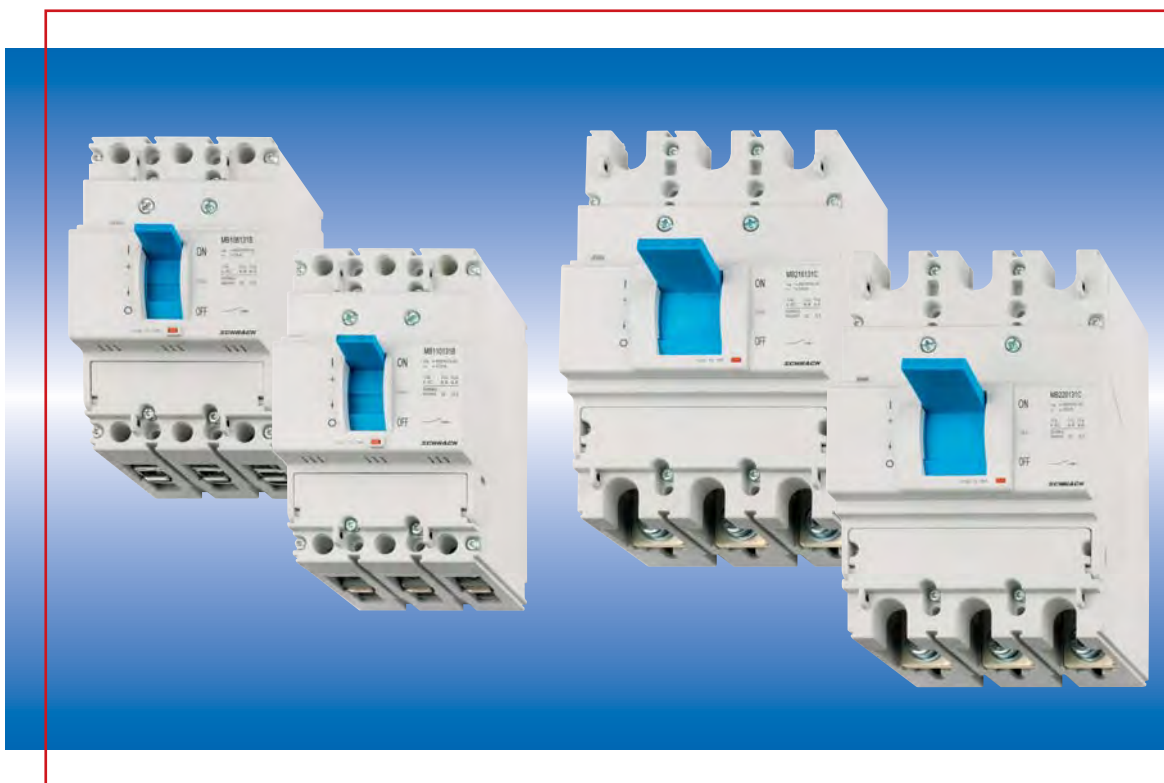

CIRCUIT BREAKERS MB

CIRCUIT BREAKERS MB1 16 TO 125A

CIRCUIT BREAKERS MB2 125 TO 250A

MB1 AND MB2 ACCESSORIES

OPTIMUM AND EFFICIENT PROTECTION FOR EVERY APPLICATION COMPACT – SIMPLE – SAFE

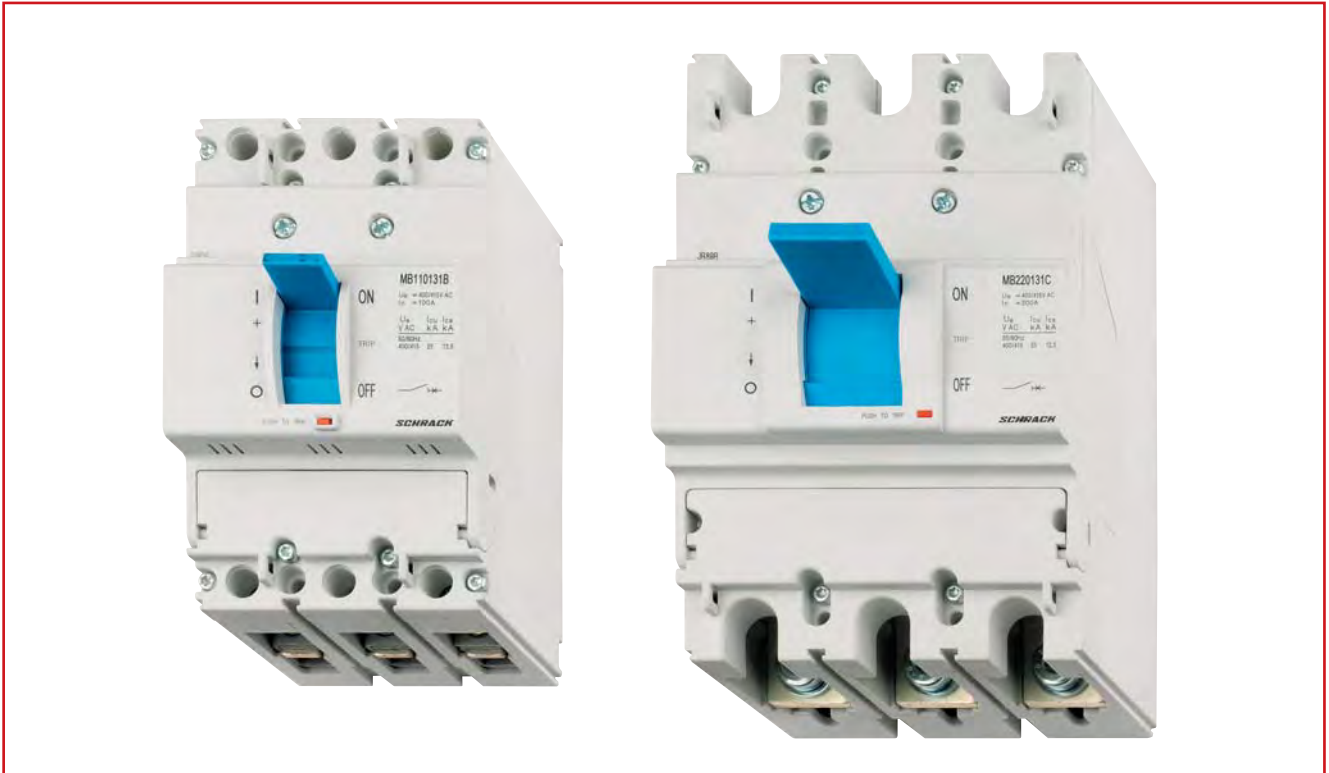

THREE ADVANTAGES FOR YOUR BENEFIT

• COMPACT

Unbeatable when it comes to saving space: In the range of circuit breakers, the MB1 and MB2 are among the slimmest in their class and can therefore use the valuable distribution space most efficiently, regardless of whether they are used for energy sub-distribution or as a protection for incoming power in residential or functional buildings.

• SIMPLE

Easy to handle: For a fast starting are thermal and magnetic tripping values already fixed. The MB series is absolutely easy to handle and allows for quick installation when executing your jobs.

• SAFE

Schrack's switchgears have a worldwide reputation for being the benchmark in low-voltage power distribution. Schrack's quality protects people and assets against short-circuits and overload, with the MB series being designed for the 16 to 250 A range in sub-distribution.

STANDARDS

In complying with the IEC/EN 60947-2 standards and pollution degree III (IEC/EN 60947) we not only ensure the material but also the immaterial values of the MB circuit breaker series. And with our MB series, we also show consideration for the environment as these circuit breakers conform to the RoHS directives and can be recycled to a large extent. And last but not least - the stylish outfit of the MB series in the distinctive Schrack design makes these products attractive not only from a technical but also from an aesthetic point of view.

For more information please turn to technical data page.

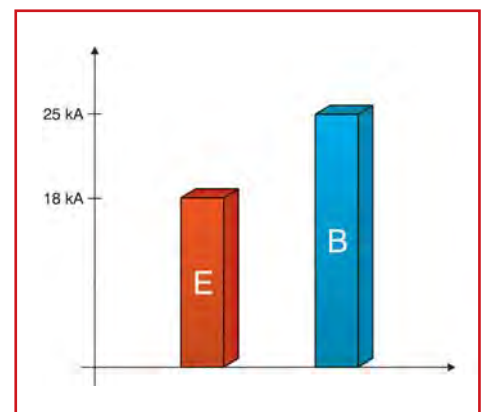

TYPE KEY MB1

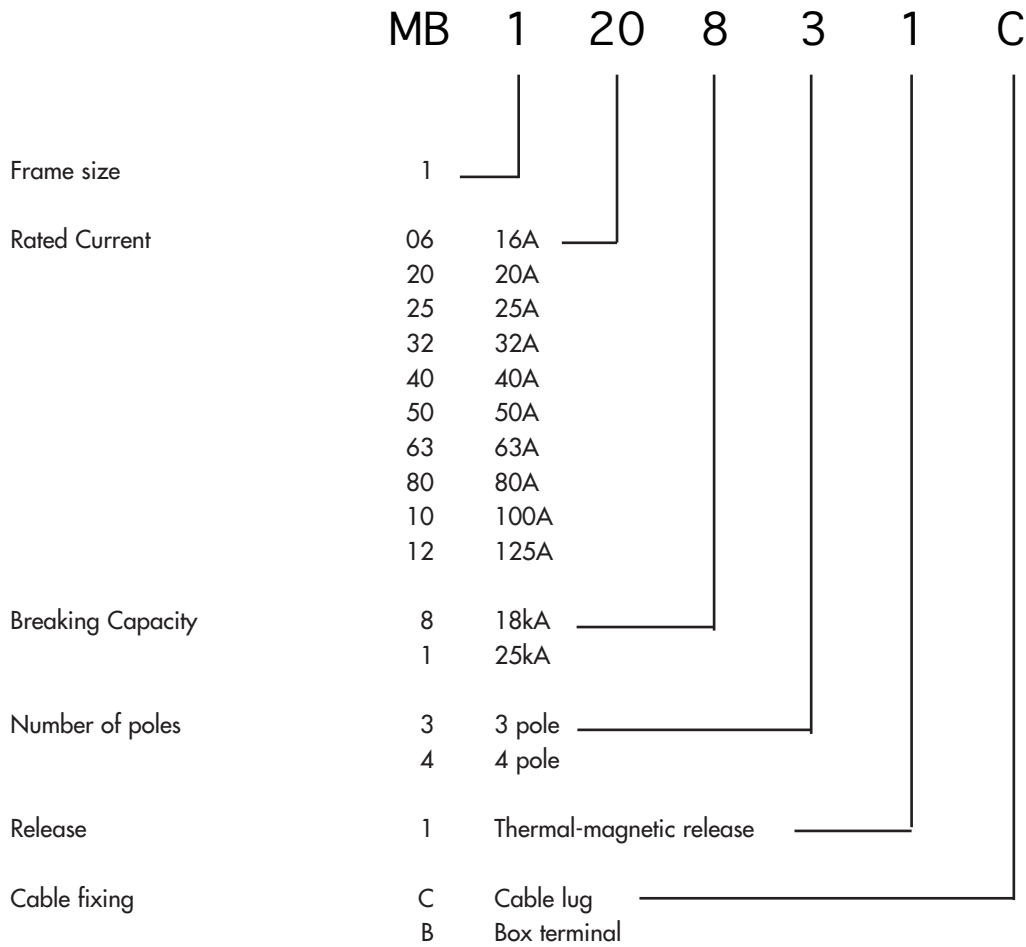

example: MB120831C = MCCB 20A, 18kA, 3pole for cable lug with thermal-magnetic release

TYPE KEY MB2

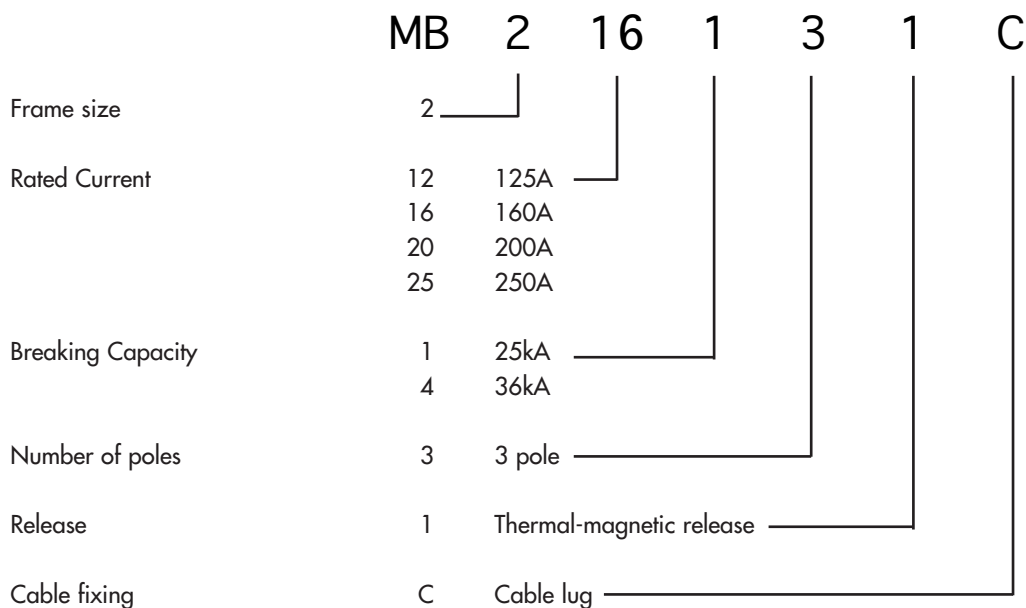

example: MB216131C = MCCB 160A, 25kA, 3pole for cable lug with thermal-magnetic release

TABLE OF CONTENT MB1

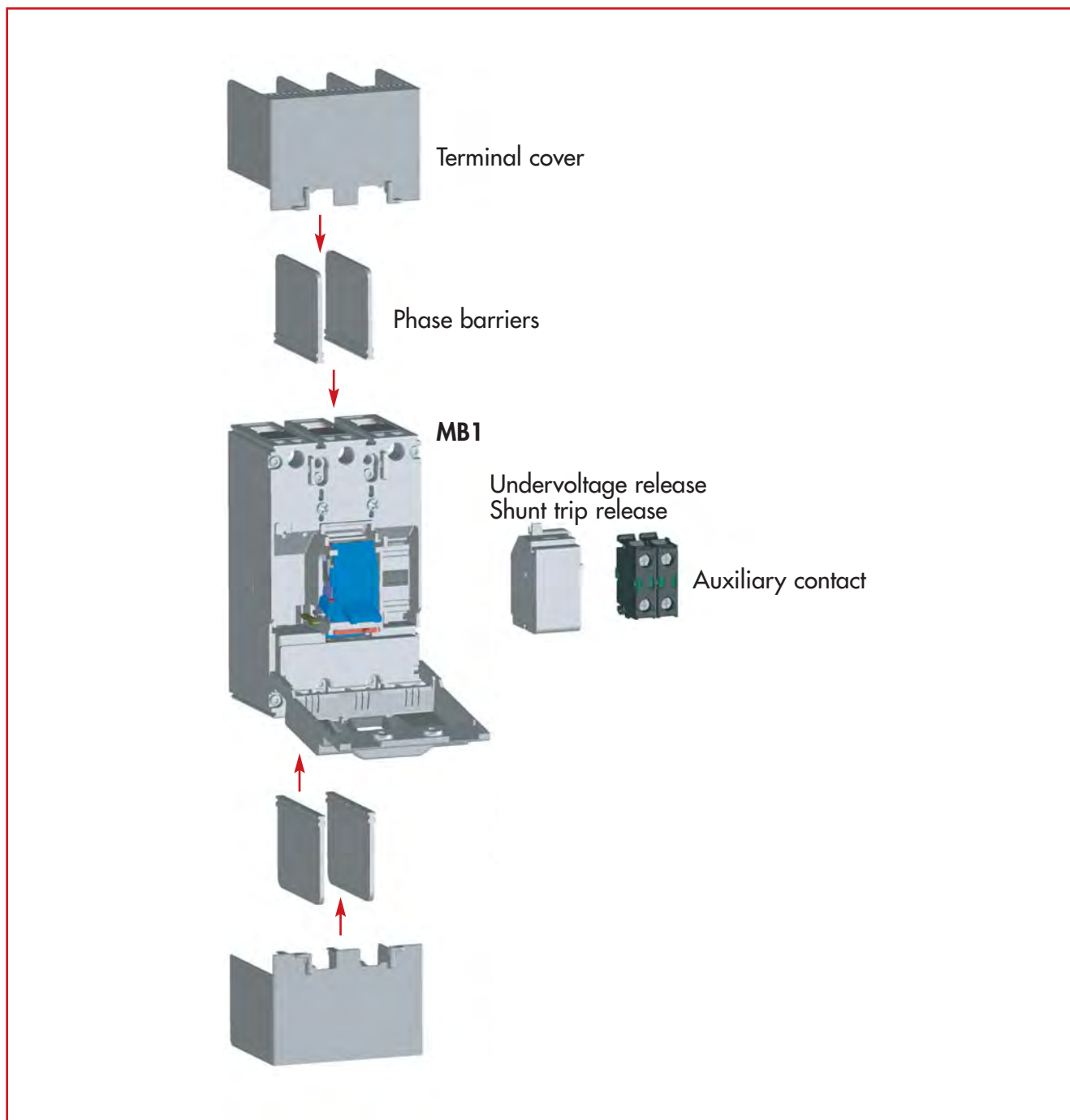

CONCENTRATED TECHNOLOGY WITH A LONG LIFESPAN

The MB1 provides protection with rated currents **up to 125 A** and **25 kA** breaking capacity, despite its light weight and slim width of only 25 mm per pole. The star within the circuit breaker family, is available as a **3 or 4-pole** device. For a fast starting are thermal and magnetic tripping values already fixed by Schrack. And it has an extremely long lifespan of up to 10,000 mechanical operating cycles. In addition, thanks to its terminal cover, the MB1 features an IP 10 degree of protection.

MB1 – SMALL IS POWERFUL



MB-C



MB-B

MULTIPLE MOUNTING OPTIONS

Upside-down or horizontal? It is up to you how you wish to mount the MB1. But regardless of the mounting position and the side you choose for the supply of power, it will always provide the full protective function.

CABLE FIXING: CABLE LUG AND BOX TERMINAL

The proven **cable lug** with M6 screws **and the box terminal technology** for quick and easy mounting (MB...-B): both are included in the **standard range** of products.

SOLUTIONS MADE TO MEASURE

Remote tripping, signalling the switching status or under-voltage releasing in case of security relevant applications - all of this is easy to manage for the MB1. Thanks to the comprehensive range of accessories, the MB1 will not only be the perfect match for standard applications, but also the ideal solution for individual handling requirements.

Upon request the MB1 is also available with a rotary handle (for direct mounting or door coupling).

CHARACTERISTICS / FEATURES

- Rated current: 16 A up to 125 A
- Breaking Capacity: 18, 25 kA
- Cable fixing: Cable lug M6 or Box Terminal (MB...-B)
- Available poles: 3pole, 4poles
- Rated Voltage: 400/415V, 50/60Hz
- 3-Position lever: Off - Trip - ON
- Electrical Supply: Line or Load-Side

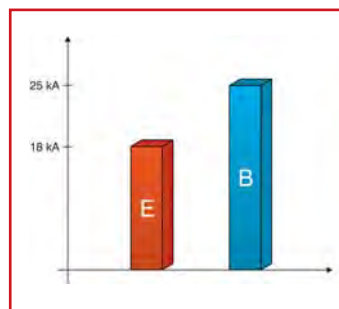

■ CIRCUIT BREAKER 3 POLE UP TO 125A WITH THERMAL MAGNETIC RELEASE TYPES MB1E-A, MB1B-A



■ SCHRACK INFO

- For system and line protection
- Box terminals and screw terminals
- Breaking capacity 18 / 25 kA at 415 V 50/60 Hz
- Meets IEC/EN 60947-2

RATED CURRENT / BREAKING CAPACITY	SHORT CIRCUIT-RELEASE (A)	TYPE	ORDER NO.
3 POLE (ECONOMIC BREAKING CAPACITY) 18 kA – CABLE LUG			
16 A/18 kA	256 – 384	MB1E-A16C	MB106831C
20 A/18 kA	256 – 384	MB1E-A20C	MB120831C
25 A/18 kA	320 – 480	MB1E-A25C	MB125831C
32 A/18 kA	320 – 480	MB1E-A32C	MB132831C
40 A/18 kA	320 – 480	MB1E-A40C	MB140831C
50 A/18 kA	480 – 720	MB1E-A50C	MB150831C
63 A/18 kA	480 – 720	MB1E-A63C	MB163831C
80 A/18 kA	800 – 1200	MB1E-A80C	MB180831C
100 A/18 kA	800 – 1200	MB1E-A100C	MB110831C
125 A/18 kA	800 – 1200	MB1E-A125C	MB112831C
3 POLE (ECONOMIC BREAKING CAPACITY) 18 kA – BOX TERMINAL			
16 A/18 kA	256 – 384	MB1E-A16B	MB106831B
20 A/18 kA	256 – 384	MB1E-A20B	MB120831B
25 A/18 kA	320 – 480	MB1E-A25B	MB125831B
32 A/18 kA	320 – 480	MB1E-A32B	MB132831B
40 A/18 kA	320 – 480	MB1E-A40B	MB140831B
50 A/18 kA	480 – 720	MB1E-A50B	MB150831B
63 A/18 kA	480 – 720	MB1E-A63B	MB163831B
80 A/18 kA	800 – 1200	MB1E-A80B	MB180831B
100 A/18 kA	800 – 1200	MB1E-A100B	MB110831B
125 A/18 kA	800 – 1200	MB1E-A125B	MB112831B
3 POLE (BASIC BREAKING CAPACITY) 25 kA – CABLE LUG			
16 A/25 kA	256 – 384	MB1B-A16C	MB106131C
20 A/25 kA	256 – 384	MB1B-A20C	MB120131C
25 A/25 kA	320 – 480	MB1B-A25C	MB125131C
32 A/25 kA	320 – 480	MB1B-A32C	MB132131C
40 A/25 kA	320 – 480	MB1B-A40C	MB140131C
50 A/25 kA	480 – 720	MB1B-A50C	MB150131C
63 A/25 kA	480 – 720	MB1B-A63C	MB163131C
80 A/25 kA	800 – 1200	MB1B-A80C	MB180131C
100 A/25 kA	800 – 1200	MB1B-A100C	MB110131C
125 A/25 kA	800 – 1200	MB1B-A125C	MB112131C
3 POLE (BASIC BREAKING CAPACITY) 25 kA – BOX TERMINAL			
16 A/25 kA	256 – 384	MB1B-A16B	MB106131B
20 A/25 kA	256 – 384	MB1B-A20B	MB120131B
25 A/25 kA	320 – 480	MB1B-A25B	MB125131B
32 A/25 kA	320 – 480	MB1B-A32B	MB132131B
40 A/25 kA	320 – 480	MB1B-A40B	MB140131B
50 A/25 kA	480 – 720	MB1B-A50B	MB150131B
63 A/25 kA	480 – 720	MB1B-A63B	MB163131B
80 A/25 kA	800 – 1200	MB1B-A80B	MB180131B
100 A/25 kA	800 – 1200	MB1B-A100B	MB110131B
125 A/25 kA	800 – 1200	MB1B-A125B	MB112131B

■ CIRCUIT BREAKER 4 POLE UP TO 125A WITH THERMAL MAGNETIC RELEASE TYPES MB1E-A, MB1B-A



■ SCHRACK INFO

- For system and line protection
- Box terminals and screw terminals
- Breaking capacity 18 / 25 kA at 415 V 50/60 Hz
- Meets IEC/EN 60947-2

RATED CURRENT / BREAKING CAPACITY	SHORT CIRCUIT-RELEASE (A)	TYPE	ORDER NO.
4 POLE (ECONOMIC BREAKING CAPACITY) 18 kA – CABLE LUG			
16 A/18 kA	256 – 384	MB1E-A16C	MB106841C
20 A/18 kA	256 – 384	MB1E-A20C	MB120841C
25 A/18 kA	320 – 480	MB1E-A25C	MB125841C
32 A/18 kA	320 – 480	MB1E-A32C	MB132841C
40 A/18 kA	320 – 480	MB1E-A40C	MB140841C
50 A/18 kA	480 – 720	MB1E-A50C	MB150841C
63 A/18 kA	480 – 720	MB1E-A63C	MB163841C
80 A/18 kA	800 – 1200	MB1E-A80C	MB180841C
100 A/18 kA	800 – 1200	MB1E-A100C	MB110841C
125 A/18 kA	800 – 1200	MB1E-A125C	MB112841C
4 POLE (ECONOMIC BREAKING CAPACITY) 18 kA – BOX TERMINAL			
16 A/18 kA	256 – 384	MB1E-A16B	MB106841B
20 A/18 kA	256 – 384	MB1E-A20B	MB120841B
25 A/18 kA	320 – 480	MB1E-A25B	MB125841B
32 A/18 kA	320 – 480	MB1E-A32B	MB132841B
40 A/18 kA	320 – 480	MB1E-A40B	MB140841B
50 A/18 kA	480 – 720	MB1E-A50B	MB150841B
63 A/18 kA	480 – 720	MB1E-A63B	MB163841B
80 A/18 kA	800 – 1200	MB1E-A80B	MB180841B
100 A/18 kA	800 – 1200	MB1E-A100B	MB110841B
125 A/18 kA	800 – 1200	MB1E-A125B	MB112841B
4 POLE (BASIC BREAKING CAPACITY) 25 kA – CABLE LUG			
16 A/25 kA	256 – 384	MB1B-A16C	MB106141C
20 A/25 kA	256 – 384	MB1B-A20C	MB120141C
25 A/25 kA	320 – 480	MB1B-A25C	MB125141C
32 A/25 kA	320 – 480	MB1B-A32C	MB132141C
40 A/25 kA	320 – 480	MB1B-A40C	MB140141C
50 A/25 kA	480 – 720	MB1B-A50C	MB150141C
63 A/25 kA	480 – 720	MB1B-A63C	MB163141C
80 A/25 kA	800 – 1200	MB1B-A80C	MB180141C
100 A/25 kA	800 – 1200	MB1B-A100C	MB110141C
125 A/25 kA	800 – 1200	MB1B-A125C	MB112141C
4 POLE (BASIC BREAKING CAPACITY) 25 kA – BOX TERMINAL			
16 A/25 kA	256 – 384	MB1B-A16B	MB106141B
20 A/25 kA	256 – 384	MB1B-A20B	MB120141B
25 A/25 kA	320 – 480	MB1B-A25B	MB125141B
32 A/25 kA	320 – 480	MB1B-A32B	MB132141B
40 A/25 kA	320 – 480	MB1B-A40B	MB140141B
50 A/25 kA	480 – 720	MB1B-A50B	MB150141B
63 A/25 kA	480 – 720	MB1B-A63B	MB163141B
80 A/25 kA	800 – 1200	MB1B-A80B	MB180141B
100 A/25 kA	800 – 1200	MB1B-A100B	MB110141B
125 A/25 kA	800 – 1200	MB1B-A125B	MB112141B

TABLE OF CONTENT MB2

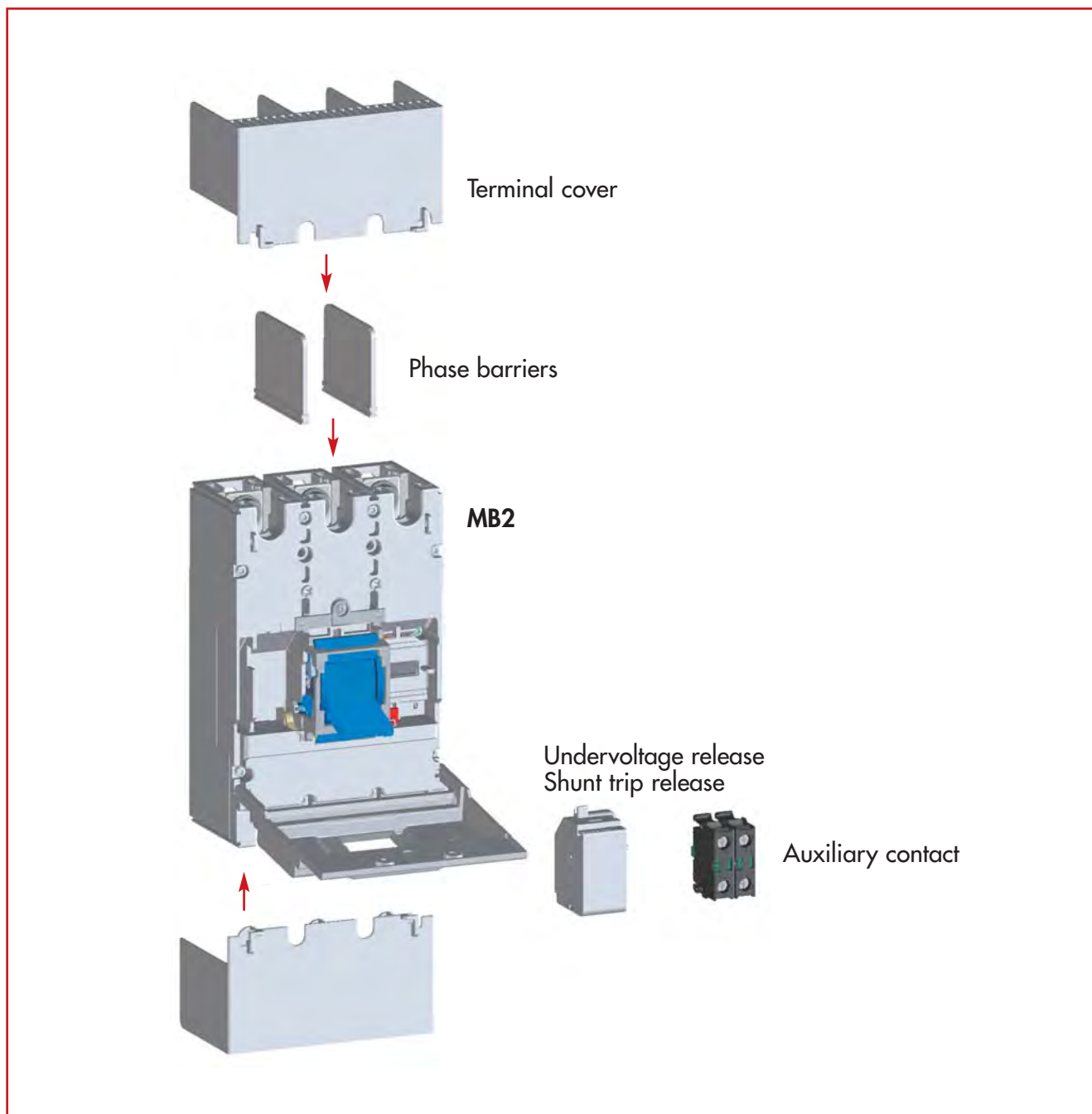

TECHNOLOGY BROUGHT TO THE POINT

Schrack's new MB2 keeps a watchful eye on **rated currents** ranging from **125 to 250 A** and a breaking capacity of **25 kA and 36 kA**: it impresses especially with its functionality and robust design. The **3-pole** version (size W x D x H: 105 x 91.5 x 165 mm) with a lifespan of 8,000 mechanical operating cycles makes it a powerful protective device in a compact format.

MB2 – EXCELLENT PROTECTION FOR HIGH-RATED CURRENT REQUIREMENTS



MB2

PERFECT ADJUSTMENT TO ANY ENVIRONMENT

Standard position, horizontal or upside-down: you can select the mounting position just as freely as the side for the incoming power supply.

CONVENTIONAL CONNECTION VIA CABLE LUG

In line with the common practice for this type of rated current, the connection is established through a **cable lug** and M8 screws.

ACCESSORIES IN SCHRACK STYLE

Upon request and in our usual manner, we provide clever accessories such as auxiliary contacts, shunt trip releases, under-voltage releases or terminal covers.

The MB2 is a specialist in the higher range of rated current and offers everything you could want in terms of reliability, easy handling and compact design!

CHARACTERISTICS / FEATURES

Rated current: 125 A up to 250 A

Breaking Capacity: 25 kA, 36 kA

Cable fixing: Cable lug M8

Available poles: 3pole

Rated Voltage: 400/415V, 50/60Hz

3-Position lever: Off - Trip - ON

Electrical Supply: Line or Load-Side

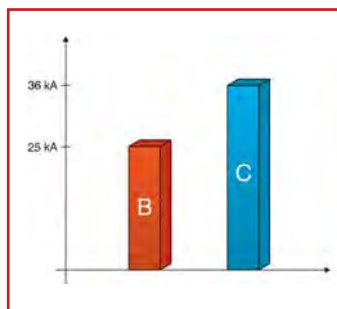

■ CIRCUIT BREAKER 3 POLE UP TO 250A WITH THERMAL MAGNETIC RELEASE TYPES MB2B-A, MB2C-A







■ SCHRACK INFO





- For system and line protection
- Screw terminals
- Breaking capacity 25 / 36 kA at 415 V 50/60 Hz
- Meets IEC/EN 60947-2

RATED CURRENT / BREAKING CAPACITY	SHORT CIRCUIT-RELEASE (A)	TYPE	ORDER NO.
3 POLE (BASIC BREAKING CAPACITY) 25 kA			
125 A/25 kA	1400...2100	MB2B-A125C	MB212131C
160 A/25 kA	1400...2100	MB2B-A160C	MB216131C
200 A/25 kA	1400...2100	MB2B-A200C	MB220131C
250 A/25 kA	1400...2100	MB2B-A250C	MB225131C
3 POLE (COMFORT BREAKING CAPACITY) 36 kA			
125 A/36 kA	1400...2100	MB2C-A125C	MB212431C
160 A/36 kA	1400...2100	MB2C-A160C	MB216431C
200 A/36 kA	1400...2100	MB2C-A200C	MB220431C
250 A/36 kA	1400...2100	MB2C-A250C	MB225431C

MB1 – ACCESSORIES

DESCRIPTION	ORDER NO.	STD. PACK
Auxiliary contacts		
 1 NO	MM216376	20
1 NC	MM216378	20
Phase barrier		
	MB190001	1
Undervoltage release		
 230-240VAC	MB19U230	1
400-415VAC	MB19U400	1
Shunt trip release		
 230-240VAC	MB19A230	1
400-415VAC	MB19A400	1
Terminal cover		
 for 3-pole MB	MB190003	1
for 4-pole MB	MB190004	1

MB2 – ACCESSORIES

DESCRIPTION	ORDER NO.	STD. PACK
Auxiliary contacts		
 1 NO	MM216376	20
1 NC	MM216378	20
Phase barrier		
	MB190001	1
Undervoltage release		
 230-240VAC	MB29U230	1
Shunt trip release		
 230-240VAC	MB29A230	1
Terminal cover		
	MB290003	1

TECHNICAL DATA MB1, MB2

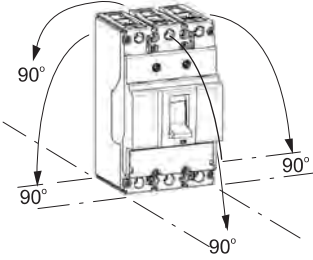
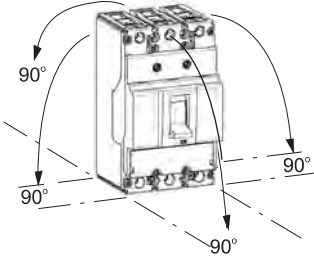
		Rated current max. 125 A MB1	Rated current max. 250 A MB2
Mechanical specifications			
Standards		IEC/EN 60947-2	IEC/EN 60947-2
Number of poles		3, 4	3
Device width	mm	3-pole: 75, 4-pole: 100	3-pole: 105
Frame size	mm	45	45
Socket size	mm	130	165
Device depth	mm	84.7	91,5
Terminals		Lift terminal, ring tongue connector	ring tongue connector
Terminal capacity lift terminal	mm ²	rigid (solid/stranded) and flexible wire (2.5 - 50)	-
Terminal capacity ring tongue	mm	Diameter: max. 15	Diameter: max. 24
Busbar thickness	mm	max. 8	max. 8
Terminal screw		M6 (Pozidriv PZ2)	M8
Terminal torque	Nm	max. 4	max. 14
Degree of Protection (DIN VDE 0470)		Built-in behind panel IP40	Built-in behind panel IP40
Climatic conditions		acc. to IEC 68-2 (25..55°C / 90..95% RH)	acc. to IEC 68-2 (25..55°C/90..95% RH)
Ambient temperature			
Storage	°C	-35 ... +85	-35 ... +85
Operation	°C	-25 ... +70	-25 ... +70
Mounting positions		Vertical and 90° in all directions	Vertical and 90° in all directions
			
Protection System			
Enclosures		With insulating surround: IP40	With insulating surround: IP40
Number of mechanical operating cycles		> 10.000	> 8.0000
Pollution degree		3	3
Electrical specifications			
Rated operational voltage	U_e	V AC 400 / 415, 50/60 Hz	400 / 415, 50/60 Hz
Rated current	I_n	A 16, 20, 25, 32, 40, 50, 63, 80, 100, 125	125, 160, 200, 250
Rated impulse withstand voltage	U_{imp}	V 6000 (1.2/50 µsec)	6000 (1.2/50 µsec)
Overtoltage category		III	III
Rated insulation voltage	U_i	V 690	690
For use in IT electrical power networks	V	400 / 415	400 / 415
Direction of incoming supply		As required	As required
Number of electrical operating cycles		> 1.500	1.000
Tripping characteristic			
Conventional non-tripping current		$I_{nt} = 1.05 I_n$	$I_{nt} = 1.05 I_n$
Conventional tripping current		$I_t = 1.30 I_n$	$I_t = 1.30 I_n$
Reference temperature	°C	30	30

BREAKING CAPACITY

	MB1E – MB1..8 MB1B – MB1..1 MB2B – MB2C					
Breaking capacity						
Rated short-circuit breaking capacity						
I_{cu} to IEC/EN 60947 operating sequence 0-t-CO, 400/415 V 50/60 Hz	I_{cu}	kA	18	25	25	36
I_{cs} to IEC/EN 60947 operating sequence 0-t-CO-t-CO, 400/415 V 50/60 Hz	I_{cs}	kA	9	12.5	12.5	9
Utilization category to IEC/EN 60947-2		A	A	A	A	A

LET-THROUGH ENERGY MB1

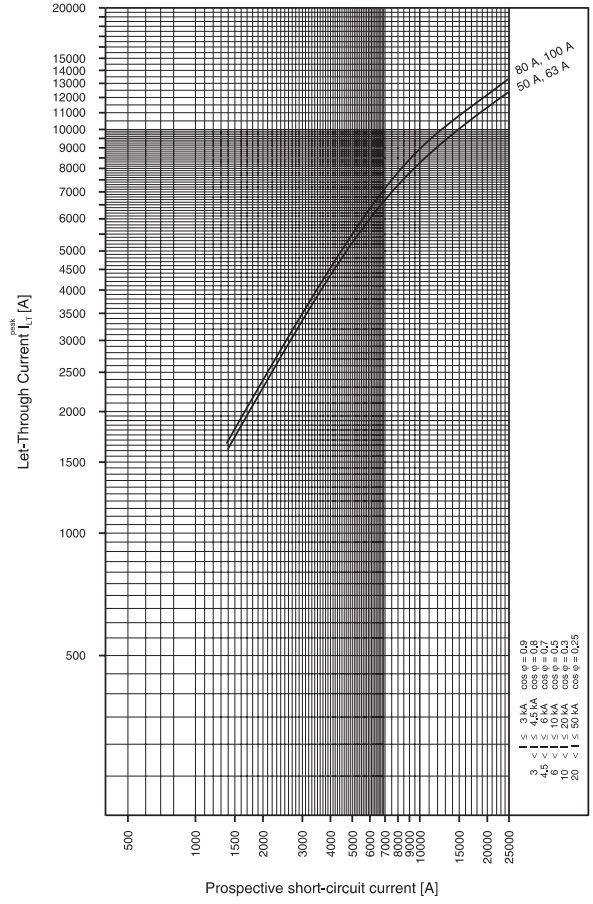
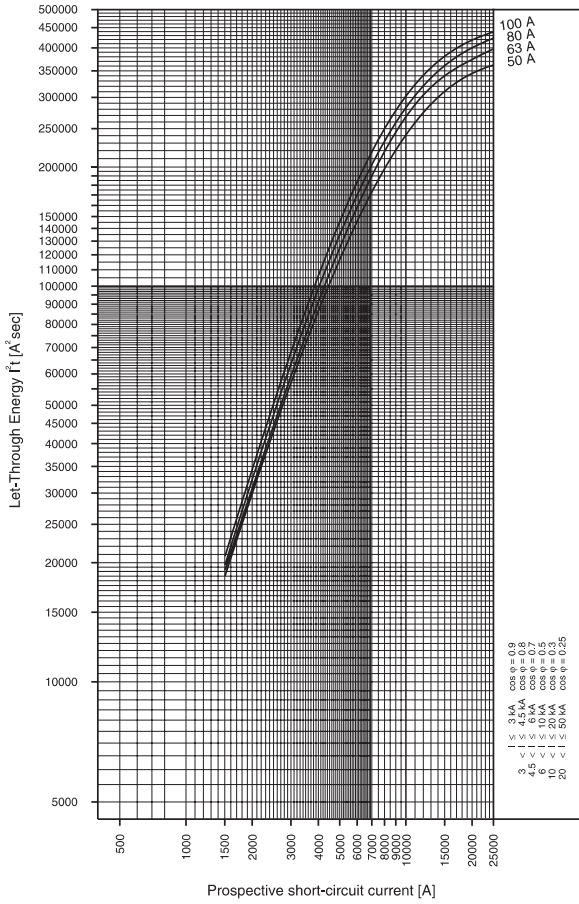

LET-THROUGH ENERGY MB2

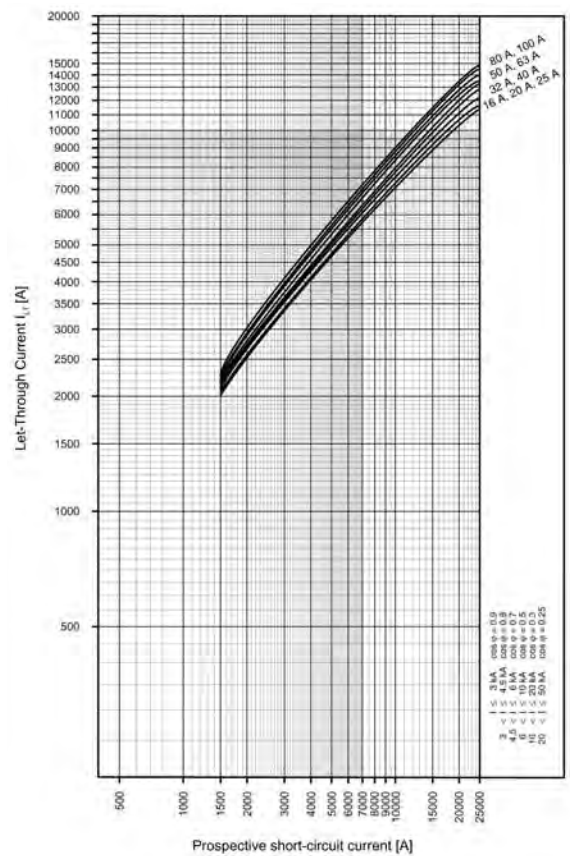
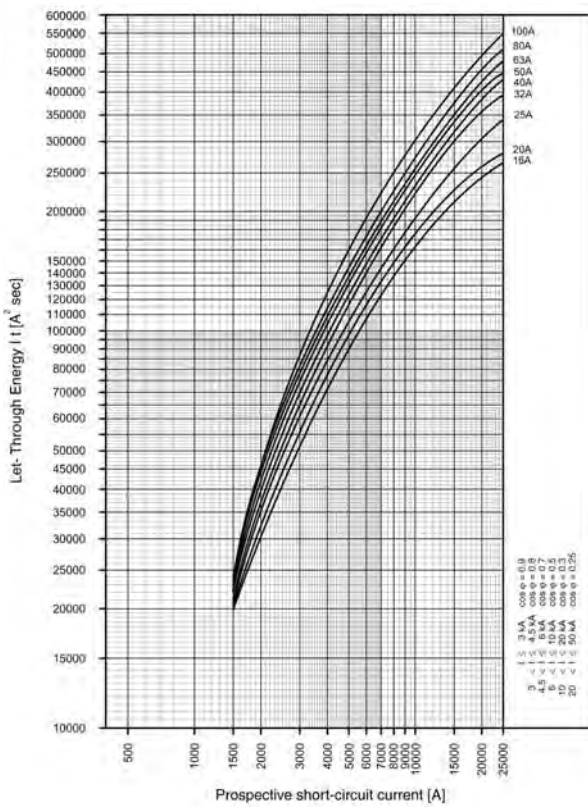

▀ MOUNTING HOLES MB1

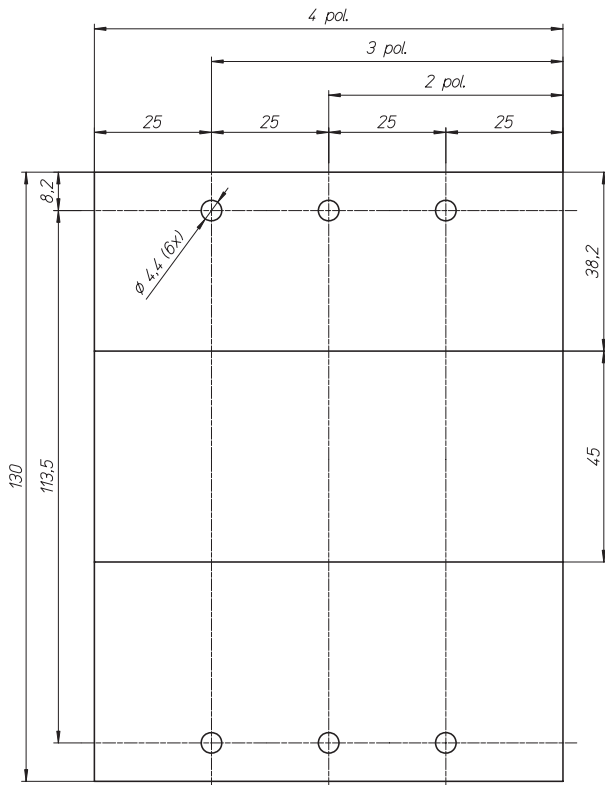

▀ MOUNTING HOLES MB2

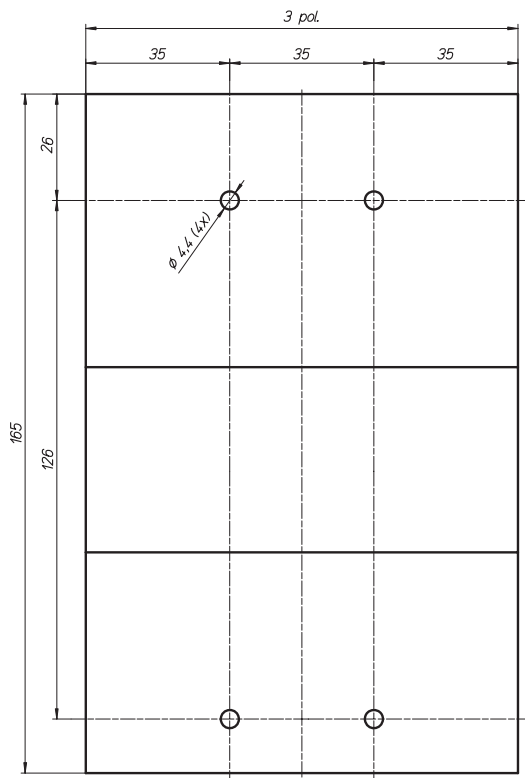

All dimensions in mm

■ CIRCUIT BREAKER MB1, 3-POLE

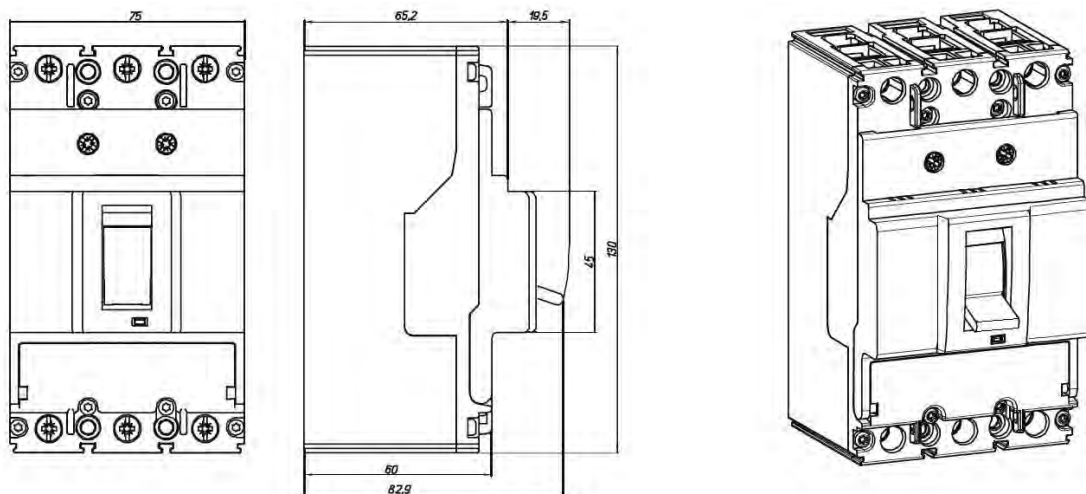

■ CIRCUIT BREAKER MB1, 4-POLE

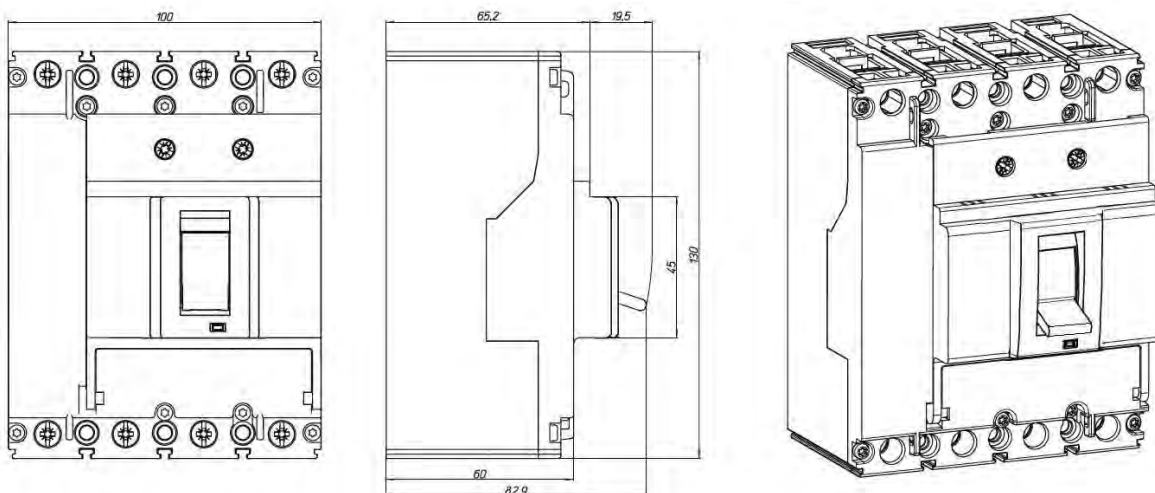

■ CIRCUIT BREAKER MB2, 3-POLE

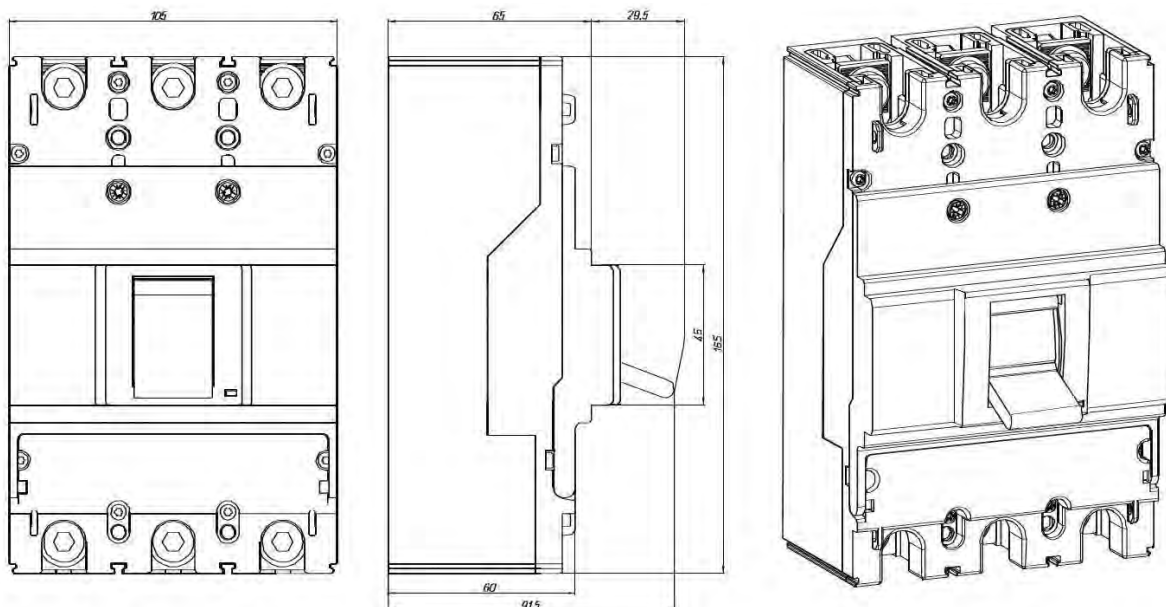

All dimensions in mm

THE COMPANY

HEADQUARTERS

SCHRACK TECHNIK GMBH
Seybelgasse 13, A-1230 Vienna
PHONE +43(0)1/866 85-5900
FAX +43(0)1/866 85-98804
E-MAIL export@schrack.com



SCHRACK COMPANIES

BELGIUM

SCHRACK TECHNIK B.V.B.A
Twaalfapostelenstraat 14
BE-9051 St-Denijs-Westrem
PHONE +32 9/384 79 92
FAX +32 9/384 87 69
E-MAIL info@schrack.be

CROATIA

SCHRACK TECHNIK D.O.O.
Zavrtnica 17
HR-10000 Zagreb
PHONE +385 1/605 55 00
FAX +385 1/605 55 66
E-MAIL schrack@schrack.hr

POLAND

SCHRACK TECHNIK
POLSKA SP.Z.O.O.
ul. Staniewicka 5
PL-03-310 Warszawa
PHONE +48 22/331 48 31
FAX +48 22/331 48 33
E-MAIL se@schrack.pl

ROMANIA

SCHRACK TECHNIK SRL
Str. Simion Barnutiu nr. 15
RO-410204 Oradea
PHONE +40 259/435 887
FAX +40 259/412 892
E-MAIL schrack@schrack.ro

SERBIA

SCHRACK TECHNIK D.O.O.
Kumodraska 260
RS-11000 Beograd
PHONE +38 1/11 309 2600
FAX +38 1/11 309 2620
E-MAIL office@schrack.co.yu

SLOVAKIA

SCHRACK TECHNIK SPOL. SR.O.
Langsfeldova 2
SK-03601 Martin
PHONE +42 1/43 422 16 41
FAX +42 1/43 423 95 56
E-MAIL martin@schrack.sk

SLOVENIA

SCHRACK TECHNIK D.O.O.
Pameče 175
SLO-2380 Slovenj Gradec
PHONE +38 6/2 883 92 00
FAX +38 6/2 884 34 71
E-MAIL schrack.sg@schrack.si

CZECH REPUBLIC

SCHRACK TECHNIK SPOL. SR.O.
Dolnomecholupska 2
CZ-10200 Praha 10 – Hostivar
PHONE +42(0)2/810 08 264
FAX +42(0)2/810 08 462
E-MAIL praha@schrack.cz

HUNGARY

SCHRACK TECHNIK KFT.
Vidor u. 5
H-1172 Budapest
PHONE +36 1/253 14 01
FAX +36 1/253 14 91
E-MAIL schrack@schrack.hu