

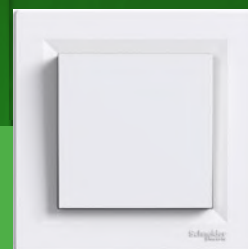

Asfora

Catalog 2019



Life Is On

Schneider
Electric



Content

4	Asfora presentation
10	Switches
12	Push-buttons
14	Socket-outlets
16	Communication outlets
18	Rotary dimmers and USB chargers
19	Accessories
20	Technical information - Switches and push-buttons
21	Technical information - Dimmers
22	Technical information - Antenna outlets
24	Technical information - Surface-mounted boxes
25	Technical information - Dimensions
26	Reference numbers

Asfora makes life easier

With its sleek and elegant designs, the Asfora range delivers everything today's wiring devices should.

Your customers will appreciate the ease-of-use and wide range of everyday functions offered by Asfora wiring devices, designed to be as pleasing to the touch as they are to the eye.



white, glossy



cream, glossy



bronze, painted



athracite, painted



aluminium, painted



steel, painted

6

colors

2

finishes

50+

functions



Up to 6 gangs

Whether it is for a home or small office, Asfora multi-gang cover frames are designed for easy handling during installation and a neat and tidy appearance, with several functions housed in a single unit.

Light and comfort

Help your customers get the most out of their home interiors with unique lighting ambiances for each room and each time of day.



Switch



Switch with locator lamp and icon



Dimmer



Roller blind switch

Connectivity

Help your customers to keep the digital world close at hand. They can access all media from a single jack or enjoy music from a single source throughout the home.



TV/R/SAT socket



RJ45 data socket



Loudspeaker socket

Protection

Socket-outlets with shutters that protect from touching the live parts are recommended for families with children. IP44 products are often required in the bathroom and kitchen to protect from water splashes.



Socket outlet with lid



IP44 socket outlet with lid

New IP44 gaskets



In wet areas or conditions, switches and socket outlets must conform to strict regulatory standards, which state that they must be splash proof.

The new IP44 gasket for switches and single socket outlets has the advantage of being more universal, even on uneven surfaces. Moreover the gasket is flexible in the area of the box screws, so the screws do not need to be removed for installation. This makes installation quick and easy.

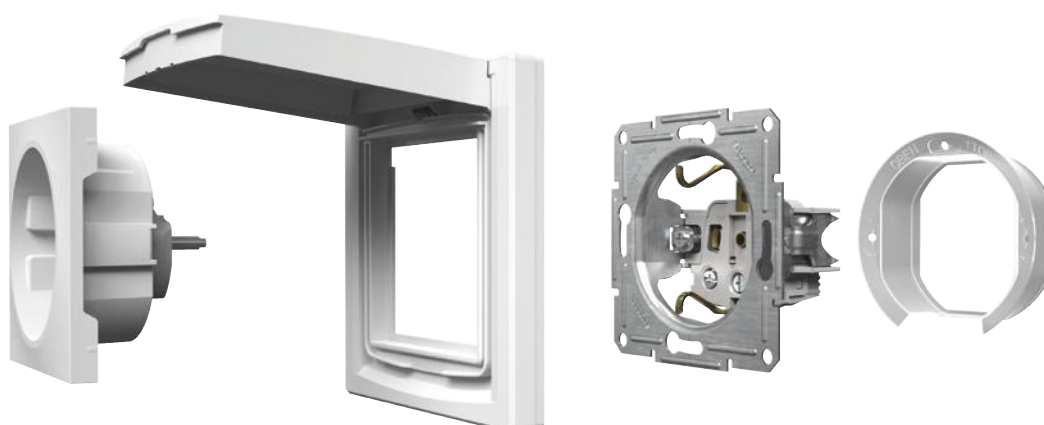

Quick and easy to install



Universal shape
Also suitable for
uneven walls

Flexible in the area of
box screws
No need to remove
screws for installation

IMPROVED!

Splash proof



Asfora IP44 gasket

The new generation of inserts for switches and single socket outlets

New inserts – new and improved features!

At Schneider Electric, we listen to your feedback and understand what you need to make your daily work routine easier and more efficient. This is why we recently improved the quality and functionality of inserts for the Asfora range. The updated Asfora range now features smaller, more compact inserts, a profiled fixing frame, improved wire inlets and release buttons, and wide, profiled claws with a return spring.

NEW!

- + easy
- + fast
- + convenient

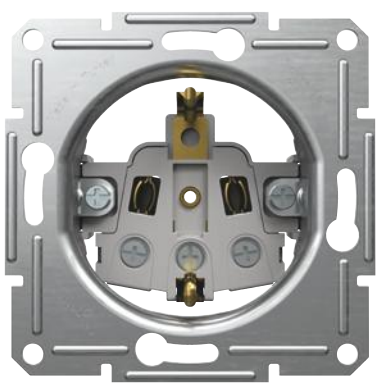

socket outlet insert

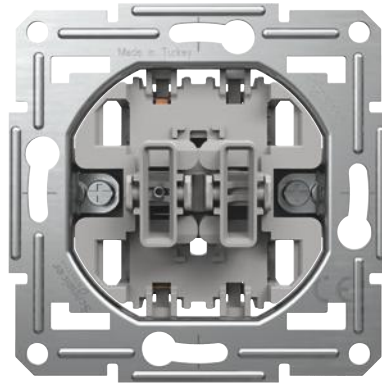

switch insert



Asfora pin earth



Asfora side earth

Smaller and more compact inserts

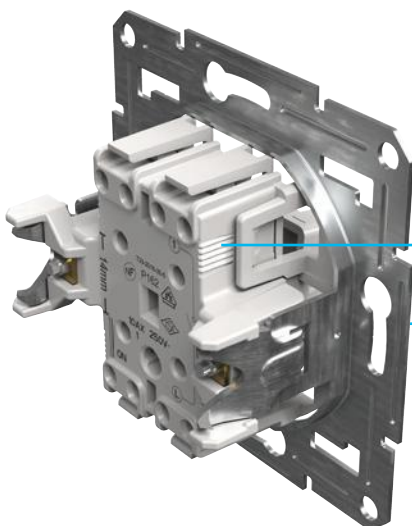

Smaller and more compact inserts

give better insert rotation on box screws, more space to manage wires in the box, and a better view inside the box

Redesigned insert shape

offers additional handling grips for better handling

Improved fixing frame and claws

For a simple, fast, and safe installation

Thanks to their redesigned mechanism the claws extend out straight and smoothly, ensuring a perfect alignment to the wall boxes during assembly. Moreover they ensure that the insert fixes securely in the box.

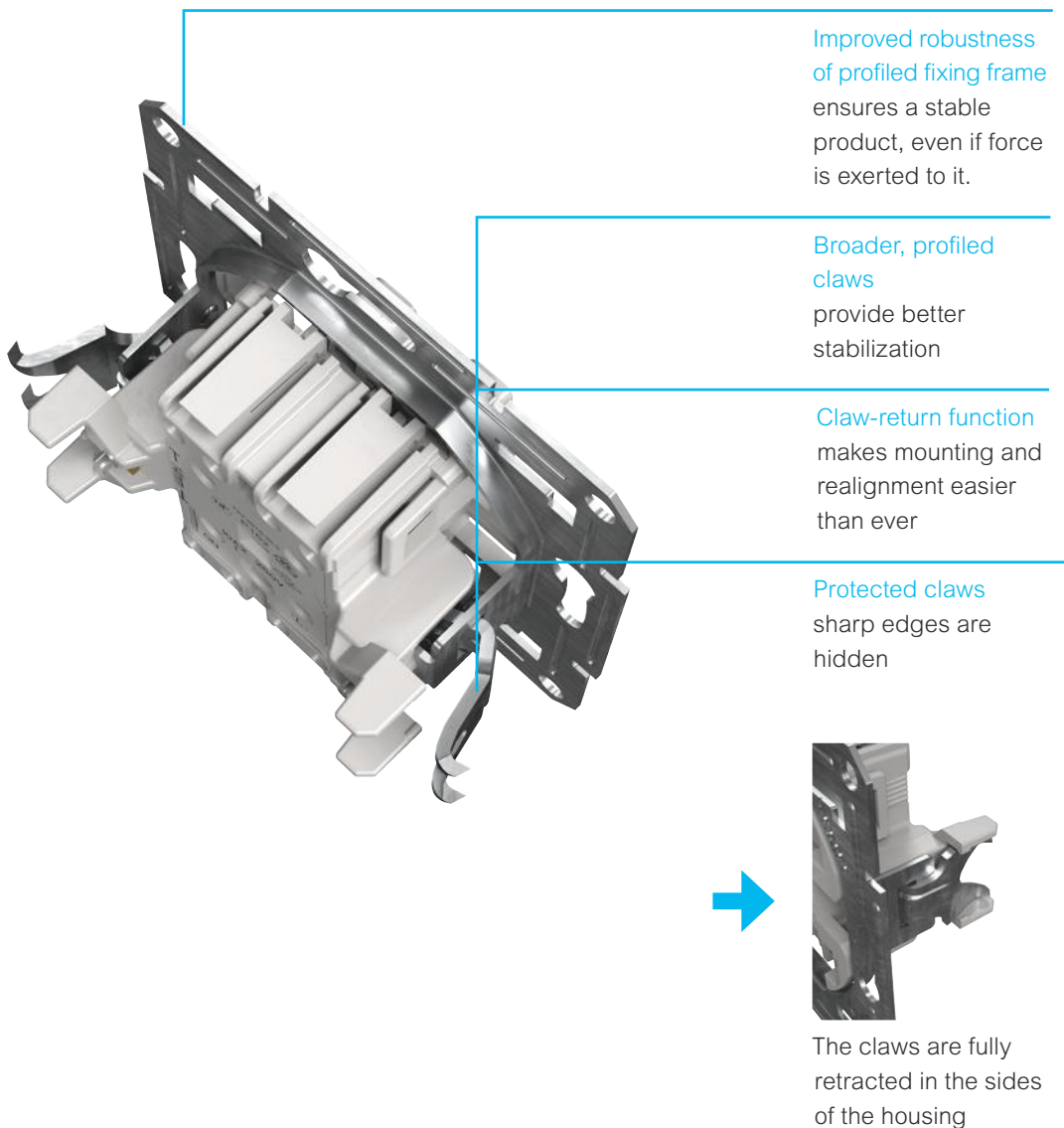

Clear connection diagram, improved wire inlets for switches, and better shaped release levers for screwless switches

Our innovative new features will make all the difference to your daily installation workflow.

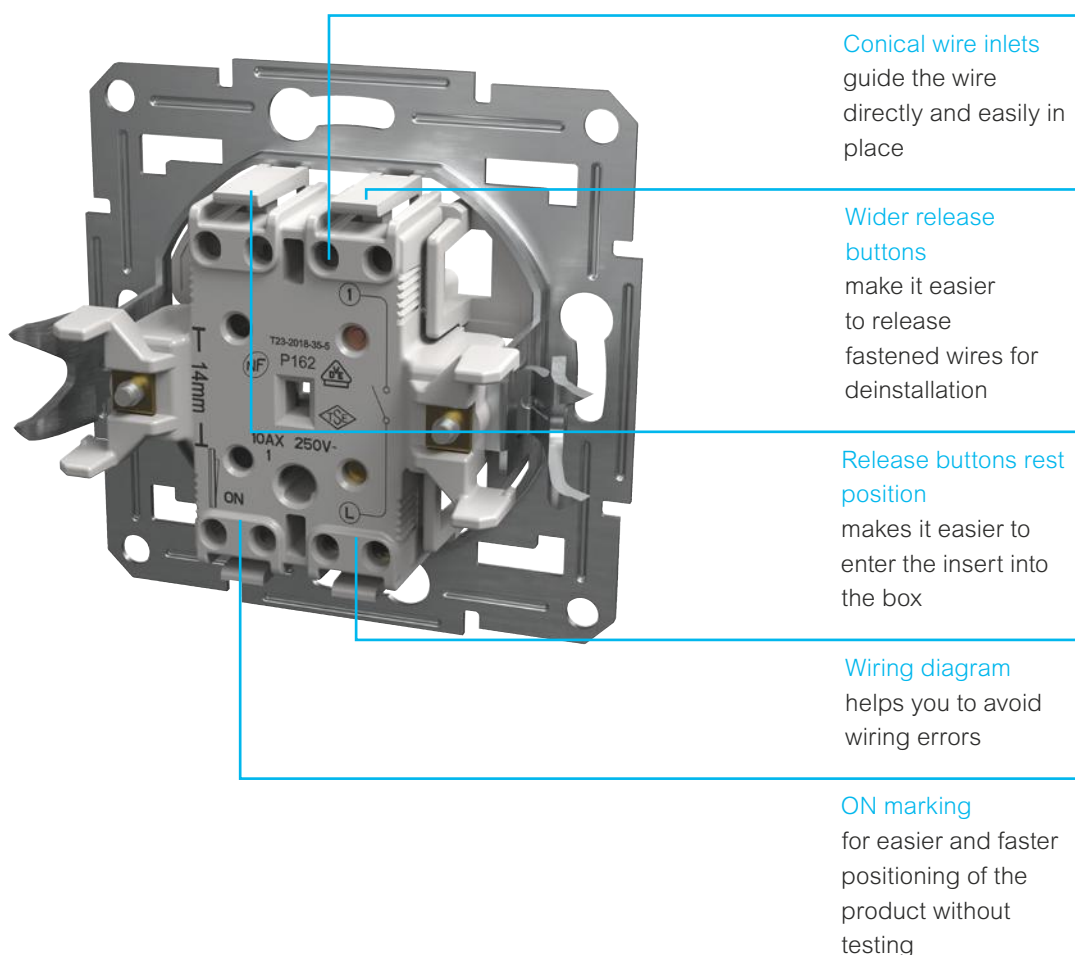

Switches - 10 AX - 250 V AC

1-way	2-way	Intermediate	2-circuit	Double 2-way	2-pole	3-circuit

Screwless terminals

--	--	--	--	--	--	--

With cover frame

<input type="checkbox"/> white	EPH0100121	EPH0400121	EPH0500121	EPH0300121	EPH0600121	EPH0200121	
<input type="checkbox"/> cream	EPH0100123	EPH0400123	EPH0500123	EPH0300123	EPH0600123	EPH0200123	

--	--	--	--	--	--	--

Without cover frame

<input type="checkbox"/> white	EPH0170121	EPH0470121	EPH0570121	EPH0370121	EPH0670121	EPH0270121	
<input type="checkbox"/> cream	EPH0170123	EPH0470123	EPH0570123	EPH0370123	EPH0670123	EPH0270123	
<input type="checkbox"/> anthracite	EPH0100171	EPH0400171	EPH0500171	EPH0300171	EPH0600171	EPH0200171	
<input type="checkbox"/> steel	EPH0100162	EPH0400162	EPH0500162	EPH0300162	EPH0600162	EPH0200162	
<input type="checkbox"/> aluminium	EPH0100161	EPH0400161	EPH0500161	EPH0300161	EPH0600161	EPH0200161	
<input type="checkbox"/> bronze	EPH0100169	EPH0400169	EPH0500169	EPH0300169	EPH0600169	EPH0200169	

Screw terminals

--	--	--	--	--	--	--

With cover frame

<input type="checkbox"/> white	EPH0100321	<u>EPH0400321</u>	EPH0500321	EPH0300321	EPH0600321	EPH0200321	EPH2100121
<input type="checkbox"/> cream	EPH0100323	<u>EPH0400323</u>	EPH0500323	EPH0300323	EPH0600323	EPH0200323	EPH2100123

--	--	--	--	--	--	--

Without cover frame

<input type="checkbox"/> white							EPH2170121
<input type="checkbox"/> cream							EPH2170123
<input type="checkbox"/> anthracite	EPH0100371	EPH0400371	EPH0500371	EPH0300371	EPH0600371	EPH0200371	EPH2100171
<input type="checkbox"/> steel	EPH0100362	EPH0400362	EPH0500362	EPH0300362	EPH0600362	EPH0200362	EPH2100162
<input type="checkbox"/> aluminium	EPH0100361	EPH0400361	EPH0500361	EPH0300361	EPH0600361	EPH0200361	EPH2100161
<input type="checkbox"/> bronze	EPH0100369	EPH0400369	EPH0500369	EPH0300369	EPH0600369	EPH0200369	EPH2100169

Switches IP44 - 10 AX - 250 V AC

1-way	2-way

Screwless terminals

--

With cover frame

<input type="checkbox"/> white	EPH0100221	EPH0400421
<input type="checkbox"/> cream	EPH0100223	EPH0400423
<input type="checkbox"/> anthracite	EPH0100271	EPH0400471
<input type="checkbox"/> steel	EPH0100262	EPH0400462
<input type="checkbox"/> aluminium	EPH0100261	EPH0400461
<input type="checkbox"/> bronze	EPH0100269	EPH0400469

Characteristics

- Maximum load for self ballasted lamps (LED, CFL, etc.):
10 AX - 250 V AC switches: 100 W
16 AX - 250 V AC switches: 200 W

Switches with locator lamp 10 AX - 250 V AC



Screwless terminals



With cover frame

<input type="checkbox"/> white	EPH1400121	EPH1500121
<input type="checkbox"/> cream	EPH1400123	EPH1500123



Without cover frame

<input type="checkbox"/> white	EPH1470121	EPH1570121
<input type="checkbox"/> cream	EPH1470123	EPH1570123
<input type="checkbox"/> anthracite	EPH1400171	EPH1500171
<input type="checkbox"/> steel	EPH1400162	EPH1500162
<input type="checkbox"/> aluminium	EPH1400161	EPH1500161
<input type="checkbox"/> bronze	EPH1400169	EPH1500169

Screw terminals



With cover frame

<input type="checkbox"/> white	EPH1400321	EPH1500321
<input type="checkbox"/> cream	EPH1400323	EPH1500323



Without cover frame

<input type="checkbox"/> anthracite	EPH1400371	EPH1500371
<input type="checkbox"/> steel	EPH1400362	EPH1500362
<input type="checkbox"/> aluminium	EPH1400361	EPH1500361
<input type="checkbox"/> bronze	EPH1400369	EPH1500369

Switches with locator lamp 16 AX - 250 V AC

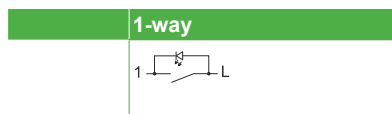

Screw terminals



With cover frame

<input type="checkbox"/> white	EPH1430321
<input type="checkbox"/> cream	EPH1430323



Without cover frame

<input type="checkbox"/> anthracite	EPH1430371
<input type="checkbox"/> steel	EPH1430362
<input type="checkbox"/> aluminium	EPH1430361
<input type="checkbox"/> bronze	EPH1430369

Roller blind switches 10 A - 250 V AC

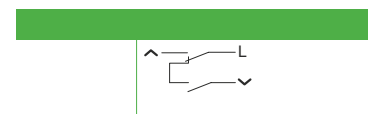

Screwless terminals



With cover frame

<input type="checkbox"/> white	EPH1300521
<input type="checkbox"/> cream	EPH1300523



Without cover frame

<input type="checkbox"/> white	EPH1370521
<input type="checkbox"/> cream	EPH1370523
<input type="checkbox"/> anthracite	EPH1300571
<input type="checkbox"/> steel	EPH1300562
<input type="checkbox"/> aluminium	EPH1300561
<input type="checkbox"/> bronze	EPH1300569

Key card switches 10 A - 250 V AC

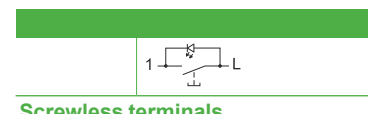

Screwless terminals



With cover frame

<input type="checkbox"/> white	EPH6200121
<input type="checkbox"/> cream	EPH6200123



Without cover frame

<input type="checkbox"/> white	EPH6270121
<input type="checkbox"/> cream	EPH6270123
<input type="checkbox"/> anthracite	EPH6200171
<input type="checkbox"/> steel	EPH6200162
<input type="checkbox"/> aluminium	EPH6200161
<input type="checkbox"/> bronze	EPH6200169

Characteristics

- Maximum load for self ballasted lamps (LED, CFL, etc.):
 - 10 AX - 250 V AC switches: 100 W
 - 16 AX - 250 V AC switches: 200 W

Push-buttons - 10 A - 250 V AC

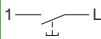
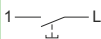
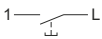
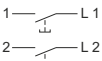
	Single 1-way	1-way with "bell" symbol	1-way with "light" symbol	Double Double 1-way
				

Screwless terminals

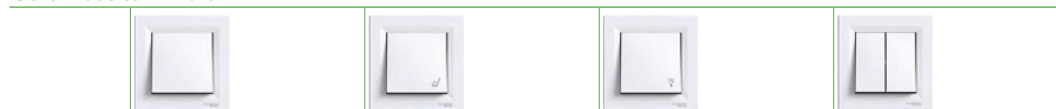

With cover frame

<input type="checkbox"/> white	EPH0700121	EPH0800121	EPH0900121	EPH1100121
<input type="checkbox"/> cream	EPH0700123	EPH0800123	EPH0900123	EPH1100123



Without cover frame

<input type="checkbox"/> white	EPH0770121	EPH0870121	EPH0970121	EPH1170121
<input type="checkbox"/> cream	EPH0770123	EPH0870123	EPH0970123	EPH1170123
<input type="checkbox"/> anthracite	EPH0700171	EPH0800171	EPH0900171	EPH1100171
<input type="checkbox"/> steel	EPH0700162	EPH0800162	EPH0900162	EPH1100162
<input type="checkbox"/> aluminium	EPH0700161	EPH0800161	EPH0900161	EPH1100161
<input type="checkbox"/> bronze	EPH0700169	EPH0800169	EPH0900169	EPH1100169

Screw terminals

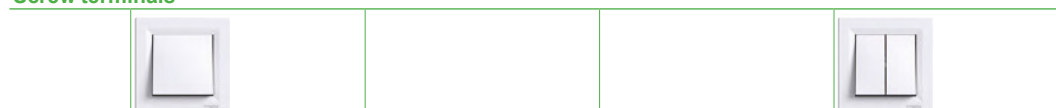

With cover frame

<input type="checkbox"/> white	EPH0800321			EPH1100321
<input type="checkbox"/> cream	EPH0800323			EPH1100323



Without cover frame

<input type="checkbox"/> anthracite	EPH0800371			EPH1100371
<input type="checkbox"/> steel	EPH0800362			EPH1100362
<input type="checkbox"/> aluminium	EPH0800361			EPH1100361
<input type="checkbox"/> bronze	EPH0800369			EPH1100369

Push-buttons with locator lamp 10 A - 250 V AC

1-way	1-way with "bell" symbol	1-way with "light" symbol	1-way with "stairs" symbol

Screwless terminals



With cover frame

<input type="checkbox"/> white	EPH1600121	EPH1700121	EPH1800121	EPH1900121
<input type="checkbox"/> cream	EPH1600123	EPH1700123	EPH1800123	EPH1900123



Without cover frame

<input type="checkbox"/> white	EPH1670121	EPH1770121	EPH1870121	
<input type="checkbox"/> cream	EPH1670123	EPH1770123	EPH1870123	
<input type="checkbox"/> anthracite	EPH1600171	EPH1700171	EPH1800171	EPH1900171
<input type="checkbox"/> steel	EPH1600162	EPH1700162	EPH1800162	EPH1900162
<input type="checkbox"/> aluminium	EPH1600161	EPH1700161	EPH1800161	EPH1900161
<input type="checkbox"/> bronze	EPH1600169	EPH1700169	EPH1800169	EPH1900169

Screw terminals



With cover frame

<input type="checkbox"/> white	EPH1600321	EPH1700321		EPH1900321
<input type="checkbox"/> cream	EPH1600323	EPH1700323		EPH1900323



Without cover frame

<input type="checkbox"/> anthracite	EPH1600371	EPH1700371		EPH1900371
<input type="checkbox"/> steel	EPH1600362	EPH1700362		EPH1900362
<input type="checkbox"/> aluminium	EPH1600361	EPH1700361		EPH1900361
<input type="checkbox"/> bronze	EPH1600369	EPH1700369		EPH1900369

Roller blind push-buttons 10 A - 250 V AC

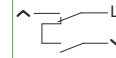

Screwless terminals



With cover frame

<input type="checkbox"/> white	EPH1300121
<input type="checkbox"/> cream	EPH1300123



Without cover frame

<input type="checkbox"/> white	EPH1370121
<input type="checkbox"/> cream	EPH1370123
<input type="checkbox"/> anthracite	EPH1300171
<input type="checkbox"/> steel	EPH1300162
<input type="checkbox"/> aluminium	EPH1300161
<input type="checkbox"/> bronze	EPH1300169

Screw terminals

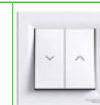

With cover frame

<input type="checkbox"/> white	EPH1300321
<input type="checkbox"/> cream	EPH1300323



Without cover frame

<input type="checkbox"/> anthracite	EPH1300371
<input type="checkbox"/> steel	EPH1300362
<input type="checkbox"/> aluminium	EPH1300361
<input type="checkbox"/> bronze	EPH1300369

Push-buttons - 12 V AC with locator lamp and label holder

1-way

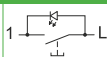





Screwless terminals



With cover frame

<input type="checkbox"/> white	EPH1601521
<input type="checkbox"/> cream	EPH1601523

Socket-outlets - 2P - 16 A - 250 V AC

	Single	Double ^[*]	Double PL standard ^[*]
Screw terminals			
			
With cover frame			
<input type="checkbox"/> white	EPH3000121	EPH9700121 ^[*]	EPH9700221 ^[*]
<input type="checkbox"/> cream	EPH3000123	EPH9700123 ^[*]	EPH9700223 ^[*]
<input type="checkbox"/> anthracite		EPH9700171 ^[*]	EPH9700271 ^[*]
<input type="checkbox"/> steel		EPH9700162 ^[*]	EPH9700262 ^[*]
<input type="checkbox"/> aluminium		EPH9700161 ^[*]	EPH9700261 ^[*]
<input type="checkbox"/> bronze		EPH9700169 ^[*]	EPH9700269 ^[*]
			
Without cover frame			
<input type="checkbox"/> anthracite	EPH3000171		
<input type="checkbox"/> steel	EPH3000162		
<input type="checkbox"/> aluminium	EPH3000161		
<input type="checkbox"/> bronze	EPH3000169		









[*] Not compatible with frame system.

Socket-outlets - 2P+E (pin earth) - 16 A - 250 V AC

	Single	Single with shutters	Single with shutters and lid IP44	Single with shutters and lid IP44 ^[*]	Single with red center plate	Double CZ, SK standards ^[*]	Double PL standard ^[*]
Screw terminals							
							
With cover frame							
<input type="checkbox"/> white	EPH2800121	EPH2800221	EPH2800621	EPH2800321 ^[*]	EPH2800421	EPH9800121 ^[*]	EPH9800221 ^[*]
<input type="checkbox"/> cream	EPH2800123	EPH2800223	EPH2800623	EPH2800323 ^[*]	EPH2800423	EPH9800123 ^[*]	EPH9800223 ^[*]
<input type="checkbox"/> anthracite				EPH2800371 ^[*]		EPH9800171 ^[*]	EPH9800271 ^[*]
<input type="checkbox"/> steel				EPH2800362 ^[*]		EPH9800162 ^[*]	EPH9800262 ^[*]
<input type="checkbox"/> aluminium				EPH2800361 ^[*]		EPH9800161 ^[*]	EPH9800261 ^[*]
<input type="checkbox"/> bronze				EPH2800369 ^[*]		EPH9800169 ^[*]	EPH9800269 ^[*]
							
Without cover frame							
<input type="checkbox"/> white	EPH2870121						EPH9810221
<input type="checkbox"/> cream	EPH2870123						EPH9810223
<input type="checkbox"/> anthracite	EPH2800171	EPH2800271	EPH2800671				EPH9810271
<input type="checkbox"/> steel	EPH2800162	EPH2800262	EPH2800662				EPH9810262
<input type="checkbox"/> aluminium	EPH2800161	EPH2800261	EPH2800661				EPH9810261
<input type="checkbox"/> bronze	EPH2800169	EPH2800269	EPH2800669				EPH9810269
<input type="checkbox"/> red	EPH2870442						

[*] Not compatible with frame system.

Socket-outlets - 2P+E (side earth) - 16 A - 250 V AC

	Single	Single with shutters	Single with lid	Single with shutters and lid IP44 ^[*]	Single with shutters and red center plate	Double ^[*]
Screw terminals						
						
With cover frame						
<input type="checkbox"/> white	EPH2900121	EPH2900221	EPH3100121	EPH3100321 ^[*]	EPH2900521	EPH9900121 ^[*]
<input type="checkbox"/> cream	EPH2900123	EPH2900223	EPH3100123	EPH3100323 ^[*]	EPH2900523	EPH9900123 ^[*]
<input type="checkbox"/> anthracite				EPH3100371 ^[*]		EPH9900171 ^[*]
<input type="checkbox"/> steel				EPH3100362 ^[*]		EPH9900162 ^[*]
<input type="checkbox"/> aluminium				EPH3100361 ^[*]		EPH9900161 ^[*]
<input type="checkbox"/> bronze				EPH3100369 ^[*]		EPH9900169 ^[*]
						
Without cover frame						
<input type="checkbox"/> white	EPH2970121	EPH2970221	EPH3170121			
<input type="checkbox"/> cream	EPH2970123	EPH2970223	EPH3170123			
<input type="checkbox"/> anthracite	EPH2900171	EPH2900271	EPH3100171			
<input type="checkbox"/> steel	EPH2900162	EPH2900262	EPH3100162			
<input type="checkbox"/> aluminium	EPH2900161	EPH2900261	EPH3100161			
<input type="checkbox"/> bronze	EPH2900169	EPH2900269	EPH3100169			
<input type="checkbox"/> red		EPH2970542				

[*] Not compatible with frame system.

Cable outlets

Screw terminals



With cover frame

<input type="checkbox"/> white	EPH5500121
<input type="checkbox"/> cream	EPH5500123











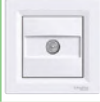

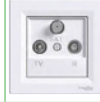

Without cover frame







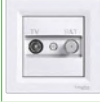



<input type="checkbox"/> white	
<input type="checkbox"/> cream	
<input type="checkbox"/> anthracite	EPH5500171
<input type="checkbox"/> steel	EPH5500162
<input type="checkbox"/> aluminium	EPH5500161
<input type="checkbox"/> bronze	EPH5500169



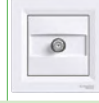





Communication outlets

Antenna outlets

Ending (1 dB)						
	TV	TV-R	TV-SAT	TV-R-SAT	TV-SAT-SAT	SAT
Type of connector	IEC Male	IEC Male + Female	IEC Male + F	IEC Male + Female + F	IEC Male + F + F	F
						
With cover frame						
<input type="checkbox"/> white	EPH3200121	EPH3300121	EPH3400121	EPH3500121	EPH3600121	EPH3700121
<input type="checkbox"/> cream	EPH3200123	EPH3300123	EPH3400123	EPH3500123	EPH3600123	EPH3700123
						
Without cover frame						
<input type="checkbox"/> white	EPH3270121	EPH3300721	EPH3470121		EPH3670121	EPH3770121
<input type="checkbox"/> cream	EPH3270123	EPH3300723	EPH3470123		EPH3670123	EPH3770123
<input type="checkbox"/> anthracite	EPH3200171	EPH3300171	EPH3400171	EPH3500171	EPH3600171	EPH3700171
<input type="checkbox"/> steel	EPH3200162	EPH3300162	EPH3400162	EPH3500162	EPH3600162	EPH3700162
<input type="checkbox"/> aluminium	EPH3200161	EPH3300161	EPH3400161	EPH3500161	EPH3600161	EPH3700161
<input type="checkbox"/> bronze	EPH3200169	EPH3300169	EPH3400169	EPH3500169	EPH3600169	EPH3700169



Individual (1 dB)	
Type of connector	TV-SAT
	
With cover frame	
<input type="checkbox"/> white	EPH3400421
<input type="checkbox"/> cream	EPH3400423
	
Without cover frame	
<input type="checkbox"/> anthracite	EPH3400471
<input type="checkbox"/> steel	EPH3400462
<input type="checkbox"/> aluminium	EPH3400461
<input type="checkbox"/> bronze	EPH3400469

Intermediate (4 dB)						
	TV	TV-R	TV-SAT	TV-R-SAT		SAT
						
With cover frame						
<input type="checkbox"/> white	EPH3200221	EPH3300221	EPH3400221	EPH3500221		EPH3700221
<input type="checkbox"/> cream	EPH3200223	EPH3300223	EPH3400223	EPH3500223		EPH3700223
						
Without cover frame						
<input type="checkbox"/> anthracite	EPH3200271	EPH3300271	EPH3400271	EPH3500271		EPH3700271
<input type="checkbox"/> steel	EPH3200262	EPH3300262	EPH3400262	EPH3500262		EPH3700262
<input type="checkbox"/> aluminium	EPH3200261	EPH3300261	EPH3400261	EPH3500261		EPH3700261
<input type="checkbox"/> bronze	EPH3200269	EPH3300269	EPH3400269	EPH3500269		EPH3700269

Intermediate (8 dB)				
	TV	TV-R	TV-SAT	TV-R-SAT
				
With cover frame				
<input type="checkbox"/> white	EPH3200321	EPH3300321	EPH3400321	EPH3500321
<input type="checkbox"/> cream	EPH3200323	EPH3300323	EPH3400323	EPH3500323
				
Without cover frame				
<input type="checkbox"/> white	EPH3270321		EPH3470321	
<input type="checkbox"/> cream	EPH3270323		EPH3470323	
<input type="checkbox"/> anthracite	EPH3200371	EPH3300371	EPH3400371	EPH3500371
<input type="checkbox"/> steel	EPH3200362	EPH3300362	EPH3400362	EPH3500362
<input type="checkbox"/> aluminium	EPH3200361	EPH3300361	EPH3400361	EPH3500361
<input type="checkbox"/> bronze	EPH3200369	EPH3300369	EPH3400369	EPH3500369

Communication outlets

Data and telephone outlets

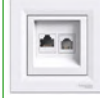
	Single RJ11	RJ45 Cat.5e UTP	RJ45 Cat.5e STP	RJ45 Cat.6 UTP		
Terminals	Screw	IDC	IDC	IDC		
						
With cover frame						
<input type="checkbox"/> white	EPH4100121	EPH4300121	EPH5000121	EPH4700121		
<input type="checkbox"/> cream	EPH4100123	EPH4300123	EPH5000123	EPH4700123		
						
Without cover frame						
<input type="checkbox"/> white	EPH4170121	EPH4370121		EPH4770121		
<input type="checkbox"/> cream	EPH4170123	EPH4370123		EPH4770123		
<input type="checkbox"/> anthracite	EPH4100171	EPH4300171	EPH5000171	EPH4700171		
<input type="checkbox"/> steel	EPH4100162	EPH4300162	EPH5000162	EPH4700162		
<input type="checkbox"/> aluminium	EPH4100161	EPH4300161	EPH5000161	EPH4700161		
<input type="checkbox"/> bronze	EPH4100169	EPH4300169	EPH5000169	EPH4700169		
	Double RJ11	RJ45 Cat.5e UTP		RJ45 Cat.6 UTP	RJ45 + RJ11 Cat.6 UTP	RJ45 + RJ12 Cat.5e UTP
Terminals	Screw	IDC		IDC	IDC - Screw	IDC
						
With cover frame						
<input type="checkbox"/> white	EPH4200121	EPH4400121		EPH4800121	EPH5200121	EPH4900121
<input type="checkbox"/> cream	EPH4200123	EPH4400123		EPH4800123	EPH5200123	EPH4900123
						
Without cover frame						
<input type="checkbox"/> white	EPH4270121	EPH4470121		EPH4870121	EPH5270121	
<input type="checkbox"/> cream	EPH4270123	EPH4470123		EPH4870123	EPH5270123	
<input type="checkbox"/> anthracite	EPH4200171	EPH4400171		EPH4800171	EPH5200171	EPH4900171
<input type="checkbox"/> steel	EPH4200162	EPH4400162		EPH4800162	EPH5200162	EPH4900162
<input type="checkbox"/> aluminium	EPH4200161	EPH4400161		EPH4800161	EPH5200161	EPH4900161
<input type="checkbox"/> bronze	EPH4200169	EPH4400169		EPH4800169	EPH5200169	EPH4900169

Loudspeaker outlets

Double loudspeaker outlets

Screwless terminals



With cover frame

<input type="checkbox"/> white	EPH5700121
<input type="checkbox"/> cream	EPH5700123



Without cover frame

<input type="checkbox"/> white	EPH5770121
<input type="checkbox"/> cream	EPH5770123
<input type="checkbox"/> anthracite	EPH5700171
<input type="checkbox"/> steel	EPH5700162
<input type="checkbox"/> aluminium	EPH5700161
<input type="checkbox"/> bronze	EPH5700169

Rotary dimmers and USB chargers

Rotary dimmers - 230 V AC







	600 VA, 2-way	600 VA, 2-way with locator lamp ⁽¹⁾	315 VA, 2-way
	Screw terminals (pillar type)		
	With cover frame		
<input type="checkbox"/> white	EPH6400121	EPH6500121	EPH6600121
<input type="checkbox"/> cream	EPH6400123	EPH6500123	EPH6600123
	Without cover frame		
<input type="checkbox"/> white	EPH6470121	EPH6570121	EPH6670121
<input type="checkbox"/> cream	EPH6470123	EPH6570123	EPH6670123
<input type="checkbox"/> anthracite	EPH6400171	EPH6500171	EPH6600171
<input type="checkbox"/> steel	EPH6400162	EPH6500162	EPH6600162
<input type="checkbox"/> aluminium	EPH6400161	EPH6500161	EPH6600161
<input type="checkbox"/> bronze	EPH6400169	EPH6500169	EPH6600169
Others characteristics			
Short-circuit protection	Fuse F6, 3 AH - 250 V		Electronic
Loads			
230 V AC incandescent lamps	40-600 W	40-600 W	20-315 W
230 V AC halogen lamps	40-600 W	40-600 W	20-315 W
LV halogen lamps with ferromagnetic transformer	40-600 VA	40-600 VA	-
LV halogen lamps with electronic transformer	-	-	20-315 VA



(1) Locator lamp is under the rotary control button.

USB chargers



	Double USB charger type A, 2.1 A or 2 x 1.05 A	Double USB charger type A + C, 2.4 A or 2 x 1.2 A
<input type="checkbox"/> white	EPH2700221	EPH2700321
<input type="checkbox"/> cream	EPH2700223	EPH2700323
<input type="checkbox"/> anthracite	EPH2700271	EPH2700371
<input type="checkbox"/> steel	EPH2700262	EPH2700362
<input type="checkbox"/> aluminium	EPH2700261	EPH2700361
<input type="checkbox"/> bronze	EPH2700269	EPH2700369

Cover frames

	1 gang	2 gang	3 gang	4 gang	5 gang	6 gang
Horizontal						
						
						
						
<input type="checkbox"/> white	EPH5800121	EPH5800221	EPH5800321	EPH5800421	EPH5800521	EPH5800621
<input type="checkbox"/> cream	EPH5800123	EPH5800223	EPH5800323	EPH5800423	EPH5800523	EPH5800623
<input type="checkbox"/> anthracite	EPH5800171	EPH5800271	EPH5800371	EPH5800471	EPH5800571	EPH5800671
<input type="checkbox"/> steel	EPH5800162	EPH5800262	EPH5800362	EPH5800462	EPH5800562	EPH5800662
<input type="checkbox"/> aluminium	EPH5800161	EPH5800261	EPH5800361	EPH5800461	EPH5800561	EPH5800661
<input type="checkbox"/> bronze	EPH5800169	EPH5800269	EPH5800369	EPH5800469	EPH5800569	EPH5800669

	2 gang	3 gang
		
<input type="checkbox"/> white	EPH5810221	EPH5810321
<input type="checkbox"/> cream	EPH5810223	EPH5810323
<input type="checkbox"/> anthracite	EPH5810271	EPH5810371
<input type="checkbox"/> steel	EPH5810262	EPH5810362
<input type="checkbox"/> aluminium	EPH5810261	EPH5810361
<input type="checkbox"/> bronze	EPH5810269	EPH5810369

Surface-mounted boxes

	1 gang	Extension multi-gang
Screwless and screw terminals		
		
<input type="checkbox"/> white	EPH6100121	EPH6100221
<input type="checkbox"/> cream	EPH6100123	EPH6100223
<input type="checkbox"/> anthracite	EPH6100171	EPH6100271
<input type="checkbox"/> steel	EPH6100162	EPH6100262
<input type="checkbox"/> aluminium	EPH6100161	EPH6100261
<input type="checkbox"/> bronze	EPH6100169	EPH6100269

Blind covers

	
With cover frame	
<input type="checkbox"/> white	EPH5600121
<input type="checkbox"/> cream	EPH5600123
	
Without cover frame	
<input type="checkbox"/> white	EPH5670121
<input type="checkbox"/> cream	EPH5670123
<input type="checkbox"/> anthracite	EPH5600171
<input type="checkbox"/> steel	EPH5600162
<input type="checkbox"/> aluminium	EPH5600161
<input type="checkbox"/> bronze	EPH5600169

Technical information

Switches and push-buttons

Connection examples

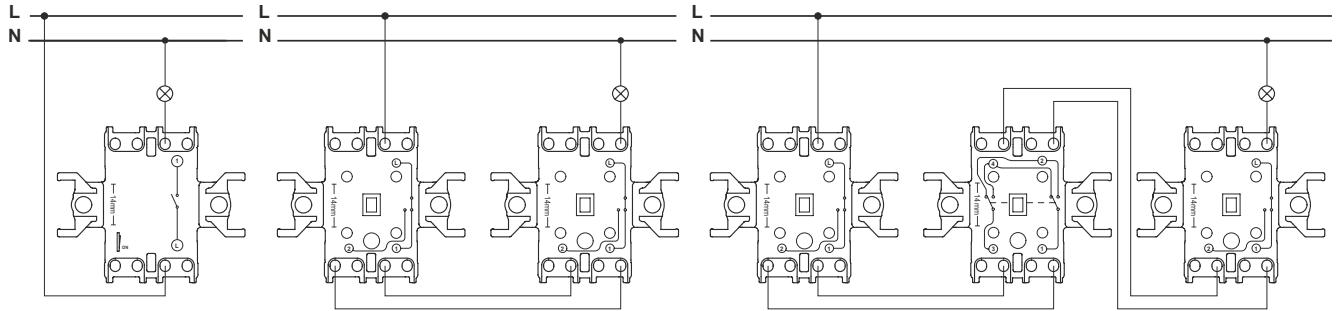

1-way switch

Two 2-way switches

Two 2-way switches + 1 intermediate switch

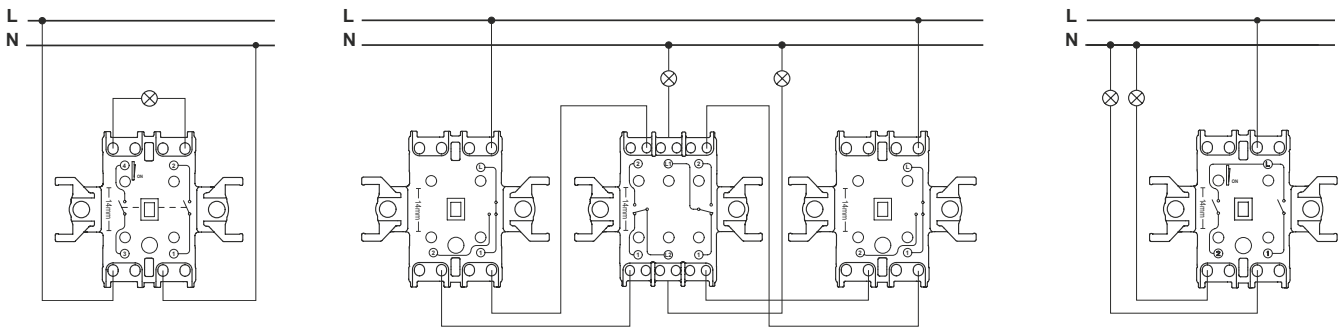

2-pole switch

Two 2-way switches + one double 2-way switch acting on two different loads

2-circuit switch

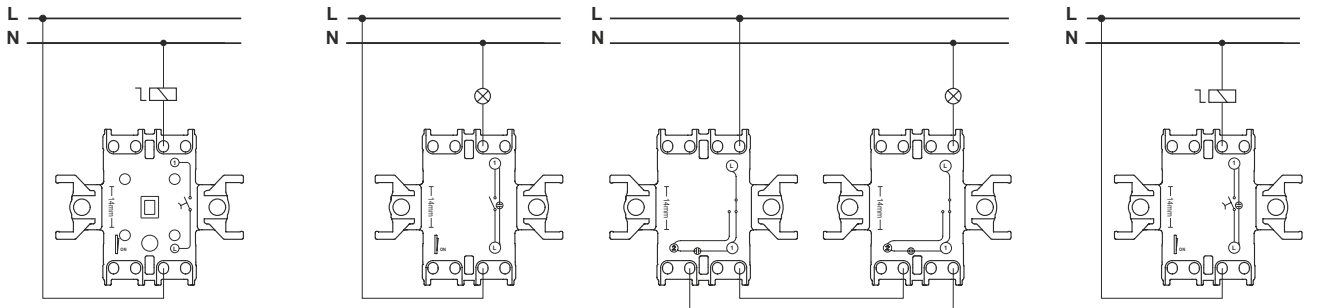

Push-button

1-way switch with locator lamp

Two 2-way switches with locator lamps

Push-button with locator lamp

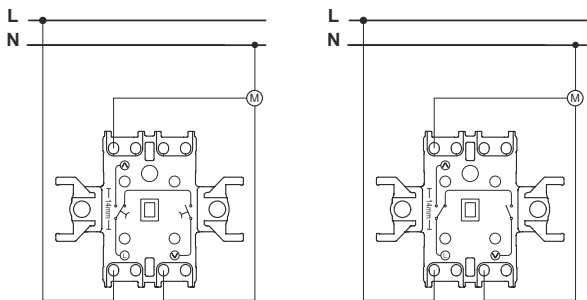

Roller blind push-button

Roller blind switch

Technical information

Dimmers

Rotary electronic dimmer

Installation

You must reduce the maximum allowed load due to the decreased heat dissipation when the device is not mounted into a single standard flushmounted mounting box.

Load reduction by	Mounted in cavity walls ⁽¹⁾	Several installed together in combination ⁽¹⁾	In 1-gang or 2-gang surface-mounted housing	In 3-gang surface-mounted housing
25 %	■	■		
30 %			■	
50 %				■

(1) If several factors apply, add the load reductions together.

Connections

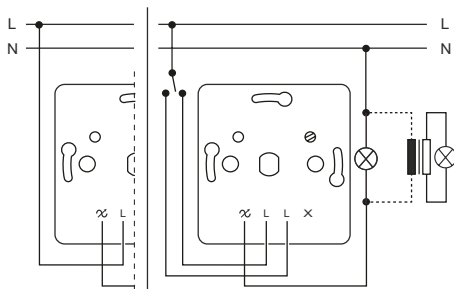

2-way switches – EPH64001xx - EPH65001xx

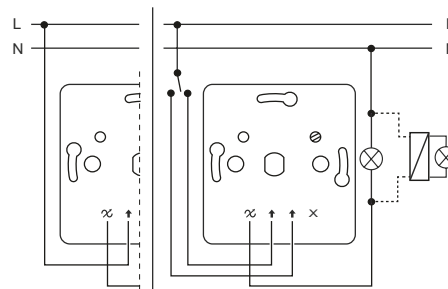

2-way switch – EPH66001xx

Substitution examples

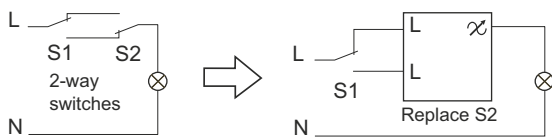
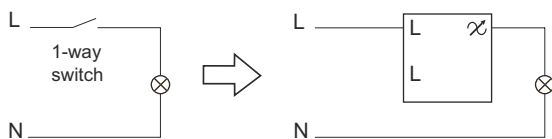

Technical information

Antenna outlets

Type		TV			TV-R		
		Ending 1 dB	Intermediate 4 dB	Intermediate 8 dB	Ending 1 dB	Intermediate 4 dB	Intermediate 8 dB
		EPH32001xx EPH32701xx	EPH32002xx	EPH32003xx EPH32703xx	EPH33001xx EPH33007xx	EPH33002xx	EPH33003xx
Loss	dB	1	4	8	1	4	8
Operating Frequency	SAT	MHz	-	-	-	-	-
	TV/VHF		5-862	5-862	5-862	118-470	118-470
	TV/UHF		5-862	5-862	5-862	470-830	470-830
	R		-	-	-	10-108	10-108
Pass through attenuation	SAT	dB	-	-	-	-	-
	TV/VHF		1	4	8	1.5	3.7
	TV/UHF		1	4	8	2.8	4.6
	R		-	-	-	11.1	9.3
Outlet attenuation	dB	1	4	8	0.5	0.5	0.5
DC Current		-	-	-	-	-	-
Outlets/line		-	-	-	1	4	4

Type		TV-SAT				TV-R-SAT		
		Ending 1 db	Intermediate 4 dB	Intermediate 8 dB	Individual 1 dB	Ending 1 db	Intermediate 4 dB	Intermediate 8 dB
		EPH34001xx EPH34701xx	EPH34002xx	EPH34003xx EPH34703xx	EPH34004xx	EPH35001xx	EPH35002xx	EPH35003xx
Loss	dB	1	4	8	1	1	4	8
Operating Frequency	SAT	MHz	950-2400	950-2400	950-2400	950-2400	950-2400	950-2400
	TV/VHF		118-470	118-470	118-470	118-470	118-470	118-470
	TV/UHF		470-830	470-830	470-830	470-830	470-830	470-830
	R		-	-	-	-	10-108	10-108
Pass through attenuation	SAT	dB	13	12.1	10.3	13	4.1	4.2
	TV/VHF		2.2	4.5	10.8	2.2	1.5	4.9
	TV/UHF		1	4.8	12.3	1	2.7	5.1
	R		-	-	-	-	14.8	16.8
Outlet attenuation	dB	-	0.5	0.5	-	-	0.5	0.5
DC Current		in SAT outlet	in SAT outlet	in SAT outlet	in SAT outlet	in SAT outlet	in SAT outlet	in SAT outlet
Outlets/line		1	4	4	1	1	4	4

Type		TV-SAT-SAT	SAT	
		Ending 1 dB	Ending 1 db	Intermediate 4 dB
		EPH36001xx EPH36701xx	EPH37001xx EPH37701xx	EPH37002xx
Loss	dB	1	1	4
Operating Frequency	SAT	MHz	950-2400	950-2400
	TV/VHF		118-470	118-470
	TV/UHF		470-830	470-830
	R		-	10-108
Pass through attenuation	SAT	dB	13	4.1
	TV/VHF		2.2	1.5
	TV/UHF		1	2.7
	R		-	14.8
Outlet attenuation	dB	-	-	0.5
DC Current		in SAT outlet	in SAT outlet	in SAT outlet
Outlets/line		1	1	4

Only one of the outlets in "Ending TV / R outlet" can also be used as individual one.

Only the cable connected outlet in "Individual TV / SAT outlet" can be used as ending one in linear installation.

Technical information

Antenna outlets

TV/R applications

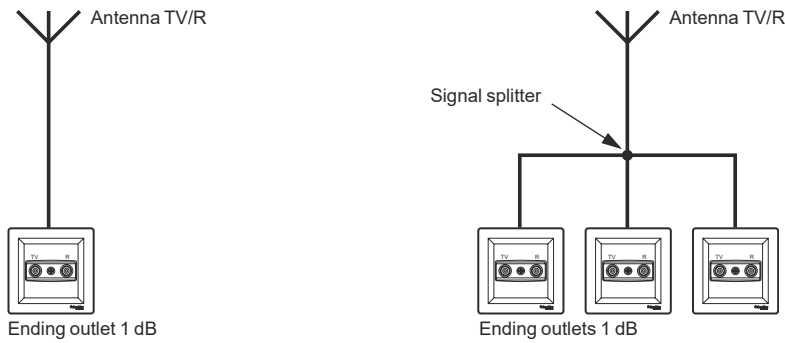

Linear installation inserts intermediate 4 dB, 8 dB and end of line 1 dB (always in the end)

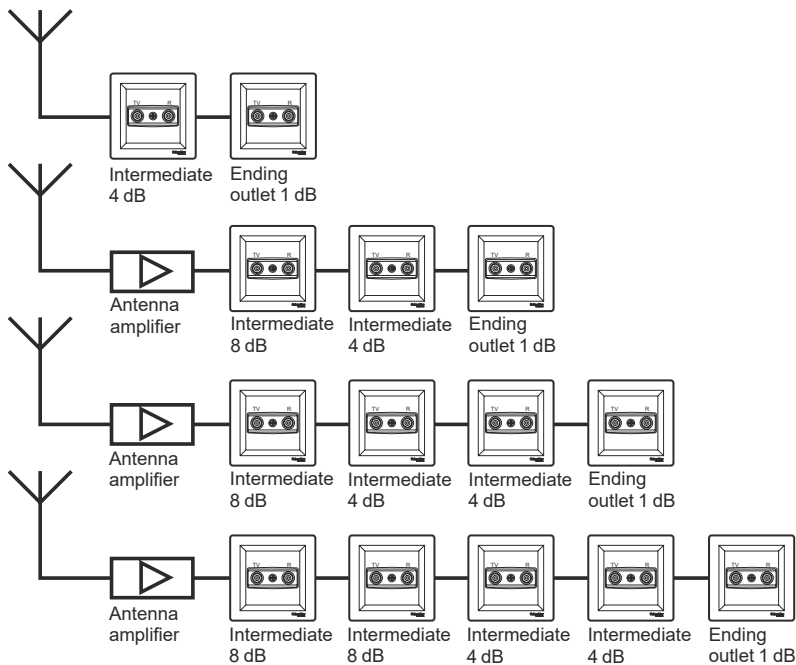

Technical information

Surface-mounted boxes

1 gang mounting

(EPH61001xx)

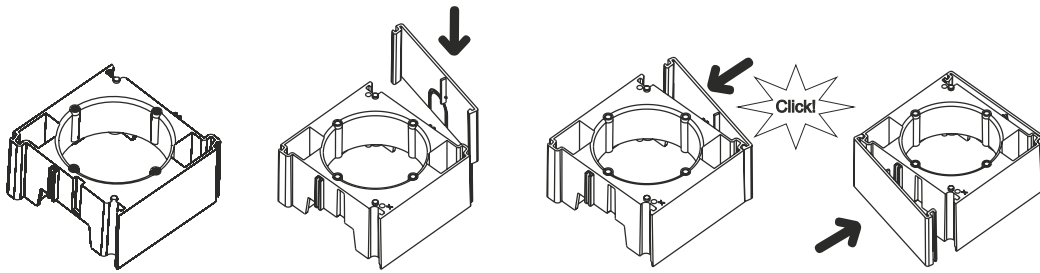

Multi-gang mounting

(EPH61001xx + EPH61002xx)

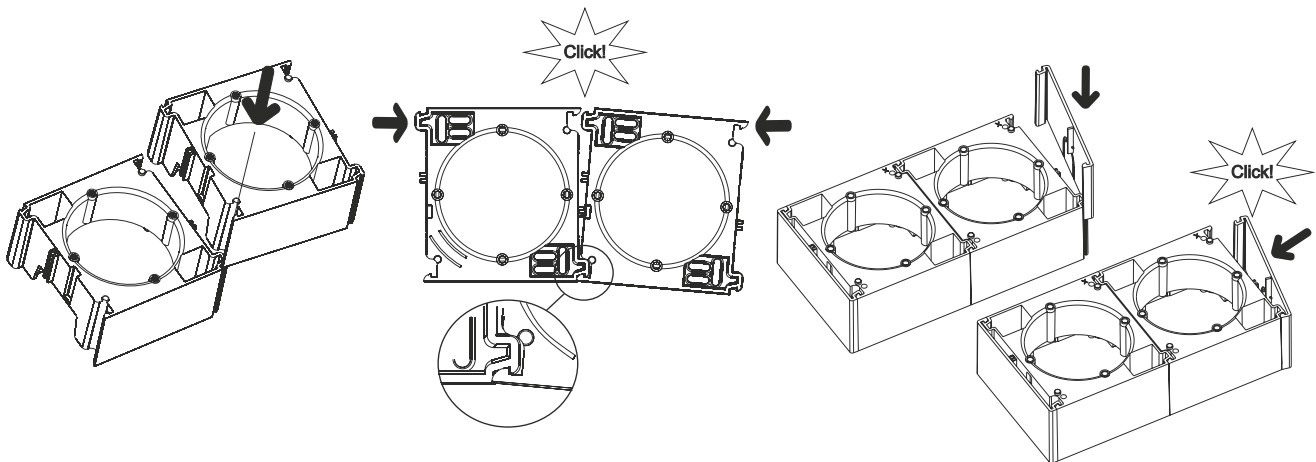

Mounting with TV/R, TV/SAT, TV/R/SAT outlets

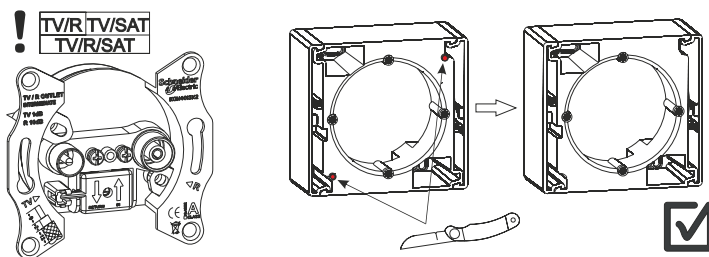

Technical information

Dimensions

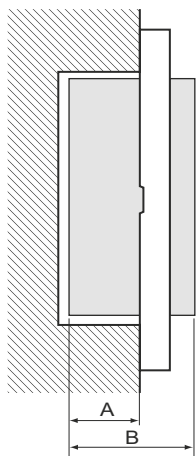

A: Embedding depth
B: Depth

Ref.	A (mm)	B (mm)	Ref.	A (mm)	B (mm)	Ref.	A (mm)	B (mm)	Ref.	A (mm)	B (mm)
EPH01001xx	28	43	EPH13001xx	28	43	EPH29005xx	32	42	EPH41001xx	29	38
EPH01002xx	28	43	EPH13003xx	28	43	EPH30001xx	32	42	EPH42001xx	29	38
EPH01003xx	28	43	EPH13005xx	28	43	EPH31001xx	32	47	EPH43001xx	27	36
EPH02001xx	28	43	EPH14001xx	28	43	EPH31003xx	32	42	EPH44001xx	27	36
EPH02003xx	28	43	EPH14003xx	28	43	EPH32001xx	28	38	EPH47001xx	27	36
EPH03001xx	28	43	EPH14303xx	28	43	EPH32002xx	28	38	EPH48001xx	27	36
EPH03003xx	28	43	EPH15001xx	28	43	EPH32003xx	28	38	EPH49001xx	27	36
EPH04001xx	28	43	EPH15003xx	28	43	EPH33001xx	28	38	EPH50001xx	39	48
EPH04003xx	28	43	EPH16001xx	28	43	EPH33002xx	28	38	EPH56001xx	26	35
EPH04004xx	28	43	EPH16003xx	28	43	EPH33003xx	28	38	EPH57001xx	26	43
EPH05001xx	28	43	EPH17001xx	28	43	EPH34001xx	29	42	EPH62001xx	29	52
EPH05003xx	28	43	EPH17003xx	28	43	EPH34002xx	29	42	EPH63001xx	29	52
EPH06001xx	28	43	EPH18001xx	28	43	EPH34003xx	29	42	EPH64001xx	29	49
EPH06003xx	28	43	EPH19003xx	28	43	EPH34004xx	29	42	EPH65001xx	29	49
EPH07001xx	28	43	EPH28001xx	32	42	EPH35001xx	29	42	EPH66001xx	29	49
EPH08001xx	28	43	EPH28002xx	32	42	EPH35002xx	29	42	EPH97001xx	23	46
EPH08003xx	28	43	EPH28003xx	32	48	EPH35003xx	29	42	EPH97002xx	23	46
EPH09001xx	28	43	EPH28004xx	32	42	EPH36001xx	29	42	EPH98001xx	23	46
EPH11001xx	28	43	EPH29001xx	32	42	EPH37001xx	29	42	EPH98002xx	23	46
EPH11003xx	28	43	EPH29002xx	32	42	EPH37002xx	29	42	EPH99001xx	23	46

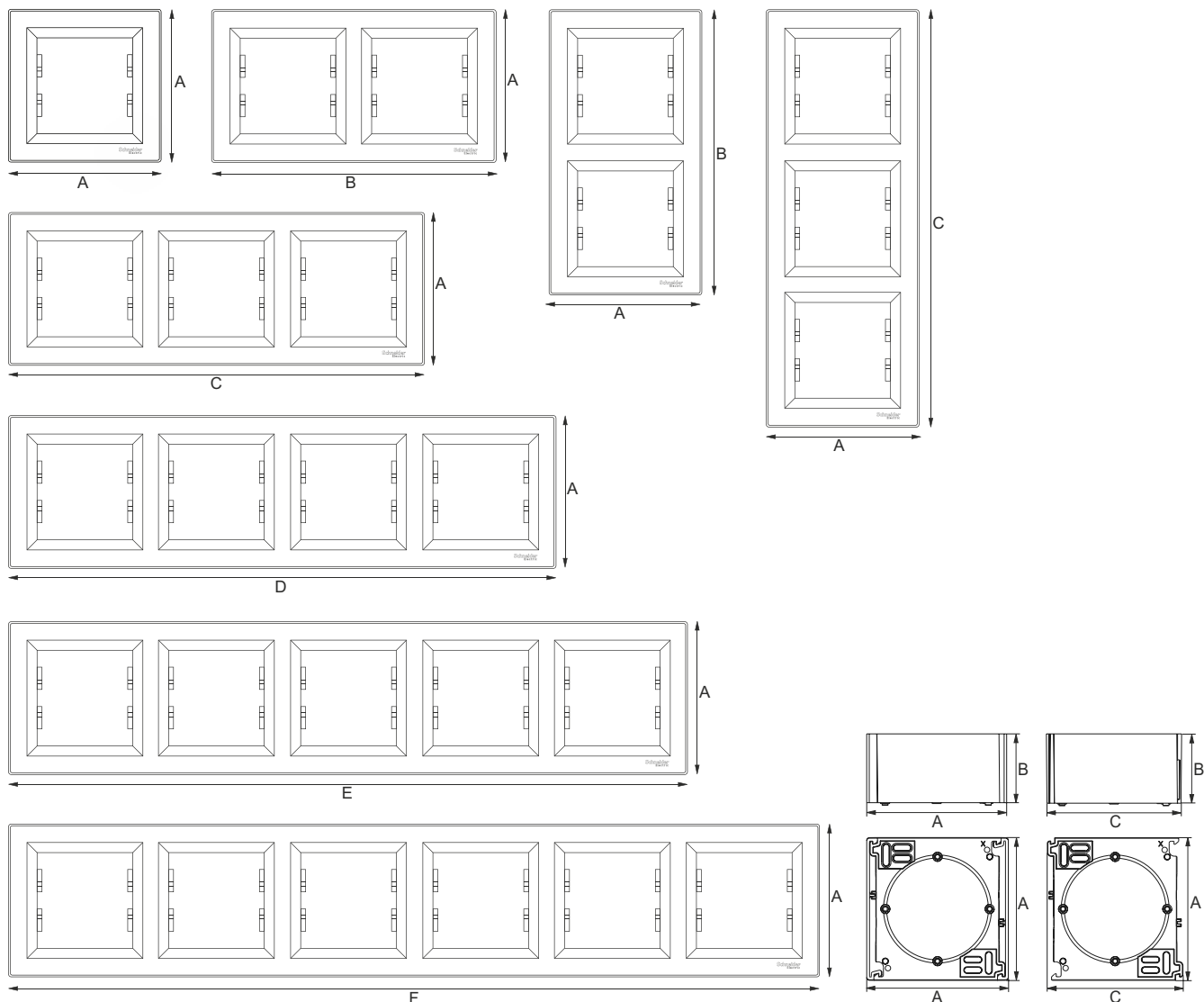

Horizontal and vertical frames (mm)

1 gang	2 gang	3 gang	4 gang	5 gang	6 gang
A	B	C	D	E	F
83	154	225	296	367	439

Surface-mounted boxes (mm)

1 gang	Extension			
A	B	A	B	C
82	40	82	40	78

Reference numbers

Overview

Ref.	Pages	Ref.	Pages	Ref.	Pages	Ref.	Pages	Ref.	Pages
EPH0100121	10	EPH0400323	10	EPH0800321	12	EPH1400169	11	EPH1700362	13
EPH0100123	10	EPH0400361	10	EPH0800323	12	EPH1400171	11	EPH1700369	13
EPH0100161	10	EPH0400362	10	EPH0800361	12	EPH14001xx	25	EPH1700371	13
EPH0100162	10	EPH0400369	10	EPH0800362	12	EPH1400321	11	EPH17003xx	25
EPH0100169	10	EPH0400371	10	EPH0800369	12	EPH1400323	11	EPH1770121	13
EPH0100171	10	EPH04003xx	25	EPH0800371	12	EPH1400361	11	EPH1770123	13
EPH01001xx	25	EPH0400421	10	EPH08003xx	25	EPH1400362	11	EPH1800121	13
EPH0100221	10	EPH0400423	10	EPH0870121	12	EPH1400369	11	EPH1800123	13
EPH0100223	10	EPH0400461	10	EPH0870123	12	EPH1400371	11	EPH1800161	13
EPH0100261	10	EPH0400462	10	EPH0900121	12	EPH14003xx	25	EPH1800162	13
EPH0100262	10	EPH0400469	10	EPH0900123	12	EPH1430321	11	EPH1800169	13
EPH0100269	10	EPH0400471	10	EPH0900161	12	EPH1430323	11	EPH1800171	13
EPH0100271	10	EPH04004xx	25	EPH0900162	12	EPH1430361	11	EPH18001xx	25
EPH01002xx	25	EPH0470121	10	EPH0900169	12	EPH1430362	11	EPH1870121	13
EPH0100321	10	EPH0470123	10	EPH0900171	12	EPH1430369	11	EPH1870123	13
EPH0100323	10	EPH0500121	10	EPH09001xx	25	EPH1430371	11	EPH1900121	13
EPH0100361	10	EPH0500123	10	EPH0970121	12	EPH14303xx	25	EPH1900123	13
EPH0100362	10	EPH0500161	10	EPH0970123	12	EPH1470121	11	EPH1900161	13
EPH0100369	10	EPH0500162	10	EPH1100121	12	EPH1470123	11	EPH1900162	13
EPH0100371	10	EPH0500169	10	EPH1100123	12	EPH1500121	11	EPH1900169	13
EPH01003xx	25	EPH0500171	10	EPH1100161	12	EPH1500123	11	EPH1900171	13
EPH0170121	10	EPH05001xx	25	EPH1100162	12	EPH1500161	11	EPH1900321	13
EPH0170123	10	EPH0500321	10	EPH1100169	12	EPH1500162	11	EPH1900323	13
EPH0200121	10	EPH0500323	10	EPH1100171	12	EPH1500169	11	EPH1900361	13
EPH0200123	10	EPH0500361	10	EPH11001xx	25	EPH1500171	11	EPH1900362	13
EPH0200161	10	EPH0500362	10	EPH1100321	12	EPH15001xx	25	EPH1900369	13
EPH0200162	10	EPH0500369	10	EPH1100323	12	EPH1500321	11	EPH1900371	13
EPH0200169	10	EPH0500371	10	EPH1100361	12	EPH1500323	11	EPH19003xx	25
EPH0200171	10	EPH05003xx	25	EPH1100362	12	EPH1500361	11	EPH2100121	10
EPH02001xx	25	EPH0570121	10	EPH1100369	12	EPH1500362	11	EPH2100123	10
EPH0200321	10	EPH0570123	10	EPH1100371	12	EPH1500369	11	EPH2100161	10
EPH0200323	10	EPH0600121	10	EPH11003xx	25	EPH1500371	11	EPH2100162	10
EPH0200361	10	EPH0600123	10	EPH1170121	12	EPH15003xx	25	EPH2100169	10
EPH0200362	10	EPH0600161	10	EPH1170123	12	EPH1570121	11	EPH2100171	10
EPH0200369	10	EPH0600162	10	EPH1300121	13	EPH1570123	11	EPH2170121	10
EPH0200371	10	EPH0600169	10	EPH1300123	13	EPH1600121	13	EPH2170123	10
EPH02003xx	25	EPH0600171	10	EPH1300161	13	EPH1600123	13	EPH2700221	18
EPH0270121	10	EPH06001xx	25	EPH1300162	13	EPH1600161	13	EPH2700223	18
EPH0270123	10	EPH0600321	10	EPH1300169	13	EPH1600162	13	EPH2700261	18
EPH0300121	10	EPH0600323	10	EPH1300171	13	EPH1600169	13	EPH2700262	18
EPH0300123	10	EPH0600361	10	EPH13001xx	25	EPH1600171	13	EPH2700269	18
EPH0300161	10	EPH0600362	10	EPH1300321	13	EPH16001xx	25	EPH2700271	18
EPH0300162	10	EPH0600369	10	EPH1300323	13	EPH1600321	13	EPH2700321	18
EPH0300169	10	EPH0600371	10	EPH1300361	13	EPH1600323	13	EPH2700323	18
EPH0300171	10	EPH06003xx	25	EPH1300362	13	EPH1600361	13	EPH2700361	18
EPH03001xx	25	EPH0670121	10	EPH1300369	13	EPH1600362	13	EPH2700362	18
EPH0300321	10	EPH0670123	10	EPH1300371	13	EPH1600369	13	EPH2700369	18
EPH0300323	10	EPH0700121	12	EPH13003xx	25	EPH1600371	13	EPH2700371	18
EPH0300361	10	EPH0700123	12	EPH1300521	11	EPH16003xx	25	EPH2800121	14
EPH0300362	10	EPH0700161	12	EPH1300523	11	EPH1601521	13	EPH2800123	14
EPH0300369	10	EPH0700162	12	EPH1300561	11	EPH1601523	13	EPH2800161	14
EPH0300371	10	EPH0700169	12	EPH1300562	11	EPH1670121	13	EPH2800162	14
EPH03003xx	25	EPH0700171	12	EPH1300569	11	EPH1670123	13	EPH2800169	14
EPH0370121	10	EPH07001xx	25	EPH1300571	11	EPH1700121	13	EPH2800171	14
EPH0370123	10	EPH0770121	12	EPH13005xx	25	EPH1700123	13	EPH28001xx	25
EPH0400121	10	EPH0770123	12	EPH1370121	13	EPH1700161	13	EPH2800221	14
EPH0400123	10	EPH0800121	12	EPH1370123	13	EPH1700162	13	EPH2800223	14
EPH0400161	10	EPH0800123	12	EPH1370521	11	EPH1700169	13	EPH2800261	14
EPH0400162	10	EPH0800161	12	EPH1370523	11	EPH1700171	13	EPH2800262	14
EPH0400169	10	EPH0800162	12	EPH1400121	11	EPH17001xx	25	EPH2800269	14
EPH0400171	10	EPH0800169	12	EPH1400123	11	EPH1700321	13	EPH2800271	14
EPH04001xx	25	EPH0800171	12	EPH1400161	11	EPH1700323	13	EPH28002xx	25
EPH0400321	10	EPH08001xx	25	EPH1400162	11	EPH1700361	13	EPH2800321	14

Reference numbers

Overview

Ref.	Pages	Ref.	Pages	Ref.	Pages	Ref.	Pages	Ref.	Pages
EPH2800323	14	EPH3200121	16	EPH34001xx	22	EPH36001xx	25	EPH4700169	17
EPH2800361	14	EPH3200123	16	EPH34001xx	25	EPH3670121	16	EPH4700171	17
EPH2800362	14	EPH3200161	16	EPH3400221	16	EPH3670123	16	EPH47001xx	25
EPH2800369	14	EPH3200162	16	EPH3400223	16	EPH36701xx	22	EPH4770121	17
EPH2800371	14	EPH3200169	16	EPH3400261	16	EPH3700121	16	EPH4770123	17
EPH28003xx	25	EPH3200171	16	EPH3400262	16	EPH3700123	16	EPH4800121	17
EPH2800421	14	EPH32001xx	22	EPH3400269	16	EPH3700161	16	EPH4800123	17
EPH2800423	14	EPH32001xx	25	EPH3400271	16	EPH3700162	16	EPH4800161	17
EPH28004xx	25	EPH3200221	16	EPH34002xx	22	EPH3700169	16	EPH4800162	17
EPH2800621	14	EPH3200223	16	EPH34002xx	25	EPH3700171	16	EPH4800169	17
EPH2800623	14	EPH3200261	16	EPH3400321	16	EPH37001xx	22	EPH4800171	17
EPH2800661	14	EPH3200262	16	EPH3400323	16	EPH37001xx	25	EPH48001xx	25
EPH2800662	14	EPH3200269	16	EPH3400361	16	EPH3700221	16	EPH4870121	17
EPH2800669	14	EPH3200271	16	EPH3400362	16	EPH3700223	16	EPH4870123	17
EPH2800671	14	EPH32002xx	22	EPH3400369	16	EPH3700261	16	EPH4900121	17
EPH2870121	14	EPH32002xx	25	EPH3400371	16	EPH3700262	16	EPH4900123	17
EPH2870123	14	EPH3200321	16	EPH34003xx	22	EPH3700269	16	EPH4900161	17
EPH2870442	14	EPH3200323	16	EPH34003xx	25	EPH3700271	16	EPH4900162	17
EPH2900121	15	EPH3200361	16	EPH3400421	16	EPH37002xx	22	EPH4900169	17
EPH2900123	15	EPH3200362	16	EPH3400423	16	EPH37002xx	25	EPH4900171	17
EPH2900161	15	EPH3200369	16	EPH3400461	16	EPH3770121	16	EPH49001xx	25
EPH2900162	15	EPH3200371	16	EPH3400462	16	EPH3770123	16	EPH5000121	17
EPH2900169	15	EPH32003xx	22	EPH3400469	16	EPH37701xx	22	EPH5000123	17
EPH2900171	15	EPH32003xx	25	EPH3400471	16	EPH4100121	17	EPH5000161	17
EPH29001xx	25	EPH3270121	16	EPH34004xx	22	EPH4100123	17	EPH5000162	17
EPH2900221	15	EPH3270123	16	EPH34004xx	25	EPH4100161	17	EPH5000169	17
EPH2900223	15	EPH32701xx	22	EPH3470121	16	EPH4100162	17	EPH5000171	17
EPH2900261	15	EPH3270321	16	EPH3470123	16	EPH4100169	17	EPH50001xx	25
EPH2900262	15	EPH3270323	16	EPH34701xx	22	EPH4100171	17	EPH5200121	17
EPH2900269	15	EPH32703xx	22	EPH3470321	16	EPH41001xx	25	EPH5200123	17
EPH2900271	15	EPH3300121	16	EPH3470323	16	EPH4170121	17	EPH5200161	17
EPH29002xx	25	EPH3300123	16	EPH34703xx	22	EPH4170123	17	EPH5200162	17
EPH2900521	15	EPH3300161	16	EPH3500121	16	EPH4200121	17	EPH5200169	17
EPH2900523	15	EPH3300162	16	EPH3500123	16	EPH4200123	17	EPH5200171	17
EPH29005xx	25	EPH3300169	16	EPH3500161	16	EPH4200161	17	EPH5270121	17
EPH2970121	15	EPH3300171	16	EPH3500162	16	EPH4200162	17	EPH5270123	17
EPH2970123	15	EPH33001xx	22	EPH3500169	16	EPH4200169	17	EPH5500121	15
EPH2970221	15	EPH33001xx	25	EPH3500171	16	EPH4200171	17	EPH5500123	15
EPH2970223	15	EPH3300221	16	EPH35001xx	22	EPH42001xx	25	EPH5500161	15
EPH2970542	15	EPH3300223	16	EPH35001xx	25	EPH4270121	17	EPH5500162	15
EPH3000121	14	EPH3300261	16	EPH3500221	16	EPH4270123	17	EPH5500169	15
EPH3000123	14	EPH3300262	16	EPH3500223	16	EPH4300121	17	EPH5500171	15
EPH3000161	14	EPH3300269	16	EPH3500261	16	EPH4300123	17	EPH5600121	19
EPH3000162	14	EPH3300271	16	EPH3500262	16	EPH4300161	17	EPH5600123	19
EPH3000169	14	EPH33002xx	22	EPH3500269	16	EPH4300162	17	EPH5600161	19
EPH3000171	14	EPH33002xx	25	EPH3500271	16	EPH4300169	17	EPH5600162	19
EPH30001xx	25	EPH3300321	16	EPH35002xx	22	EPH4300171	17	EPH5600169	19
EPH3100121	15	EPH3300323	16	EPH35002xx	25	EPH43001xx	25	EPH5600171	19
EPH3100123	15	EPH3300361	16	EPH3500321	16	EPH4370121	17	EPH56001xx	25
EPH3100161	15	EPH3300362	16	EPH3500323	16	EPH4370123	17	EPH5670121	19
EPH3100162	15	EPH3300369	16	EPH3500361	16	EPH4400121	17	EPH5670123	19
EPH3100169	15	EPH3300371	16	EPH3500362	16	EPH4400123	17	EPH5700121	17
EPH3100171	15	EPH33003xx	22	EPH3500369	16	EPH4400161	17	EPH5700123	17
EPH31001xx	25	EPH33003xx	25	EPH3500371	16	EPH4400162	17	EPH5700161	17
EPH3100321	15	EPH3300721	16	EPH35003xx	22	EPH4400169	17	EPH5700162	17
EPH3100323	15	EPH3300723	16	EPH35003xx	25	EPH4400171	17	EPH5700169	17
EPH3100361	15	EPH33007xx	22	EPH3600121	16	EPH44001xx	25	EPH5700171	17
EPH3100362	15	EPH3400121	16	EPH3600123	16	EPH4470121	17	EPH57001xx	25
EPH3100369	15	EPH3400123	16	EPH3600161	16	EPH4470123	17	EPH5770121	17
EPH3100371	15	EPH3400161	16	EPH3600162	16	EPH4700121	17	EPH5770123	17
EPH31003xx	25	EPH3400162	16	EPH3600169	16	EPH4700123	17	EPH5800121	19
EPH3170121	15	EPH3400169	16	EPH3600171	16	EPH4700161	17	EPH5800123	19
EPH3170123	15	EPH3400171	16	EPH36001xx	22	EPH4700162	17	EPH5800161	19

Reference numbers

Overview

Ref.	Pages	Ref.	Pages	Ref.	Pages
EPH5800162	19	EPH6270121	11	EPH9900121	15
EPH5800169	19	EPH6270123	11	EPH9900123	15
EPH5800171	19	EPH63001xx	25	EPH9900161	15
EPH5800221	19	EPH6400121	18	EPH9900162	15
EPH5800223	19	EPH6400123	18	EPH9900169	15
EPH5800261	19	EPH6400161	18	EPH9900171	15
EPH5800262	19	EPH6400162	18	EPH99001xx	25
EPH5800269	19	EPH6400169	18		
EPH5800271	19	EPH6400171	18		
EPH5800321	19	EPH64001xx	25		
EPH5800323	19	EPH6470121	18		
EPH5800361	19	EPH6470123	18		
EPH5800362	19	EPH6500121	18		
EPH5800369	19	EPH6500123	18		
EPH5800371	19	EPH6500161	18		
EPH5800421	19	EPH6500162	18		
EPH5800423	19	EPH6500169	18		
EPH5800461	19	EPH6500171	18		
EPH5800462	19	EPH65001xx	25		
EPH5800469	19	EPH6570121	18		
EPH5800471	19	EPH6570123	18		
EPH5800521	19	EPH6600121	18		
EPH5800523	19	EPH6600123	18		
EPH5800561	19	EPH6600161	18		
EPH5800562	19	EPH6600162	18		
EPH5800569	19	EPH6600169	18		
EPH5800571	19	EPH6600171	18		
EPH5800621	19	EPH66001xx	25		
EPH5800623	19	EPH6670121	18		
EPH5800661	19	EPH6670123	18		
EPH5800662	19	EPH9700121	14		
EPH5800669	19	EPH9700123	14		
EPH5800671	19	EPH9700161	14		
EPH5810221	19	EPH9700162	14		
EPH5810223	19	EPH9700169	14		
EPH5810261	19	EPH9700171	14		
EPH5810262	19	EPH97001xx	25		
EPH5810269	19	EPH9700221	14		
EPH5810271	19	EPH9700223	14		
EPH5810321	19	EPH9700261	14		
EPH5810323	19	EPH9700262	14		
EPH5810361	19	EPH9700269	14		
EPH5810362	19	EPH9700271	14		
EPH5810369	19	EPH97002xx	25		
EPH5810371	19	EPH9800121	14		
EPH6100121	19	EPH9800123	14		
EPH6100123	19	EPH9800161	14		
EPH6100161	19	EPH9800162	14		
EPH6100162	19	EPH9800169	14		
EPH6100169	19	EPH9800171	14		
EPH6100171	19	EPH98001xx	25		
EPH6100221	19	EPH9800221	14		
EPH6100223	19	EPH9800223	14		
EPH6100261	19	EPH9800261	14		
EPH6100262	19	EPH9800262	14		
EPH6100269	19	EPH9800269	14		
EPH6100271	19	EPH9800271	14		
EPH6200121	11	EPH98002xx	25		
EPH6200123	11	EPH9810221	14		
EPH6200161	11	EPH9810223	14		
EPH6200162	11	EPH9810261	14		
EPH6200169	11	EPH9810262	14		
EPH6200171	11	EPH9810269	14		
EPH62001xx	25	EPH9810271	14		



Green Premium™

Endorsing eco-friendly products in the industry



Green Premium™

Product

Green Premium is the only label that allows you to effectively develop and promote an environmental policy whilst preserving your business efficiency. This ecolabel guarantees compliance with up-to-date environmental regulations, but it does more than this.

Over 75% of Schneider Electric manufactured products have been awarded the Green Premium ecolabel



Discover what we mean by green ...

Check your products!

Schneider Electric's Green Premium ecolabel is committed to offering transparency, by disclosing extensive and reliable information related to the environmental impact of its products:

RoHS

Schneider Electric products are subject to RoHS requirements at a worldwide level, even for the many products that are not required to comply with the terms of the regulation. Compliance certificates are available for products that fulfil the criteria of this European initiative, which aims to eliminate hazardous substances.

REACH

Schneider Electric applies the strict REACH regulation on its products at a worldwide level, and discloses extensive information concerning the presence of SVHC (Substances of Very High Concern) in all of its products.

PEP: Product Environmental Profile

Schneider Electric publishes complete set of environmental data, including carbon footprint and energy consumption data for each of the lifecycle phases on all of its products, in compliance with the ISO 14025 PEP ecopassport program. PEP is especially useful for monitoring, controlling, saving energy, and/or reducing carbon emissions.

EoLI: End of Life Instructions

Available at the click of a button, these instructions provide:

- Recyclability rates for Schneider Electric products.
- Guidance to mitigate personnel hazards during the dismantling of products and before recycling operations.
- Parts identification for recycling or for selective treatment, to mitigate environmental hazards/ incompatibility with standard recycling processes.

Life Is On | **Schneider**
Electric

