

Installation manual

# PV Solar MODULE

Please read this manual carefully before operating your set and retain it for future reference.

**N-TYPE MODELS**

LGXXN1C(W,K)-G4

LGXXN2C(W)-G4

**P-TYPE MODELS**

LGXXS1C(W)-G4

LGXXS2C(W)-G4



MFL69534401 (Rev 01)

[www.lgsolarusa.com](http://www.lgsolarusa.com)

# TABLE OF CONTENTS

<b>SAFETY</b> .....	<b>03</b>
<b>BEFORE &amp; AFTER INSTALLATION</b> .....	<b>05</b>
Before Installation.....	05
After Installation.....	05
<b>ELECTRICAL INSTALLATION</b> .....	<b>06</b>
Danger.....	06
Electrical Connections.....	06
Diodes .....	06
Series Connection .....	06
Parallel Connection .....	07
General Wiring.....	07
Earth Grounding .....	07
<b>MECHANICAL INSTALLATION</b> .....	<b>08</b>
Module Mounting.....	08
Site Consideration .....	08
Mounting Methods.....	08
<b>DISCLAIMER OF LIABILITY / DISPOSAL</b> .....	<b>10</b>
<b>TRANSPORTING AND STORAGE</b> .....	<b>10</b>
<b>REVISIONS TABLE</b> .....	<b>10</b>
<b>PRODUCT SPECIFICATIONS</b> .....	<b>11</b>
Electrical & Mechanical Properties.....	11
Dimensions of Modules .....	13
<b>APPENDIX</b> .....	<b>14</b>

# SAFETY

The instructions related to safety and use indicated in the this installation manual are intended for the prevention of unexpected danger, damage, or failure.

**⚠ DANGER**   **⚠ WARNING**   **⚠ CAUTION**

Non-compliance with the instructions may cause product damage, product failure, and/or serious bodily injury or death.

**⚠ DANGER**

Do not contact electrically active parts of the panel, such as terminals, without appropriate safety gear. Contact may result in lethal spark or electric shock.

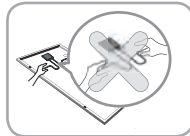

Do not use or install if the module is broken or torn. Failure to comply may result in electric shock.

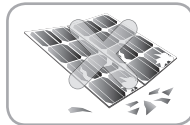

**⚠ WARNING**

Perform all work in dry conditions and use only dry tools. Do not handle wet panels without appropriate protection equipment. Failure to comply may result in accident or death.



Damaged modules must be treated with safety protection equipment. Failure to comply may result in serious bodily injury or death.

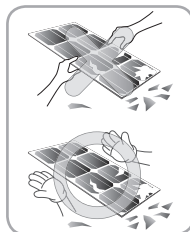

Do not approach the damaged or broken module unless you are an authorized or qualified expert. Failure to comply may result in serious bodily injury or death.

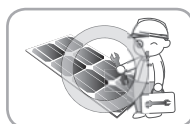

No electrical parts like cables are located after installation between laminate and mounting structure.



Do Not reconnect or repair junction box cable. It may occur spark or electric shock.

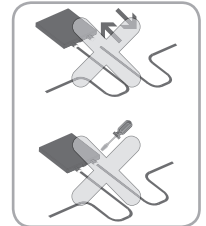

Do not bending junction box's cable. While under stress, it may occur module damage. Cable bending radius should be more than 4 times the cable diameter, at least.

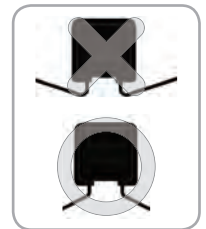

**⚠ CAUTION**

Use proper equipment, connectors, wires and buttresses for the installation of the module. Failure to comply may result in product damage, product failure or bodily injury.

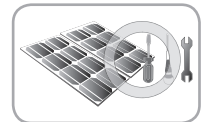

Installation during rain, heavy wind or snowy day may result in bodily injury or death.

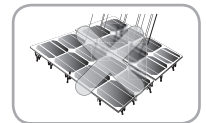

Holes in the frame or glass of the module may decrease the strength of the frame or break the glass.



Do not touch the glass surface or frame of the solar module after installation of the module. It may result in injury or death.

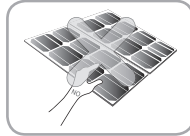

Heavy objects must be kept off of the solar module.

Do not stand on or step on the module. Do not drop the module.

Failure to comply may result in product damage, product failure or bodily injury.



Do not scratch the coating surface of the frame.

Scratches may decrease the total solar output due to corrosion of the frame.

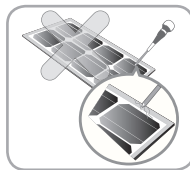

Do not artificially concentrate sunlight on the solar module surface. Failure to comply may result in product damage or failure.

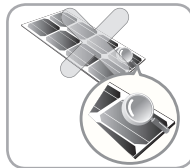

Do not apply a shock to the junction box of the module or pull the cable. Do not remove the labels attached to the module.

Failure to comply may result in damage of the product.

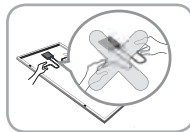

If the installing modules on curved surface, (e. g. arch type), as shown in the below picture, do not forcefully modify the module in the installation when connecting it with the structure. Only install the module in the place where the structure for the panels has been properly set up. An improper structure may cause deformation of the panels. Panels may also be damaged by unapproved installation methods such as the use of a crane.

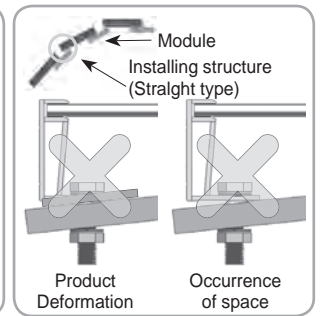
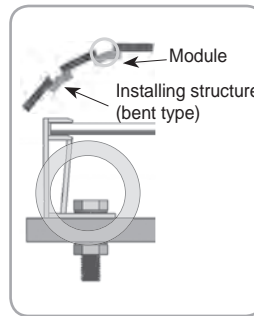

# BEFORE & AFTER INSTALLATION

## Before Installation

Please carefully read this manual before installation.

- Solar module installation and maintenance must be performed by qualified and authorized installer.
- All installation instructions should be read and understood before performing any installation.
- Do not disassemble the solar module.
- After installation or repair, check that the solar module are operating properly.
- In the event that the currently used solar module or parts have been replaced the newly replaced module and parts must have the same model name and parts as the previously installed solar module.
- Secure all necessary permits and licenses to install the solar modules.
- Panels are not intended for use indoors or on moving vehicles of any kind.
- Industry standard rated specifications are made at conditions of 1000W/m<sup>2</sup> irradiance and 25°C (77°F) solar cell temperature. Colder temperatures may substantially increase voltage and power.
- Keep the solar module and system away from children at all times.
- Keep the module packed in the carton until the time of installation.
- Keep flammable gasses away from the installation site.
- Do not work alone. Please work as part of a team of two or more people.
- Safety harness use is strongly recommended for installation.
- Partial shadowing may substantially reduce panel and system output.
- Care must be taken to avoid low tilt angles which may cause dirt to buildup on the glass against the frame edge.
- Dirt build-up on the surface of the panel may cause active solar cells to be shaded and electrical performance to be impaired.

## After Installation

- Plug in the connector tightly and ensure that the wiring properly works.
- Conduct periodic inspection of the panels for damage to front glass, back sheet, frame, junction box, or external electrical connections.
- Check electrical connections for loose connections and corrosion.
- Water, ethanol or a conventional glass cleanser with a micro-fiber cloth can be used for regular washing or rinsing of the front glass to remove dust, dirt or other deposits.
- Aggressive and abrasive cleansers or chemicals such as alkali chemicals including ammonia based solution should not be used on cleaning the module.
- Deposits of foreign material on the frame surface can be cleaned by using a wet sponge or cloth and dried in air or by using a clean chamois.
- Perform the wiring work by connecting the connector and wires to the stand away from the roof or ground.

# ELECTRICAL INSTALLATION

## Danger

- Avoid all electrical hazards when installing, wiring, operating and maintaining all panels.
- Do not connect panels that have different electrical properties or physical configurations in the same system.
- Match the polarities of cables and terminals when making the connections; failure to do so may result in damage to the panel.
- The rating of the over-current device shall not exceed the maximum series fuse rating marked on the name plate.
- The panel contains factory installed bypass diodes located inside the junction box.
- When installing the system, it is recommended to install a lightning rod to protect the system.
- The induced overvoltage by lightning can cause the system damage, you should design conductor loop connection as minimum as possible.
- The junction box should not be opened. Opening the junction box will void the warranty.
- Panels with a suspected electrical problem should be returned to LG Electronics for inspection and possible repair or replacement as per the warranty conditions provided by LG Electronics.

## Electrical Connections

- Shock hazard may occur near the solar modules electrical connections.
- Modules may be connected in series and/or parallel to achieve the desired electrical output as long as it is within the guidelines on the product specification sheet.
- Please use only the same type of modules in a combined source circuit.
- Do not disconnect the module under when it is operating. Shock hazard may occur near the solar modules connection means.
- When the module installing in series or in parallel (e.g. using for extension cables), the connector of each module should be the same products.

## Diodes

- All LG modules are equipped with factory installed bypass diodes. The factory-installed diodes provide proper circuit protection for the systems within the specified system voltage.

$I_F$ (AV)	25A
$V_F$ (max)	0.6V
$V_{RRM}$	50V
$T_j$ (max)	200°C
$R_{TH}$	2.0°C/W

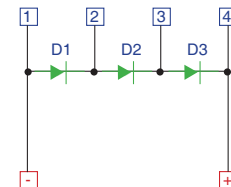

Diode specification and configuration

## Series Connection

- The solar modules may be wired in series to produce the desired voltage output.
- The current of each module connected in series should be the same.
- The maximum PV system voltage for that circuit shall be calculated as the sum of the rated open-circuit voltage of the series-connected PV modules corrected for the lowest expected ambient temperature. For the LG Mono crystalline modules, the rated open-circuit voltage shall be multiplied by the correction factor provided in NEC Table 690.7. The maximum current of Photovoltaic Source Circuit Currents shall be the rated short-circuit current of the series-connected module multiplied by 125 percent in accordance with NEC article 690.8.

## Parallel Connection

- The solar modules may be combined in parallel to produce the desired current output.
- When modules are combined in parallel, the total current is equal to the sum of currents from each module.
- The voltage of each module connected in parallel should be the same.
- When connecting plural strings of modules in parallel every series string or solar module must be fused prior to combining with other strings.
- Abide with all applicable federal, state, and local codes for additional fusing requirements and limitations on the maximum number of solar modules in parallel.
- Maximum series fuse rating is refer to “Product Specifications; page 9~10”.
- Parallel configuration is not limited if proper measures are taken to block the reverse current flow, e.g. fuses for the protection of the module and cables from over-current for prevention of unbalanced string voltage.
- A multiplying factor is required for increased output of the PV modules. Under normal conditions, a PV module is likely to experience conditions that produce more current and/or voltage than reported at standard test conditions. The requirements of the National Electrical Code (NEC) in Article 690 shall be followed to address these increased outputs. In installations not under the requirements of the NEC, the values of  $I_{sc}$  and  $V_{oc}$  marked on this PV module should be multiplied by a factor of 125% when determining component voltage ratings, conductor ampacities, fuse sizes, and size of controls to the PV output.
- Depending on national directives, additional safety factors might be applicable for over current protection.

## General Wiring

- LG Electronics recommends that all wiring be double insulated with a minimum rating of 90°C (194°F).
- All wiring should use a flexible copper (Cu) conductor.
- The minimum size should be determined by the applicable codes.
- LG Electronics recommends a size no smaller than 12AWG.

## Earth Grounding

- All work must be conducted in conformance with all Federal, State, and local codes and standards.
- Grounding works should be performed by an authorized installer for the safety and maintenance of the system in accordance with all national, state and local electrical codes and regulations and standards.
- Specific information on the solar module dimensions and location of grounding holes is provided in “Product Specifications”.
- One M4 stainless steel bolt, one nut, one spring washer, two flat washers, one cup washer, one star washer and 12 AWG Cu wires are recommended per mounting hole.
- Where common grounding hardware (nut, bolts, washers) is used to attach a listed grounding device, the attachment must be made in conformance with the grounding device manufacturer’s instructions.
- All hardware should be consist of corrosion resistant material such as stainless steel.
- There is an earth hole on the edge of the module frame. Using this hole, an earth conductor and the solar module frame may be recommended to be connected and earthed as the below drawing.
- All screws and nuts shall be tightened to a torque of 4~5 N·m.
- A module with exposed conductive parts is considered to be in compliance with UL 1703 only when is electrically grounded in accordance with the instructions presented below and the requirements of the National Electrical Code.

The installation instructions shall include:

1. Details for wiring shall comply the NEC Article 690.
2. Details for the grounding method of the frame of arrays shall comply with the NEC Article 250.
3. CNL model instruction manuals shall also include a statement that installation shall be in accordance with CSA C22.1, Safety Standard for Electrical Installations, Canadian Electrical Code, Part 1.

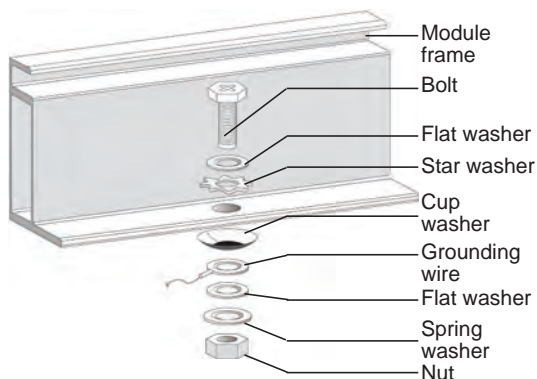

# MECHANICAL INSTALLATION

## Module Mounting

- The LG Electronics' (LGE) Limited Warranty for solar modules is contingent upon modules being mounted in accordance with the requirements described in this section.
- Any module without a frame (laminated) shall not be considered to comply with the requirements of UL 1703 unless the module with hardware that has been tested and evaluated with the module under this standard or by a field inspection certifying that the installed module complies with the requirements of UL 1703.
- We recommend to use mounting device (bolt, nut, washer) made by corrosion resistant material like stainless steel.

## Site Consideration

LGE solar modules should be mounted in a location that meets the following requirements.

### Operating Temperature

- Maximum Operating Temperature: +90°C (194°F)
- Minimum Operating Temperature: -40°C (-40°F)

### Design Strength (Basic Load)

- 60Cell Modules : 75lb/ft<sup>2</sup>
- 72Cell Modules : 60lb/ft<sup>2</sup>
- Detail of mounting distance is below.

	60Cell	① : 170mm (6.7in) ② : 270mm (10.6in)
	72Cell	① : 270mm (10.6in) ② : 370mm (14.6in)

### Excluded Operating Environments

- The solar modules from LG Electronics can not be operated in a location where they could come in direct contact with salt water or ammonia.

## Mounting Methods

### General Information

- Select the appropriate orientation to maximize sunlight exposure.
- Module should not be mounted or stored in a way that the front/top glass faces downward in order to prevent water from entering the junction box, which could cause a safety hazard.
- Clearance between the solar module frames and structures such as roofs or ground is required to prevent wiring damage and to allow air to circulate behind the solar module. The recommended standoff height is a minimum of 100mm.
- When installed on a roof, the solar module must be mounted over a fire-resistant roof covering rated for the application. The fire resistance of the solar module is class C after ANSI/UL790 Edition 2004.
- A slope less than 5in/ft is required to maintain a fire class rating.
- The solar module is only ETL listed for use when its factory frame is fully intact.
- Removal or alteration must be done by an authorized and qualified individual.
- Creating additional mounting holes may damage the solar module and reduce the strength of the frame.
- We recommend a 6mm gap between module frames to avoid tension from thermal expansion.
- The fire rating of this module is valid only when mounted in the manner specified in the mechanical mounting instructions.
- The module is considered to be in compliance with UL1703 only when the module is mounted in the manner specified by the mounting instructions below.
- The solar module may be mounted by using the following methods: (\*Torque: 8~12N·m)
- LG modules (Fire performance : Type 1 or 2) shall be mounted with racking and mounting products certified and listed for system fire class rating in accordance with UL1703 edition 2014 and UL2703 edition 2014.
- It is recommended to check with local authorities for fire safety guidelines and requirements for any building or structure on to which the panels will be installed.



- When installing modules in heavy snow areas, it is recommended to be taken an appropriate countermeasure to prevent possible damages to the lower side frame by slipping snow.

We recommend to use corrosion resistant material according to standard UL 1703 or UL2703 for these supporting part. (A snow guard should be installed in accordance with the manufacturer's instructions.)

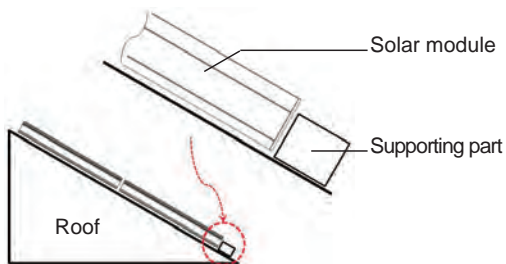

### Mounting by using frame bolts holes

- Secure the solar module to the structure by using the factory mounting holes.
- Four M8(5/16inch) stainless steel bolts, four nuts, four spring washers, and eight flat washers are recommended per solar module.
- The module may be fastened to a support by using both the outer and inner bolt holes of the frame.
- Each module should be securely fastened at a minimum 4 points on two opposite sides.
- Specific information on the solar module dimensions and location of mounting holes is provided in 'Product Specifications'.
- Tighten the bolt securely by using the combination shown above. Place the spring washer between the Flat washer and Nut.

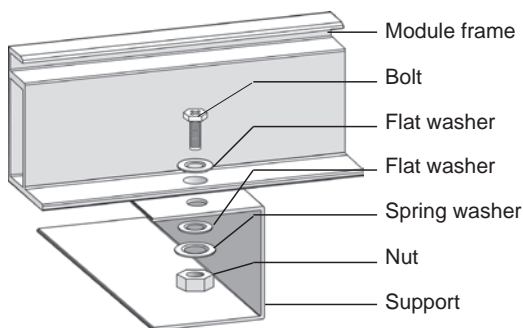

### Mounting by using clamps

- The module may be fastened to a support by using clamps on both the long edge and the short edge of the modules.
- Specific information on location of clamping is provided in 'Mechanical Installation Scene'. (Refer to Appendix.)
  - If you use a special clamp, it needs to test for compatibility by LGE.
- If the installation is likely to be affected by heavy(extreme) snow, further suitable panel support is recommended on the lower row of panels.

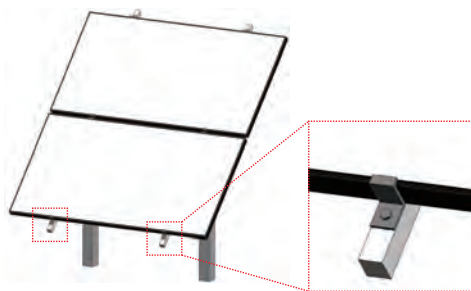

# DISCLAIMER OF LIABILITY / DISPOSAL

## Disclaimer of Liability

- By beginning to installation process, the installer has to read and completely understand this Installation Manual.
- If installer had any questions regarding this installation manual, the installer would have contacted LG with any questions or concerns.
- By installing an LG Solar module, I discharge, and covenant not to sue LG, its affiliated companies, successors, or assigns, its administrators, directors, agents, officers, volunteer and employees, other participants in any activity connected to installation, operation, or service of LG Solar Modules, and if applicable, from all liabilities, claims, demands, losses, or damages on my account caused or alleged to be caused in whole or in part by the negligence of the LG its affiliated companies, successors, or assigns, its administrators, directors, agents, officers, volunteer and employees.

## Disposal

- Please contact us, if you have any queries related to the disposal or recycling of solar modules from LG Electronics.

# TRANSPORTING AND STORAGE

- Do not loosen the banding, when the module is transported by truck, ship and etc. In case of loose banding, the module will be shaken, which may cause damage.
- Do not stack on more than one pallet. Maximum height is two pallets. Severe stacking can cause stress to the module and may cause product damage.

# REVISIONS TABLE

Date	Version	Description of change	Remark
2016.05.01	1.0 (1 <sup>st</sup> edition)	Universal Installation Manual	
2016.08.08	1.1	Edit to module's fire performance and Products line	

# PRODUCT SPECIFICATIONS

## N-TYPE

Electrical and Mechanical Properties(Rated electrical characteristics are -5 to +5 percent)  
Standard Test Condition(STC) : Irradiation 1000W/m<sup>2</sup>, Cell temp. 25°C, 1.5AM

Module Series	Model Name	Electrical Properties								Mechanical Properties				
		Pmax at STC	Power Tolerance	Voc at STC	Isc at STC	Vmpp at STC	Impp at STC	Max. Series Fuse Rating	Max. System Voltage	Connector	Length	Width	Height	Weight
		W	%	V	A	V	A	A	V		mm	mm	mm	kg
LGXXXN1C(W)-G4	LG280N1C(W)-G4	280	3%	38.6	9.78	30.7	9.13	20	1000	MC4	1640	1000	40	17.0
	LG285N1C(W)-G4	285	3%	38.9	9.81	31.1	9.17	20	1000	MC4	1640	1000	40	17.0
	LG290N1C(W)-G4	290	3%	39.2	9.84	31.4	9.24	20	1000	MC4	1640	1000	40	17.0
	LG295N1C(W)-G4	295	3%	39.5	9.87	31.8	9.28	20	1000	MC4	1640	1000	40	17.0
	LG300N1C(W)-G4	300	3%	39.8	9.90	32.2	9.34	20	1000	MC4	1640	1000	40	17.0
	LG305N1C(W)-G4	305	3%	40.1	9.93	32.5	9.39	20	1000	MC4	1640	1000	40	17.0
	LG310N1C(W)-G4	310	3%	40.4	9.96	32.8	9.45	20	1000	MC4	1640	1000	40	17.0
	LG315N1C(W)-G4	315	3%	40.6	10.02	33.2	9.50	20	1000	MC4	1640	1000	40	17.0
	LG320N1C(W)-G4	320	3%	40.9	10.05	33.6	9.53	20	1000	MC4	1640	1000	40	17.0
	LG325N1C(W)-G4	325	3%	41.2	10.08	34.0	9.57	20	1000	MC4	1640	1000	40	17.0
	LG330N1C(W)-G4	330	3%	41.5	10.11	34.3	9.63	20	1000	MC4	1640	1000	40	17.0
	LG335N1C(W)-G4	335	3%	41.8	10.14	34.6	9.69	20	1000	MC4	1640	1000	40	17.0
LG340N1C(W)-G4	340	3%	42.1	10.17	34.9	9.75	20	1000	MC4	1640	1000	40	17.0	
LGXXXN1K-G4	LG280N1K-G4	280	3%	38.1	9.53	31.0	9.04	20	1000	MC4	1640	1000	40	17.0
	LG285N1K-G4	285	3%	38.5	9.57	31.3	9.11	20	1000	MC4	1640	1000	40	17.0
	LG290N1K-G4	290	3%	38.9	9.61	31.7	9.16	20	1000	MC4	1640	1000	40	17.0
	LG295N1K-G4	295	3%	39.3	9.66	32.1	9.21	20	1000	MC4	1640	1000	40	17.0
	LG300N1K-G4	300	3%	39.7	9.70	32.5	9.26	20	1000	MC4	1640	1000	40	17.0
	LG305N1K-G4	305	3%	40.1	9.74	32.9	9.28	20	1000	MC4	1640	1000	40	17.0
	LG310N1K-G4	310	3%	40.5	9.78	33.3	9.31	20	1000	MC4	1640	1000	40	17.0
	LG315N1K-G4	315	3%	40.6	9.82	33.7	9.35	20	1000	MC4	1640	1000	40	17.0
	LG320N1K-G4	320	3%	40.9	9.86	34.1	9.39	20	1000	MC4	1640	1000	40	17.0
	LG325N1K-G4	325	3%	41.2	9.90	34.5	9.43	20	1000	MC4	1640	1000	40	17.0
LG330N1K-G4	330	3%	41.6	9.94	34.9	9.47	20	1000	MC4	1640	1000	40	17.0	
LGXXXN2C(W)-G4	LG360N2C(W)-G4	360	3%	47.4	9.86	38.6	9.33	20	1000	MC4	1960	1000	46	20.3
	LG365N2C(W)-G4	365	3%	47.7	9.92	38.9	9.39	20	1000	MC4	1960	1000	46	20.3
	LG370N2C(W)-G4	370	3%	48.0	9.98	39.2	9.44	20	1000	MC4	1960	1000	46	20.3
	LG375N2C(W)-G4	375	3%	48.3	10.04	39.5	9.50	20	1000	MC4	1960	1000	46	20.3
	LG380N2C(W)-G4	380	3%	48.6	10.10	39.8	9.55	20	1000	MC4	1960	1000	46	20.3
	LG385N2C(W)-G4	385	3%	48.9	10.16	40.1	9.61	20	1000	MC4	1960	1000	46	20.3
	LG390N2C(W)-G4	390	3%	49.2	10.22	40.4	9.67	20	1000	MC4	1960	1000	46	20.3
	LG395N2C(W)-G4	395	3%	49.5	10.27	40.7	9.73	20	1000	MC4	1960	1000	46	20.3

Note) MC4 formal name : PV-KST4 / 6II-UR, PV-KBT4 / 6II-UR

→ Plus (+) Connector : Female MC4 coupler (PV-KBT4/6II-UR)

→ Negative (-) Connector : Male MC4 coupler (PV-KST4/6II-UR)

The typical change in module efficiency at 200W/m<sup>2</sup> in relation to 1000W/m<sup>2</sup> is -2.0%(‘K Model’ is -3.0%)

A safety locking clip (MC PV-SSH4) may be required per article 690 of NEC 2008

## P-TYPE

Electrical and Mechanical Properties(Rated electrical characteristics are -5 to +5 percent)

Standard Test Condition(STC) : Irradiation 1000W/m<sup>2</sup>, Cell temp. 25°C, 1.5AM

		Electrical Properties								Mechanical Properties				
Module Series	Model Name	Pmax at STC	Power Tolerance	Voc at STC	Isc at STC	Vmpp at STC	Impp at STC	Max. Series Fuse Rating	Max. System Voltage	Connector	Length	Width	Height	Weight
		W	%	V	A	V	A	A	V		mm	mm	mm	kg
LGXXS1C(W)-G4	LG250S1C(W)-G4	250	3%	37.9	8.92	30.7	8.16	15	1000	MC4	1640	1000	40	17.0
	LG255S1C(W)-G4	255	3%	38.0	8.98	30.9	8.27	15	1000	MC4	1640	1000	40	17.0
	LG260S1C(W)-G4	260	3%	38.1	9.05	31.1	8.38	15	1000	MC4	1640	1000	40	17.0
	LG265S1C(W)-G4	265	3%	38.3	9.11	31.3	8.49	15	1000	MC4	1640	1000	40	17.0
	LG270S1C(W)-G4	270	3%	38.5	9.17	31.5	8.58	15	1000	MC4	1640	1000	40	17.0
	LG275S1C(W)-G4	275	3%	38.7	9.26	31.7	8.68	15	1000	MC4	1640	1000	40	17.0
	LG280S1C(W)-G4	280	3%	38.8	9.33	31.9	8.78	15	1000	MC4	1640	1000	40	17.0
	LG285S1C(W)-G4	285	3%	38.9	9.38	32.1	8.88	15	1000	MC4	1640	1000	40	17.0
	LG290S1C(W)-G4	290	3%	39.0	9.43	32.3	8.98	15	1000	MC4	1640	1000	40	17.0
	LG295S1C(W)-G4	295	3%	39.1	9.48	32.5	9.08	15	1000	MC4	1640	1000	40	17.0
	LG300S1C(W)-G4	300	3%	39.2	9.53	32.7	9.18	15	1000	MC4	1640	1000	40	17.0
LGXXS2C(W)-G4	LG300S2C(W)-G4	300	3%	44.8	9.02	36.2	8.30	20	1000	MC4	1960	1000	46	20.3
	LG305S2C(W)-G4	305	3%	45.0	9.09	36.4	8.39	20	1000	MC4	1960	1000	46	20.3
	LG310S2C(W)-G4	310	3%	45.2	9.15	36.6	8.48	20	1000	MC4	1960	1000	46	20.3
	LG315S2C(W)-G4	315	3%	45.4	9.22	36.8	8.57	20	1000	MC4	1960	1000	46	20.3
	LG320S2C(W)-G4	320	3%	45.6	9.28	37.0	8.66	20	1000	MC4	1960	1000	46	20.3
	LG325S2C(W)-G4	325	3%	45.8	9.35	37.2	8.75	20	1000	MC4	1960	1000	46	20.3
	LG330S2C(W)-G4	330	3%	46.0	9.41	37.3	8.85	20	1000	MC4	1960	1000	46	20.3
	LG335S2C(W)-G4	335	3%	46.2	9.48	37.5	8.94	20	1000	MC4	1960	1000	46	20.3
	LG340S2C(W)-G4	340	3%	46.4	9.54	37.7	9.02	20	1000	MC4	1960	1000	46	20.3
	LG345S2C(W)-G4	345	3%	46.6	9.61	37.9	9.11	20	1000	MC4	1960	1000	46	20.3
	LG350S2C(W)-G4	350	3%	46.8	9.67	38.1	9.20	20	1000	MC4	1960	1000	46	20.3
	LG355S2C(W)-G4	355	3%	47.0	9.74	38.2	9.30	20	1000	MC4	1960	1000	46	20.3
	LG360S2C(W)-G4	360	3%	47.2	9.80	38.4	9.38	20	1000	MC4	1960	1000	46	20.3

Note) MC4 formal name : PV-KST4 / 6II-UR, PV-KBT4 / 6II-UR

→ Plus (+) Connector : Female MC4 coupler (PV-KBT4/6II-UR)

→ Negative (-) Connector : Male MC4 coupler (PV-KST4/6II-UR)

A safety locking clip (MC PV-SSH4) may be required per article 690 of NEC 2008

# Dimensions of Modules

Unit: mm / in.

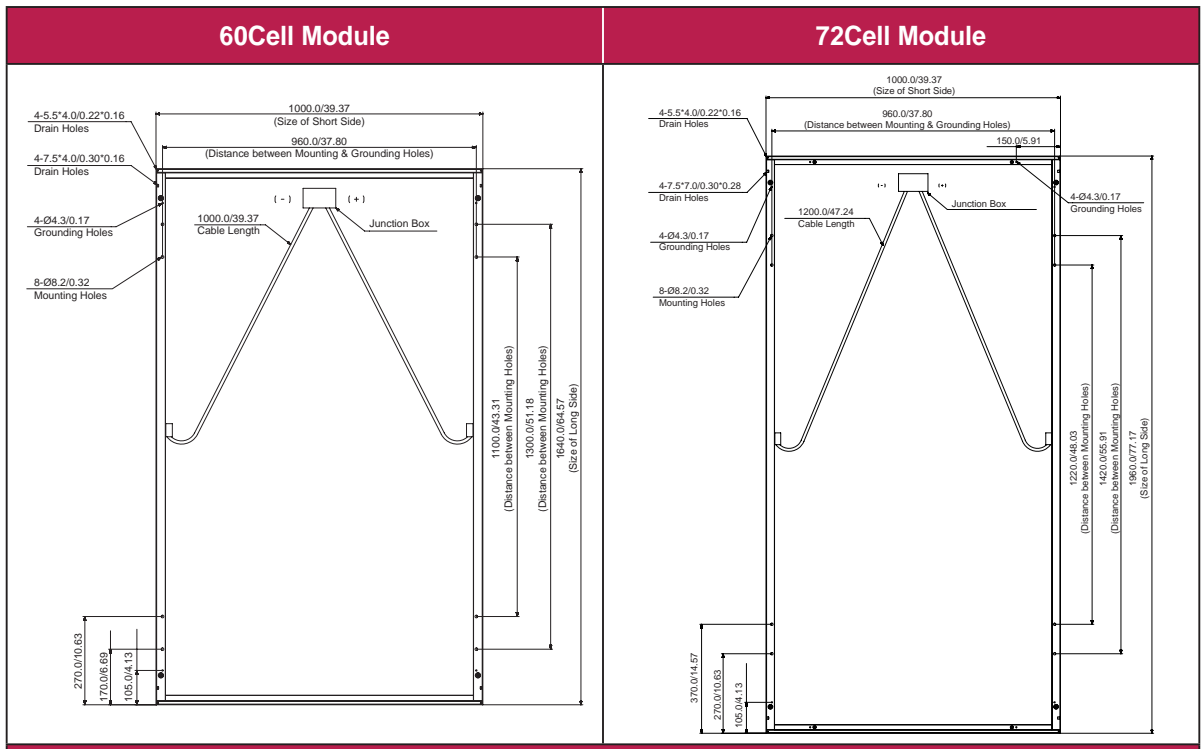

## 72Cell Module – only NEXTracker

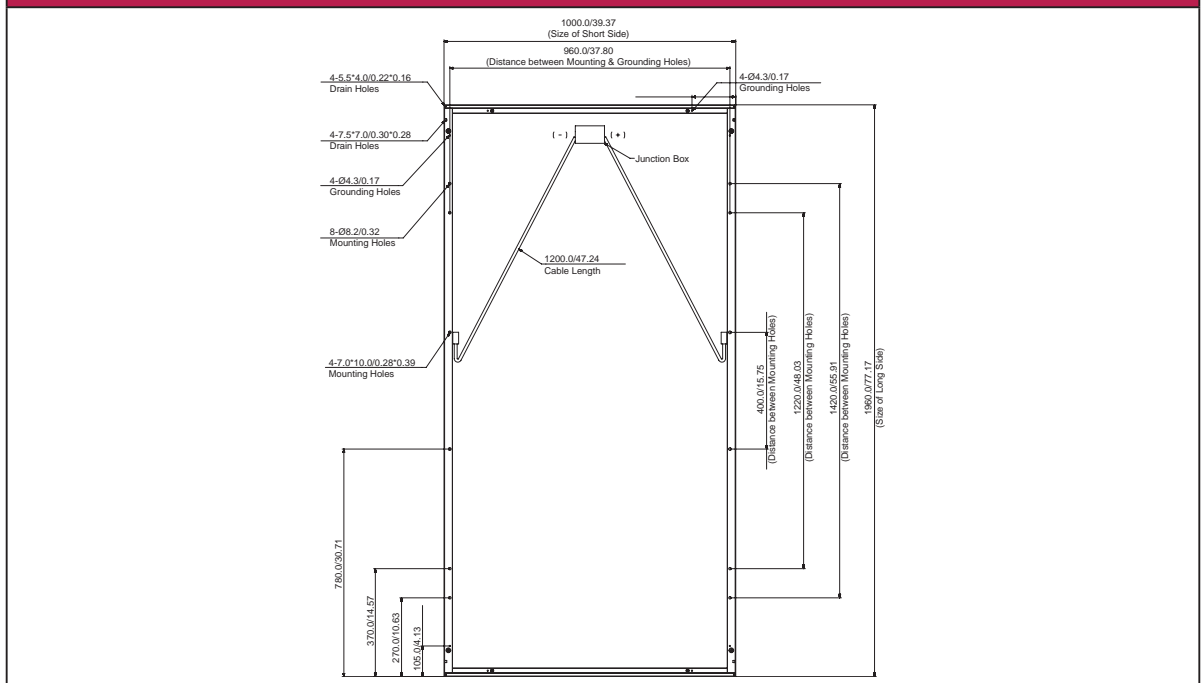

Note) Holder is for the convenient connection of junction box cable, but that does warranty if it is broken after installed.

# APPENDIX

## Mechanical Installation : 60Cell Model

Fig.1 Mounting Type		Fig.2 Clamping Type	
① : 170mm(6.7 in) ② : 270mm(10.6 in)	Front : 6000Pa(125psf) Rear : 5400Pa(113psf)	A : 150mm(5.9 in) B : 400mm(15.7 in)	Front : 6000Pa(125psf) Rear : 5400Pa(113psf)
Fig.3 Clamping Type		Fig.4 Clamping Type	
A : 150mm(5.9 in) B : 400mm(15.7 in)	Front : 6000Pa(125psf) Rear : 5400Pa(113psf)	A : 120mm(4.7 in)	Front : 1800Pa(37.5psf) Rear : 1800Pa(37.5psf)
		B : 150mm(5.9 in)	Front : 2850Pa(60psf) Rear : 2850Pa(60psf)
Fig.5 Clamping Type		Fig.6 Clamping Type	
A : 150mm(5.9 in) B : 400mm(15.7 in)	Front : 6000Pa(125psf) Rear : 5400Pa(113psf)	A : 120mm (4.7 in)	*4point(①) Front : 1800Pa(37.5psf) Rear : 1800Pa(37.5psf)
C : 120mm(4.7in)	Front : 3200Pa(67psf) Rear : 1800Pa(37.5psf)	A : 120mm B : 820 ±100mm (32.3±3.9 in)	6point(①+②) Front : 6000Pa(125psf) Rear : 5400Pa(113psf)

\* 4 point installation is allowed in the following cases:  
 1. Slope roof: If module is installed parallel to the rooftop.  
 2. Flat roof: If installed with an additional stand such as wind shield or deflector.

Note) All mechanical installation method(Fig.1 to Fig.6) in this appendix were not tested by Intertek.  
 (UL 1703, ULC 1703) It is evaluated by LG internal test.

# Mechanical Installation : 72Cell Model

Fig.1 Mounting Type		Fig.2 Clamping Type	
① : 270mm(10.6 in) ② : 370mm(14.6 in)	Front : 5400Pa(113psf) Rear : 4300Pa(90psf)	A : 250mm(9.8 in) B : 400mm(15.7 in)	Front : 5400Pa(113psf) Rear : 4300Pa(90psf)
Fig.3 Clamping Type		Fig.4 Clamping Type	
A : 250mm(9.8 in) B : 400mm(15.7 in)	Front : 5400Pa(113psf) Rear : 4300Pa(90psf)	A : 120mm(4.7 in)	Front : 1800Pa(37.5psf) Rear : 1800Pa(37.5psf)
		B : 250mm(9.8 in)	Front : 2850Pa(60psf) Rear : 2850Pa(60psf)
Fig.5 Clamping Type		Fig.6 Clamping Type	
A : 250mm(9.8 in) B : 400mm(15.7 in)	Front : 5400Pa(113psf) Rear : 4300Pa(90psf)	A : 120mm (4.7 in)	*4point(①)
C : 120mm(4.7in)	Front : 3200Pa(67psf) Rear : 1800Pa(37.5psf)	A : 120mm B : 980 ±100mm (38.6±3.9 in)	6point(①+②)
			Front : 1800Pa(37.5psf) Rear : 1800Pa(37.5psf)
			Front : 5400Pa(113psf) Rear : 4300Pa(90psf)

Note) All mechanical installation method(Fig.1 to Fig.7) in this appendix were not tested by Intertek. (UL 1703, ULC 1703) It is evaluated by LG internal test.

Fig7. Mounting Type

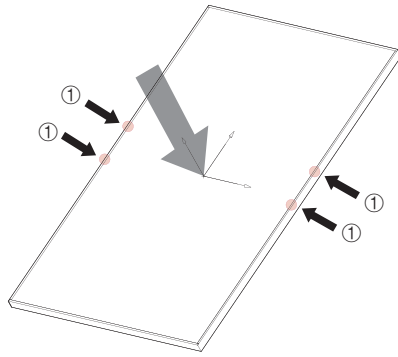

① : 780mm(30.7 in)

Front : 2250Pa(47psf)  
Rear : 2250Pa(47psf)

\* This method is used to tracking system ; ex)NEXTracker



## Alternate Equipment Grounding Devices

This appendix defines alternative grounding methods for LG PV modules and applies to the LG Module Install manual and listed manufacture's installation guide. These alternative grounding devices indicated on this page has been evaluated and approved by LG, not by ETL. If such devices want to be used to meet the requirement in UL 1703, some adequate tests shall be conducted in accordance with UL1703 additionally.

### Line of Devices

Products		Remark
Manufacture	Ground Devices	
Everest	- Everest Solar Universal Bonding Clamp	
IronRidge	- IronRidge IG (Integrated Grounding) Clamp / UFO Mid Clamp	
Unirac	- Unirac Bonding Mid Clamp / SunFrame Micro Rail / Wire Bonding Clip w/ 8 AWG	
Panel Claw	- Standard Claw / Long Claw / PolaBear III Claw	
Quickmount PV	- Quick Rack Panel Clamp	
SnapNrack	- SnapNrack Bonding Mid Clamp / SnapLink for RL system	
Ecolibrium	- EcoX Clamp and Coupling assembly / EcoFoot Clamp	
Pegasus	- Pegasus LightSpeed Corners	
Schletter	- Rapid Grounding Module Clamps	
Dynorax	- DynoBond	
Roof Tech	- Roof Tech Bonding Plate	
ILSCO	- ILSCO SGB-4 Solar Grounding Lug	
TYCO	- TYCO 2058729 / 2106831 SolarLock Grounding Assy	
Wiley Burndy	WEEB LUG / WEEB KMC in combination with Everest clamp / WEEB DMC in combination with IronRidge clamp / Wiley WEEB UMC or UGC-1 in combination with Unirac clamp / WEEB PMC in combination with Pro Solar clamp / WEEB DPW in combination with DPW Solar clamp	

### Important Notes

1. The NEC section 690.43 states, "Exposed non-current carrying metal parts of module frame, equipment and conductor enclosures shall be grounded in accordance with 250.134 or 250.136(A) regardless of voltage"
2. Functionality will not be guaranteed if reused.