





## LEDS-P

### LED tape



LEDS-P 4W/M IP00-WW

					<b>IP</b>	
LEDS-P 4W/M IP00-WW	<b>24010</b>	1m = 4	1m = 300	3000	00	5000
LEDS-P 4W/M IP00-CW	<b>24011</b>	1m = 4	1m = 300	6000	00	5000
LEDS-P 4W/M IP54-WW	<b>24012</b>	1m = 4	1m = 300	3500	54	5000
LEDS-P 4W/M IP54-CW	<b>24013</b>	1m = 4	1m = 300	5700	54	5000
LEDS-P 10W/M IP00 WW	<b>24120</b>	1m = 10	1m = 900	3000	00	5000
LEDS-P 10W/M IP00 CW	<b>24121</b>	1m = 10	1m = 900	6000	00	5000
LEDS-P 10W/M IP54 WW	<b>24122</b>	1m = 10	1m = 800	3500	54	5000
LEDS-P 10W/M IP54 CW	<b>24123</b>	1m = 10	1m = 800	5700	54	5000

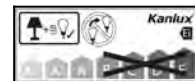

With the use of the highest quality materials, Kanlux LEDS-P tapes guarantee the best lighting parameters. Original 3M adhesive tape allows for installation on various surfaces, and EDISON brand diodes guarantee steadiness of lighting parameters. Depending on our needs and the place of use, we can select adequate power, tightness class and colour of light.

## LEDS-P

### LED tape

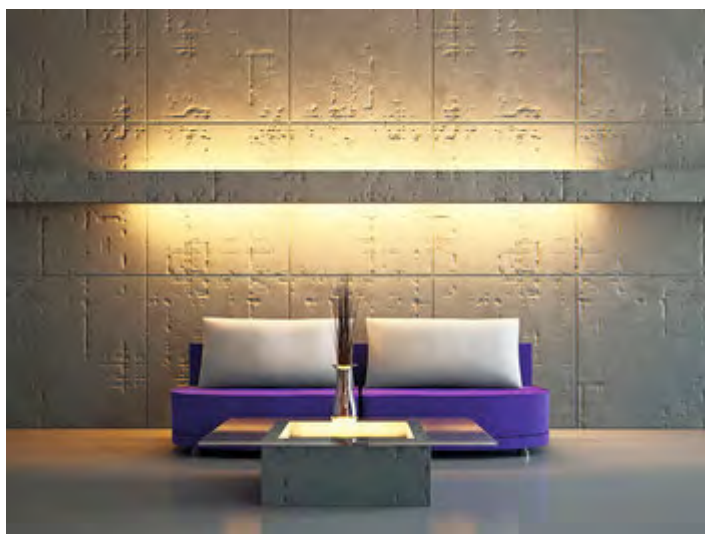

LEDS-P 4W/M IP00-WW



LEDS-P 4W/M IP00-CW



LEDS-P 4W/M IP54-WW



LEDS-P 4W/M IP54-CW



LEDS-P 10W/M IP00 WW



LEDS-P 10W/M IP00 CW



LEDS-P 10W/M IP54 WW



LEDS-P 10W/M IP54 CW

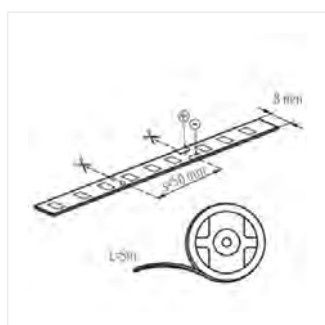

## LEDS-P

---

### LED tape

LEDS-P 4W, LEDS-P 10W

#### ACCESSORIES:

**19030** CONNECTOR 8 LED band connector, CONNECTOR 8 (19030)



**19032** CONNECTOR 8-CP LED band connector, CONNECTOR 8-CP (19032)



**19033** CONNECTOR 8-CPC LED band connector, CONNECTOR 8-CPC (19033)

